



Milling/Fräsen



ZCC Cutting Tools Europe GmbH

your Partner | your Value



WELCOME TO ZCC CUTTING TOOLS EUROPE

ZCC-CT, one of the World's leading carbide tooling manufacturers, welcomes you to its products. We are able to offer you a wide product range of high performance cutting tools at economic prices and a good supply service to support the production and productivity at your manufacturing facilities. You will find the main tool types in the various sections of the catalogue, Turning is in section A, Milling in section B and Drilling in section C of the catalogue.

We are looking forward to working with you and developing good cooperation together. Our team at ZCC Cutting Tools Europe is ready to support you in all of your requirements.



Member of Minmetals Group



EUROPEAN HEADQUARTER / HAUPTSITZ IN EUROPA:

ZCC Cutting Tools GmbH, Heltorfer Str.12, 40472 Düsseldorf, Germany

Tel.: +49 (0) 211/989240-0, Fax: +49 (0) 211/ 989240-111

E-Mail: info@zccct-europe.com, www.zccct-europe.com, www.zccct.com



HERZLICH WILLKOMMEN BEI ZCC CUTTING TOOLS EUROPE

ZCC-CT, einer der weltweit führenden Hartmetall-Werkzeughersteller, begrüßt Sie recht herzlich. Mit unserer umfangreichen Produktpalette an Hochleistungs-Zerspanungswerkzeugen und entsprechenden Serviceleistungen möchten wir gerne bei Ihnen die Bearbeitungssicherheit und die Wirtschaftlichkeit erhöhen. In Teil A des Katalogs finden Sie die Werkzeuge zum Drehen, in Teil B zum Fräsen und in Teil C zum Bohren.

*Wir freuen uns auf eine gute Zusammenarbeit.
Ihr Team von ZCC Cutting Tools Europe steht Ihnen als Partner zur Seite!*

Copyright Katalog
©2016 ZCC Cutting Tools Europe GmbH

All rights reserved. All descriptions and pictures are protected by copyright. Usage, modification and reproduction, completely or partially, without written permission are prohibited. Subject to technical changes and changes of the delivery program. No responsibility for errors and printing errors are accepted.

Alle Rechte vorbehalten. Alle Beschreibungen und Abbildungen sind urheberrechtlich geschützt. Die Verwendung, Modifikation und Vervielfältigung, ganz oder teilweise, ohne schriftliche Genehmigung sind untersagt. Technische Änderungen und Änderungen des Lieferprogrammes vorbehalten. Für Druckfehler und Irrtümer kein Gewähr.





Content Inhaltsangabe

A Turning Drehen A1-A384	General Turning Allgemeine Drehbearbeitung	A1 -A283
	Parting and Grooving Ab- und Einstechen	A284-A325
	Thread Turning Gewindedrehen	A326-A384
B Milling Fräsen B1-B536	Milling Indexable Tools Fräsen - WSP Werkzeuge	B1 -B242
	Milling - Solid Carbide Endmills Fräsen VHM - Schaftfräser	B243-B536
C Drilling / Reaming / Threading Bohren / Reiben / Gewinde C1-C174	Drilling - Solid Carbide Drills Bohren - VHM Bohrer	C1 -C121
	Drilling Indexable Tools Bohren - WSP Werkzeuge	C122-C140
	Reaming Reiben	C141-C152
	Threading - Solid Carbide Tools Gewinde - VHM Gewindebohrer	C153-C167
	Solid Carbide Threading Endmills VHM Gewindefräser	C168-C174
D	General Technical Information Allgemeine Technische Informationen	D1 -D28
Index		I01 -I14

WSP = Wendeschneidplatte VHM = Vollhartmetall



New XMP01

Grooving Milling Cutter
Bohrfräser





New **FMA11**

Face milling
Planfräser





New **SMP05**
Groove milling tools
Nutenfräser



QC
Series

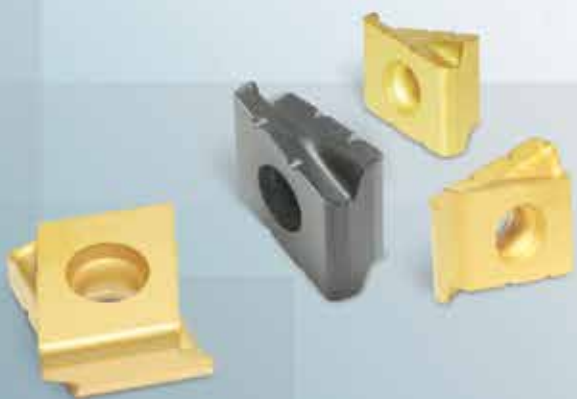

B B

Milling - Fräsen

Indexable Milling Tools

Indexable milling tools

Indexable milling inserts

Technical information

B1-B242

B1 - B199

B200 - B235

B236 - B242

Wendeschneidplatten Fräswerkzeuge

Wendescheidplatten Fräswerkzeuge

Fräswendescheidplatten

Technische Informationen

Solid Carbide End Mills

B244-B535

Vollhartmetall Schafffräser

New

EMP13



Milling · Fräsen

Indexable Milling Tools · Wendeplattenfräser

- B8-B9** Indexable milling tool family
Wendeplattenfräsprogramm
- B11-B18** Indexable milling tools overview
Wendeplattenfräser Übersicht
- B19** Milling insert grades overview
Fräswendeplatten Sorten Übersicht
- B20-B23** Grade classification for milling inserts
Sortenbezeichnung für Fräswendeplatten
- B26-B27** Indexable milling tools code key
Wendeplattenfräswerkzeuge ISO Kennzeichen
- B28-B199** Indexable milling tool
Wendeplattenfräser
 - B28-B94 Face milling
Planfräsen
 - B95-B118 Square shoulder milling
Eckfräsen
 - B119-B141 Profile milling
Profilfräsen
 - B142-B151 Side and face milling
Eck- und Planfräsen
 - B152-B160 Special milling (high feed)
Spezial Hochvorschubfräsen
 - B161-B163 Groove milling cutter
Bohrfräser
 - B164-B165 T-slot milling
T-Nuten Fräsen
 - B166-B170 Helical end mills
Walzenstirnfräser
 - B171-B175 Chamfer milling
Fasfräsen
 - B176-B199 QCH Series
QCH Serie
- B200-B201** Indexable milling inserts overview
Fräswendeplatten Übersicht
- B202-B203** Indexable milling inserts code key
Fräswendeplatten ISO Kennzeichen
- B204-B235** Milling inserts Specification
Fräswendeplatten Spezifikation
- B236-B242** Technical information
Technische Information

Indexable inserts milling tool Program Wendeplatten Fräsprogramm

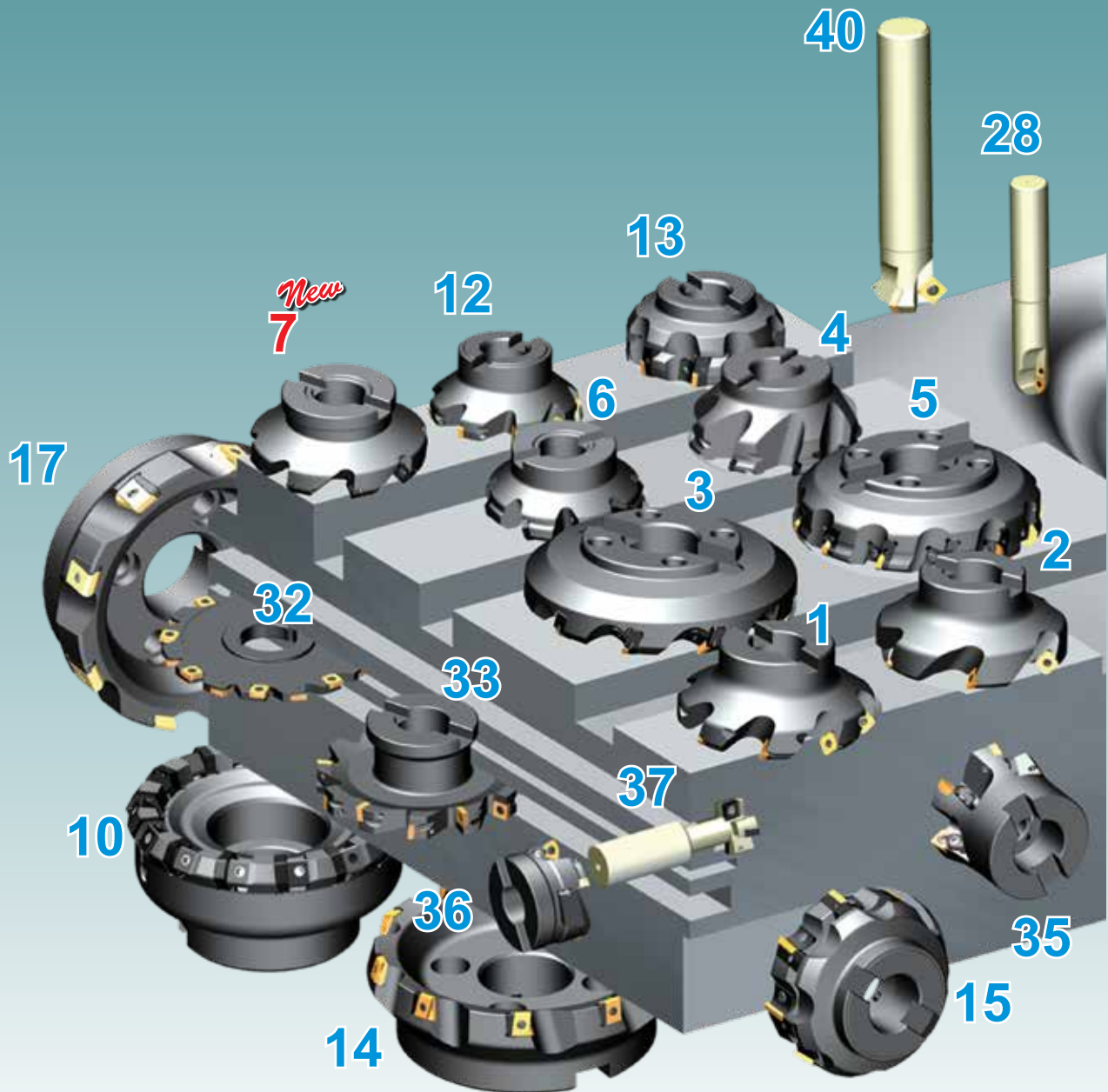

No. Nr.	Tool category Werkzeug Kategorie	Page Seite	No. Nr.	Tool category Werkzeug Kategorie	Page Seite	No. Nr.	Tool category Werkzeug Kategorie	Page Seite
1	FMA01	B28	9	FMD02(PN11)	B54	17	FMP03	B78
2	FMA02	B29	10	FMD02(HN09)	B57	18	FMR01	B80
3	FMA03	B33	11	FMD03	B59	19	FMR02	B83
4	FMA04(OFKT05**)	B36	12	FME02	B62	20	FMR03	B86
5	FMA04(OFKR07**)	B40	13	FME03	B64	21	FMR04	B90
6	FMA07	B43	14	FME04	B68	22	EMP01	B95
7	FMA11	B47	15	FMP01	B70	23	EMP02	B102
8	FMA12	B51	16	FMP02	B72	24	EMP03	B106

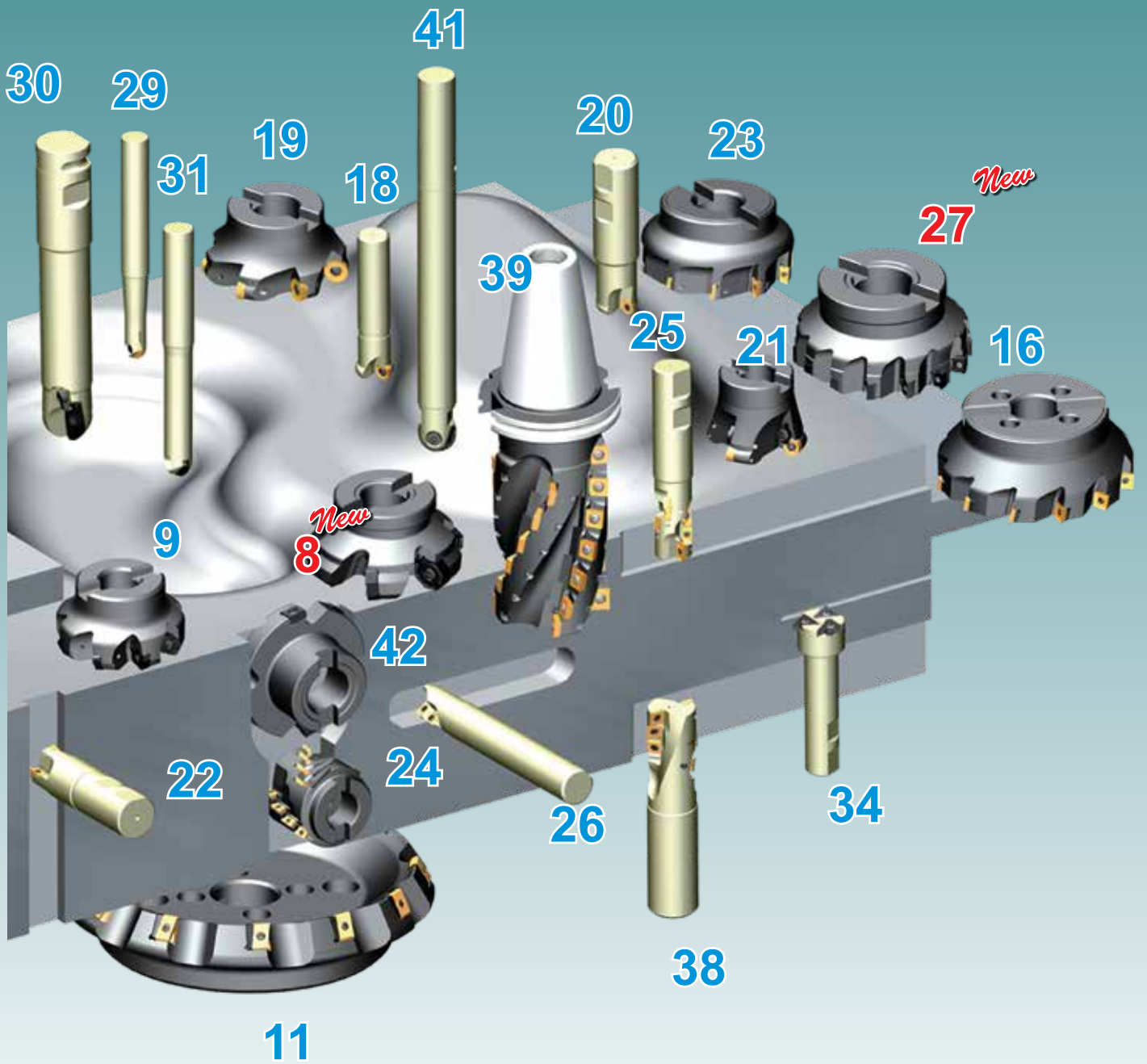









No. Nr.	Tool category Werkzeug Kategorie	Page Seite	No. Nr.	Tool category Werkzeug Kategorie	Page Seite	No. Nr.	Tool category Werkzeug Kategorie	Page Seite
25	EMP04	B107	33	SMP03	B146	40	CM*01	B171
26	EMP05	B111	34	SMP05	B149	41	QCH	B176
27	EMP13	B114	35	XMR01(SDMT**)	B152	42	XMP01	B162
28	BMR01	B119	36	XMR01(WPGT**)	B155			
29	BMR02	B121	37	TMP01	B164			
30	BMR03	B123	38	HMP01(Ø40-Ø50)	B166			
31	BMR04	B135		HMP01(Ø50-Ø80)	B167			
32	SMP01	B143	39	HMP01 EC(Ø50-Ø80)	B168			



New FMA12



Face milling Planfräsen		Serie Serie	Approach Angle / max. depth of cut Einstellwinkel/ max. Schnitttiefe	Insert WSP	Application Anwendung	Features Merkmale	
Face milling Planfräsen		FMA01	Kr=45° a _p max=6.0	SEET12T3-DF/DM/DR SEET12T3-CF/CM/CR SEET12T3-EF/EM SEET12T3-LH SEET12T3-W	General face milling of: Steel, alloy steel, stainless steel, cast iron, aluminium alloy, high temperature alloy Allgemeines Planfräsen von: Stahl, leg. Stahl, rostfr. Stahl, Grauguss, Alu.-legierungen, hochtemperaturbeständige Legierungen	<ul style="list-style-type: none"> • Diameter range Ø50-Ø315 • Large rake angle makes cutting more light and fast • Wide applications by using available inserts with different chipbreaker • Adopting wiper inserts improve surface quality • Durchmesserbereich: 50 – 315 mm weichschneidende Fräser mit großer, positiver Schneidengeometrie. • Großes Anwendungsgebiet durch unterschiedliche Spanbrecherausführung • Wiper-Wendeschneidplatten für beste Oberflächenqualität 	
		FMA02	Kr=45° a _p max =6.0	SEET12T3-DF/DM/DR SEET12T3-CF/CM/CR SEET12T3-EF/EM SEET12T3-LH SEET12T3-W	General face milling of: Steel, alloy steel, stainless steel, cast iron, aluminum alloy, high temperature alloy Allgemeines Planfräsen von: Stahl, leg. Stahl, rostfr. Stahl, Grauguss, Alu.-legierungen, hochtemperaturbeständige Legierungen	<ul style="list-style-type: none"> • Diameter range Ø50-Ø125 • Large rake angle makes cutting more light and fast • Wide applications by using available inserts with different chipbreaker • Coarse and differential pitch, reduce vibration. • Durchmesserbereich: 50 – 125 mm weichschneidende Fräser mit großer, positiver Schneidengeometrie. • Großes Anwendungsgebiet durch unterschiedliche Spanbrecherausführung • Weite und Differential-Teilung zur Vermeidung von Vibrationen 	
		FMA03	Kr=45° a _p max=5.5	SE*N120*3AF** SE*R1203AF**	General face milling of steel, stainless steel, cast iron	Allgemeine Planfräsbear. von Stahl, rostfr. Stahl und Grauguss	<ul style="list-style-type: none"> • Diameter range Ø80-Ø315 • Large rake angle makes cutting more light and fast • Top clamping reduces vibrations • Durchmesserbereich: 80 – 315 mm weichschneidende Fräser mit großer, positiver Schneidengeometrie. • Großes Anwendungsgebiet durch unterschiedliche Spanbrecherausführung • Topklammerung zur Vermeidung von Vibrationen
			Kr=45° a _p max=7.5	SE*N1504AF** SE*R1504AF**			
		FMA04	Kr=45° a _p max=3.5	OFKT05T3-DF/DM OFKT05T3-LH	Face milling of steel, alloy steel, cast iron, aluminum alloy Planfräsen von Stahl, leg. Stahl Grauguss und Alu.-legierungen	Face milling of steel, alloy steel and cast iron Planfräsen von Stahl, leg. Stahl und Grauguss	<ul style="list-style-type: none"> • Diameter range Ø50-Ø160 • High economy milling tool with 8 cutting edges • Screw clamping, high precision • Durchmesserbereich: 50 – 160 mm • Hochwirtschaftlicher Fräser mit 8 Schneidkanten • Schraubenklammerung mit hoher Präzision.
			Kr=45° a _p max =5.0	OFKR0704-DF/DM/LH			
		FMA07 <i>New!</i>	Kr=45° a _p max=4.0	ONHU060408-PF/PM	Face milling of steel, alloy steel, cast iron	Planfräsen von Stahl und Grauguss	<ul style="list-style-type: none"> • Diameter range Ø25-Ø50 • High economy milling tool with 16 cutting edges • Durchmesserbereich: 25 – 50 mm • Hochwirtschaftliche Fräser mit 16 Schneidkanten
			Kr=45° a _p max=5.0	ONHU08T508-PF/ PM/W			
		FMA11 <i>New!</i>	Kr=45° a _p max=5.5	SNEG 1205ANR-GM/ GR/W	Face milling of steel, alloy steel and cast iron Planfräsen von Stahl und Leg.Stahl Grauguss	<ul style="list-style-type: none"> • Diameter range Ø63-Ø315 • 8 cutting edge • Inserts with big rake angle cutting lightly reducing power consumption • Milling cutter with double negative angle and with thicker inserts for high stability and big cutting depth. • Inserts with wiper cutting edge for good surface quality. • Normal and close pitch • Durchmesserbereich: Ø63 – Ø315 mm • 8 Schneidkanten • Wandeschneidplatte mit großen Spanwinkel zur Reduzierung der Schnittkräfte • Doppelseitige, extra dickewandescheidplatte für große Spanliefen bei hoher bruchssicherheit • Wiper Geometrie für beste Oberflächengüte • Normale und Enge Teilung 	
			Kr=45° a _p max=7.0	SNEG 1506ANR-GM/ GR/E			
		Kr=45° a _p max=9.0	SNEG 1907ANR-GR				









Milling - Fräsen









General Technical Information - Allgemeine Technische Informationen

B

Milling Tools
Fräser

Face milling - Planfräser

Serie Serie	Approach Angle / max. depth of cut Einstellwinkel/ max. Schnitttiefe	Insert WSP	Application Anwendung	Features Merkmale
FMA12 <i>New!</i>  B51	Kr=45° a _p max=5.0	ONHU08T624R-GM	Face milling of steel, alloy steel and cast iron Planfräsen von Stahl und Leg. Stahl Grauguss	<ul style="list-style-type: none"> Diameter range Ø63-Ø315 Unique 3-dimensional edge, 16 edges for outstanding economy Double negative rake angle, in combination with helical insert structure, achieves double positive axial angle, which will help reduce cutting resistance and improve chip evacuation. Durchmesserbereich: Ø63 – Ø315 mm Einzigartige, dreidimensionale Schneidkante, 16 Schneidkanten für hervorragende Wirtschaftlichkeit. Doppelt negative Spanwinkel in Kombination mit einer spiralförmigen Struktur führen zu doppelt positiven Achswinkeln, die zu einer Reduzierung des Schneidwiderstandes führen und die Spanabfuhr verbessern.
FMD02  B54-B56	Kr=67° a _p max=5.0	PNEG110512R/L-CF/ CM/CR/PF/PM/PR	Face milling of steel, alloy steel and cast iron Planfräsen von Stahl, leg. Stahl und Grauguss	<ul style="list-style-type: none"> Diameter range Ø50-Ø315 High economy milling tool with 10 cutting edges Normal and close pitch Left on demand Durchmesserbereich: 50 – 315 mm Hochwirtschaftliche Fräser mit 10 Schneidkanten Normale und Egel Teilung Links Lauf auf Anfrage erhältlich
FMD02  B57	Kr=55° a _p max=6.0	HNEX090512-DF/DM HNEX090512-DR	Face milling of cast iron Planfräsen von Grauguss	<ul style="list-style-type: none"> Diameter range Ø80-Ø315 Top clamping is easy to assemble and disassemble High economy milling tool with 12 cutting edges Durchmesserbereich: 80 – 315 mm Topklemmsystem zum einfachen Wendeschneidplatten-Wechsel Hoch wirtschaftlich durch doppelseitige 12 Schneiden-Platte
FMD03  B59	Kr=60° a _p max=12.0 Kr=60° a _p max=17.0	LNKT2007DN-ZR LNKT2510-ZR	Heavy-duty face milling of steel, alloy steel and cast iron Schwerzer- spanungsfräsen von Stahl, leg. Stahl und Grauguss	<ul style="list-style-type: none"> Diameter rang Ø100-Ø400 Double positive rake angle reduces the cutting force Suitable for heavy machining with big cutting depth Easy to assemble and clamp inserts Durchmesserbereich: 100 – 400 mm Doppelt positive Schneidwinkel zur Reduzierung der Schnittkräfte Anwendung zur Schwerzerspannung bei hohen Schnitttiefen Einfache und stabile Wendeschneidplatten-Klemmung
FME02  B62	Kr=75° a _p max=6.0	SPKW1204EDFR SPKW1204EDSR SPKT1204EDR	Face milling of steel, alloy of steel and cast iron Planfräsen von Stahl, leg. Stahl und Grauguss	<ul style="list-style-type: none"> Diameter range Ø50-Ø125 Kr 75°, general face milling Wide applications by using inserts with different chipbreakers Durchmesserbereich: 50 – 125 mm Anstellwinkel 75 Grad, Allgemeines Planfräsen Weites Anwendungsgebiet durch Einsatz von Wendeschneidplatten mit unterschiedlichen Spanbrechern
FME03  B64	Kr=75° a _p max=6.0 Kr=75° a _p max=8.0	SP*N1203(1504)ED** SP*R1203(1504)ED** SP*R1204ED** SPEX1203EDL/R-1 SP*N1504ED** SP*R1504ED** SPEX1504EDL/R-1	General face milling of steel, alloy steel and cast iron Allgemeines Planfräsen von Stahl, leg. Stahl und Grauguss	<ul style="list-style-type: none"> Diameter range Ø80-Ø315 Kr 75°, general face milling Top clamping is easy to assemble and disassemble Left on demand Durchmesserbereich: 80 – 315 mm Einstellwinkel 75 Grad zum allgemeinen Planfräsen Top Klemmsystem zum einfachen Wendeschneidplattenwechsel. Links Lauf auf Anfrage erhältlich
FME04  B68	Kr=75° a _p max=10.0	LNKT1506EN-ZR	Heavy-duty face milling of steel, alloy steel and cast iron Schwerzer- spanungsfräsen von Stahl, leg. Stahl und Grauguss	<ul style="list-style-type: none"> Diameter rang Ø125-Ø315 Double positive rake angle reduces the cutting force Suitable for heavy machining with big cutting depth Durchmesserbereich: 125 – 315 mm Doppelt positive Schneidwinkel zur Reduzierung der Schnittkräfte Anwendung zur Schwerzerspannung bei hohen Schnitttiefen
FMP01  B70	Kr=90° a _p max=18.0	TPKN2204PD**	Face milling of steel, alloy steel and cast iron Planfräsen von Stahl, leg. Stahl und Grauguss	<ul style="list-style-type: none"> Diameter range Ø80-Ø315 Kr 90°, square shoulder milling Top clamping is easy to assemble and disassemble Durchmesserbereich: 80 – 315 mm Einstellwinkel 90 Grad zum allgemeinen Planfräser Top-Klemmsystem zum einfachen Wendeschneidplattenwechsel.

Face milling - Planfräser		Serie Serie	Approach Angle / max. depth of cut Einstellwinkel/ max. Schnitttiefe	Insert WSP	Application Anwendung	Features Merkmale
 B72	FMP02	Kr=90° a _{pmax} =6.7	SEET09T308PER-PF/PM SEET09T308PER-PR	Face and square shoulder milling of steel, alloy steel, stainless steel cast iron and Alu.	<ul style="list-style-type: none"> • Diameter range Ø50-Ø315 • Kr 90°, for square shoulder milling and face milling • Different pitch design: coarse pitch, close pitch and extra close pitch • High precision insert for, high surface quality • Optimized chipbreaker and grade, for finish machining, semi-finish machining and rough machining. 	
		Kr=90° a _{pmax} =10.8	SEET120308PER-PF/PM SEET120308PER-PR SEET120308-LH	Plan- und Eckfräsen von Stahl, leg. Stahl, rostfr. Stahl Grauguss und Alu.	<ul style="list-style-type: none"> • Durchmesserbereich: 50 – 315 mm • Einstellwinkel 90 Grad zum Eck- und Planfräsen • Unterschiedliche Teilung: weit, eng und extra eng • Präzisionsschneidplatten zur Erzielung hoher Oberflächenqualität • Optimale Spanbrecher und Hartmetallsorten zum Schlichten, mittlere Bearbeitung und Schruppen. 	
 B78	FMP03	Kr=89° a _{pmax} =7	LNKT120608-ZR	Heavy duty face milling of steel, alloy steel, stainless steel and cast iron Schwerzerspa- nung von Stahl, leg. Stahl, rostfr. Stahl und Grauguss	<ul style="list-style-type: none"> • Diameter range Ø50-Ø315 • Kr 90°, for square shoulder milling and face milling with big cutting depth • positive rake reduces the cutting force 	
		Kr=89° a _{pmax} =8	LNKT1506EN-ZR			
		Kr=89° a _{pmax} =12	LNKT2007DN-ZR			
		Kr=89° a _{pmax} =15	LNKT2510-ZR			
 B80	FMR01	a _{pmax} =5.0	RCKT10T3MO-DM	Profile milling of steel, alloy steel, stainless steel and cast iron	<ul style="list-style-type: none"> • Diameter range Ø25-Ø50 • R-type inserts possess stronger cutting edges • Suitable for machining curved surface of mould • Economical milling cutters with screw clamping 	
		a _{pmax} =6.0	RCKT1204MO-DM/DR/ ER RCGX1204MO-LH	Formfräsen von Stahl, leg. Stahl, rostfr. Stahl und Grauguss	<ul style="list-style-type: none"> • Durchmesserbereich: 25 – 50 mm • Radiusfräser mit stabiler Schneidkante • Einsatz zur Bearbeitung von Formen und Gesenken • Wirtschaftliche Fräser mit Schraubenklammerung 	
 B83	FMR02	a _{pmax} =6.0	RCKT1204MO-DM/DR/ER/ NM RCMW1204MO-PCBN	Face milling and profile milling of steel, alloy steel, stainless steel and cast iron Plan- und Formfräsen von Stahl, leg. Stahl, rostfreiem Stahl und Grauguss	<ul style="list-style-type: none"> • Diameter range Ø50-Ø250 • R-type inserts possess stronger cutting edges • Suitable for machining curved surface of mould • Economical milling tools with screw clamping 	
		a _{pmax} =8.0	RCKT1606MO-DM/DR/ER			
		a _{pmax} =10.0	RCKT2006MO-DM/DR/ER			
 B86	FMR03	a _{pmax} =4.0	RDKW0702MO RDKW0803MO RDKW1003MO	Profile milling of steel, alloy steel, stainless steel and cast iron Formfräsen von Stahl, leg. Stahl, rostfreiem Stahl und Grauguss	<ul style="list-style-type: none"> • Diameter range Ø15-Ø50 • R-type inserts possess stronger cutting edges • Suitable for machining curved surface of mould • Economical milling tools with screw clamping 	
		a _{pmax} =5.0	RDKW10T3MO			
		a _{pmax} =6.0	RDKW1204MO			
 B88	FMR03	a _{pmax} =3.5	RDKW0702MO	Formfräsen von Stahl, leg. Stahl, rostfreiem Stahl und Grauguss	<ul style="list-style-type: none"> • Durchmesserbereich: 15 – 50 mm Radiusfräser mit stabiler Schneidkante • Einsatz zur Bearbeitung von Formen und Gesenken • Wirtschaftliche Fräser mit Schraubenklammerung 	
		a _{pmax} =5.0	RDKW1003MO			
 B90	FMR04	a _{pmax} =6.0	RDKW1204MO RDKW12T3MO	Face milling and profile milling of steel, alloy steel, stainless steel and cast iron	<ul style="list-style-type: none"> • Diameter range Ø42-Ø200 • R-type inserts possess stronger cutting edge • Suitable for machining curved surface of mould 	
		a _{pmax} =8.0	RDKW1604MO RDKW1605MO			
		a _{pmax} =10.0	RDKW2006MO			
 B92	FMR04	a _{pmax} =5.0	RDKW1003MO	Plan- und Formfräsen von Stahl, leg. Stahl, rostfreiem Stahl und Grauguss	<ul style="list-style-type: none"> • Durchmesserbereich: 42 – 200 mm • Radiusfräser mit stabiler Schneidkante • Einsatz zur Bearbeitung von Formen und Gesenken • Wirtschaftliche Fräser mit Schraubenklammerung 	
		a _{pmax} =6.0	RDKW12T3MO			
		a _{pmax} =8.0	RDKW1604MO			









Milling - Fräsen







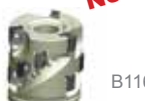

General Technical Information - Allgemeine Technische Informationen

B

Milling Tools
Fräser

Square shoulder milling - Eckfräsen

Serie Serie	Approach Angle / max. depth of cut Einstellwinkel/ max. Schnitttiefe	Insert WSP	Application Anwendung	Features Merkmale
EMP01  B95	Kr=90° a _{pmax} =10.5	APKT11T3**-PF/PM/ PR/LH/APF/APM/ALH	Multi-function milling of steel, alloy steel, stainless steel, cast iron and Al alloy Universelles Fräsen von Stahl, leg. Stahl, rostfr. Stahl, Grauguss und leg. Alu.	<ul style="list-style-type: none"> Two mounting modes: Straight shank and Weldon shank, Diameter range Ø12-Ø63. Kr 90° , for square shoulder milling, slot milling, ramp milling etc. Wiper inserts also suitable for face milling. Inserts with 3D helical cutting edge, less cutting force. Round grinded insert available Zwei Aufnahmeversionen: Zylinderschaft u. Weldon. Durchmesserbereich: 12 – 63 mm. Einstellwinkel 90 Grad, zum Eck-, Nuten-, Tauchfräsen etc. Wiper-Schneidplatten zum Planfräsen. Schneidplatte mit 3-D Spiral-Schneide zur Reduzierung der Zerspanungskräfte. Umfang geschliffenen Platten verfügbar. (APF/ALH)
	Kr=90° a _{pmax} =15.5	APKT16****- PF/PM/ PR/LH/APF/APM/ALH	Face milling of steel, alloy steel, stainless steel, cast iron and Al alloy Universelles Fräsen von Stahl, leg. Stahl, rostfr. Stahl, Grauguss und leg. Alu.	<ul style="list-style-type: none"> Diameter range Ø40-Ø250. Kr 90° , for square shoulder milling. Wiper inserts also suitable for face milling. Inserts with 3D helical cutting edge, less cutting force. Durchmesserbereich: 40 – 250 mm. Einstellwinkel 90 Grad zum Eckfräsen. Wiper-Schneidplatten zum Planfräsen Schneidplatte im 3-D Design. Zirkularschneide zur Reduzierung der Zerspanungskräfte.
EMP02  B102	Kr=90° a _{pmax} =10.5	APKT11T3**-PF/PM/ PR/LH/APF/APM/ALH	Adopting large cutting depth, for milling of steel, alloy steel, stainless steel, cast iron and Al alloy Fräsen mit großen Schnittiefen von Stahl, leg. Stahl, rostfr. Stahl, Grauguss und leg. Alu.	<ul style="list-style-type: none"> Diameter range Ø50-Ø100 End milling tools with positive helical angle, good chip removal. For side face milling and slot machining Close pitch, high machining efficiency. Durchmesserbereich: 50 – 100 mm. Eckfräser mit pos. Zirkularwinkel und guter Spanabfuhr. Eck- und Nutenfräsen. Enge Teilung zur Erreichung hoher Bearbeitungswirtschaftlichkeit.
EMP03  B106	Kr=90° a _{pmax} =39.0	APKT11T3**-PF/PM/ PR/LH/APF/APM/ALH	Adopting large cutting depth, for milling steel, alloy steel, stainless steel, cast iron and Al alloy. Fräsen mit großen Schnittiefen von Stahl, leg. Stahl, rostfr. Stahl, Grauguss und leg. Alu.	<ul style="list-style-type: none"> Diameter range Ø20-Ø40 End milling tools with positive helical angle, good chip removal For side face milling and slot machining Close pitch, high machining efficiency. Durchmesserbereich: 20 – 40 mm. Schafffräser mit pos. Zirkularwinkel und guter Spanabfuhr. Eck- und Nutenfräsen. Enge Teilung zur Erreichung hoher Bearbeitungswirtschaftlichkeit.
EMP04  B107	Kr=90° a _{pmax} =58.0	APKT11T3**-PF/PM/ PR/LH/APF/APM/ALH	Multi-function milling of steel alloy steel, stainless steel and cast iron Multi-Funktionsfräser von Stahl, leg. Stahl, rostfr. Stahl und Grauguss	<ul style="list-style-type: none"> Diameter range Ø25-Ø40 End edge over center, for plunge milling. Durchmesserbereich: 25 – 40 mm. Zentrum-Schneide (über Mitte) zum Tauchfräsen.
EMP05  B111	Kr=90° a _{pmax} =40.0	APMT1135PDR APMT160408PDER	Multi-function milling of steel alloy steel and cast iron	<ul style="list-style-type: none"> Diameter range Ø25-Ø200 Extra thick inserts with a positive soft cutting geometry reduces the cutting resistance and improves the wear resistance at the same time. Specially designed cutting edges with high precision control can achieve high quality 90° square shoulder milling.
EMP13 New!  B114  B115	Kr=90° a _{pmax} =11.2	ANGX1105**PNR-GM/ LH	Multi-Funktionsfräser von Stahl, leg. Stahl und Grauguss	<ul style="list-style-type: none"> Diameter range Ø25-Ø200 Extra dicke Wendeschneidplatte mit einer positiv weich schneidenden Geometrie reduziert den Schneidwiderstand bei gleichzeitiger Verbesserung der Bruchfestigkeit. Speziell entwickelte Schneidkanten mit hoher Präzisionskontrolle für qualitativ hochwertiges 90° Eckfräser.
	Kr=90° a _{pmax} =14.5	ANGX1506**PNR-GM/ LH		
EMP13 New!  B116  B117	Kr=90° a _{pmax} =43-64	ANGX1105**PNR-GM/ LH	Multi-Funktionsfräser von Stahl, leg. Stahl und Grauguss	<ul style="list-style-type: none"> Diameter range Ø25-Ø200 Extra dicke Wendeschneidplatte mit einer positiv weich schneidenden Geometrie reduziert den Schneidwiderstand bei gleichzeitiger Verbesserung der Bruchfestigkeit. Speziell entwickelte Schneidkanten mit hoher Präzisionskontrolle für qualitativ hochwertiges 90° Eckfräser.
	Kr=90° a _{pmax} 40-53	ANGX1506**PNR-GM/ LH		

Serie Serie	Approach Angle / max. depth of cut Einstellwinkel/ max. Schnitttiefe	Insert WSP	Application Anwendung	Features Merkmale
BMR01  B119		ZDET**CYR** ZPNT2204CYR** SPMT060304 SDMT**	Profile milling of steel, stainless steel and cast iron Formfräsen von Stahl, rostfreiem Stahl und Grauguss.	<ul style="list-style-type: none"> • Diameter range Ø20-Ø63 • Very suitable for rough machining large mold • Ball nose cutter with 3-cutting-edges inserts, perfect economical efficiency • Durchmesserbereich: 20 – 63 mm • Besonders geeignet für die Schruppbearbeitung von großen Formen • Radiusfräser mit 3 Schneidkanten pro Schneidplatte. • Hohe Wirtschaftlichkeit
BMR02  B121		ROHX**	Profile milling of steel, stainless steel and cast iron Formfräsen von Stahl, rostfreiem Stahl und Grauguss.	<ul style="list-style-type: none"> • Diameter range Ø12-Ø20 • Applied for profile finish machining • Good assembly stability. • Insert with two cutting edges, perfect economical efficiency. • Durchmesserbereich: 12 – 20 mm • Schlichtbearbeitung von Formen • Hohe Fräserstabilität • Schneidplatte mit 2 Schneidkanten • Hohe Wirtschaftlichkeit
BMR03  B123  B124  B125  B126	Cutting depth: see the detailed information about tool specifications Schnitttiefe: siehe detaillierte Info in der Werkzeug- spezifikation.	XPHT**R**- GM	Profile milling of steel, stainless steel and cast iron Formfräsen von Stahl, rostfreiem Stahl und Grauguss.	<ul style="list-style-type: none"> • Diameter range Ø16-Ø50 • Very suitable for rough machining moulds • Equipped with 3D chipbreaker inserts, high circular edge precision. • Tool body with high rigidity • Durchmesserbereich: 16 – 50 mm • Besonders geeignet für das Schruppfräsen von Formen. • 3-D Spanbrecher für hohe Rundlaufgenauigkeit • Werkzeugkörper mit hoher Stabilität
BMR04  B135  B136		ZOHX**	Profile milling of steel, stainless steel and cast iron Formfräsen von Stahl, rostfreiem Stahl und Grauguss.	<ul style="list-style-type: none"> • Diameter range Ø12-Ø32 • High precision, for finish profile machining. • Two types of chipbreaker, used at different machining condition • High assembling precision, good stability. • Durchmesserbereich: 12 – 32 mm • Hohe Präzision zur Fertigbearbeitung beim Formfräsen. • 2 Spanbrechergeometrien für unterschiedliche Anwendungen • Hohe Fräserstabilität und Präzision.











Profile milling
Formfräse







Milling - Fräsen

General Technical Information - Allgemeine Technische Informationen

B

Milling Tools
Fräser

	Serie Serie	Approach Angle / max. depth of cut Einstellwinkel/ max. Schnitttiefe	Insert WSP	Application Anwendung	Features Merkmale
Slot milling Nutenfräsen	SMP01  B143  B144	Cutting depth: see the detailed information about tool specifications	XSEQ12**	Slot milling of steel, stainless steel and cast iron. Nutenfräsen von Stahl und Grauguss	<ul style="list-style-type: none"> • Diameter range Ø63-Ø250 • Two mounting types • Groove width range : 4, 5, 6, 7, 8mm <ul style="list-style-type: none"> • Durchmesserbereich Ø63-Ø250 • Zwei Aufnahme Typen • Nutenbreiten Bereich : 4, 5, 6, 7, 8mm
	SMP03  B146  B147				
	SMP05 New!  B149	Cutting depth: see the detailed information about tool specifications Schnitttiefe: siehe detaillierte Info in der Werkzeug- spezifikation.	QC16L** QC22L**	Slot milling of steel, stainless steel and cast iron. Nutenfräsen von Stahl , rostfreiem Stahl und Grauguss	<ul style="list-style-type: none"> • Diameter range Ø25-Ø44 • Durchmesserbereich Ø25-Ø44
Special milling (high feed) Spezialfräsen für hohe Vorschübe	XMR01  B152  B153  B155  B156	Cutting depth: see the detailed information about tool specifications Schnitttiefe: siehe detaillierte Info in der Werkzeug- spezifikation.	SDMT**DM/ PM	Face and profile milling of steel, stainless steel and cast iron Plan- und Formfräsen von Stahl, rostfreiem Stahl und Grauguss	<ul style="list-style-type: none"> • Diameter range Ø20-Ø160 • High economy • Two mounting types: Straight shank and Arbor • The cutting forces are decomposed effectively, realize cutting with high feed rate. • For plunge milling • Double clamping, firm and reliable. <ul style="list-style-type: none"> • Durchmesserbereich Ø20-Ø160 • High wirtschaftlichkeit • als Schaft- und Aufsteckfräser • Die Schnittkräfte werden axial konzentriert. Der Fräser ist für hohe Vorschübe geeignet. • Tauchfräsen möglich. • Doppeltes Klemmsystem für WSP.
			WPGT**ZSR/ ZSR-PM	Face and profile milling of steel, stainless steel and cast iron Plan- und Formfräsen von Stahl, rostfreiem Stahl und Grauguss	<ul style="list-style-type: none"> • Diameter range Ø20-Ø160 • Stable indexable cutting insert • Two mounting types: Straight shank and Arbor • The cutting forces are decomposed effectively, realize cutting with high feed rate. • Double clamping, firm and reliable. <ul style="list-style-type: none"> • Durchmesserbereich Ø20-Ø160 • Stabile wendeschneid platte • als Schaft und Aufsteckfräser • Die Schnittkräfte werden axial konzentriert. DerFräser ist für hohe Vorschübe geeignet. • Doppeltes Klemmsystem für WSP.
	XMP01 New!  B162	Kr=90° a _{pmax} =15~90	CNE121006A/B	Groove milling of steel, stainless steel and cast iron Bohrfräsen von Stahl, rostfreiem Stahl und Grauguss	<ul style="list-style-type: none"> • Diameter range Ø80-Ø400 • Kr=90° • Good for grooving big holes with helix interpolations. • Two types of vertical inserts for different material CNE 121006A with sharper cutting edge. CNE 121006B with chamfe <ul style="list-style-type: none"> • Durchmesserbereich Ø80-Ø400 • Kr=90° • Geeignet für das Bohrfräsen von großen Bohrungen mit Helixinterpolation • Zwei WSP-Geometrie für verschiedene Materialien und Bearbeitungen. CNE 121006A mit schäferen Schneidkanten. CNE 121006A mit Schutzschneidkanten.









	Serie Serie	Approach Angle / max. depth of cut Einstellwinkel/ max. Schnitttiefe	Insert WSP	Application Anwendung	Features Merkmale
T-slot milling T-Nutenfräsen	TMP01  B164	Kr=90°	MPHT**	Machining T slot in cast iron T-Nuten von Gusseisen	<ul style="list-style-type: none"> • Diameter range Ø21-Ø60 • Machining the T-slot with size range 12, 14, 18, 22, 28, 36 mm. • 86° rhombic inserts with positive angle. • Durchmesserbereich Ø21-Ø60 • T-Nutenfräsen im Bereich von 12, 14, 18, 22, 28, 36mm. • 86° rhombische WSP mit positivem Winkel.
Helical end mills Walzenstirnfräser	HMP01  B166	Kr=90° a _{pmax} =55	APKT150412-PM/ KM SPMT120408-PM/ KM	Milling of steel, alloy steel and cast iron with large cutting depth. Fräsen von Stahl, leg. Stahl und Grauguss. Bei großen Schnitttiefen.	<ul style="list-style-type: none"> • Diameter range Ø40-Ø80 • Coarse and differential pitch, less vibration • Holistic structure with good rigidity, interchangeable heads achieve high economical efficiency. • Durchmesserbereich Ø40-Ø80 • Weite und normale Teilung, weniger Vibrationen • Holistische Struktur mit hoher Stabilität, austauschbare Fräsköpfe für hohe Effizienz und Wirtschaftlichkeit.
	 B167	Kr=90° a _{pmax} =144			
	HMP01 EC  B168	Kr=90° a _{pmax} =144			
Chamfer milling Fasenfräser	CMZ01  B171	Kr=30°	SPMT120408	Chamfer machining of steel, alloy steel, stainless steel and cast iron Fasenfräsen von Stahl, leg. Stahl, rostfreiem Stahl und Gusseisen	<ul style="list-style-type: none"> • Diameter range Ø12, Ø25, Ø32, Ø36 • With the function of milling small surface • Durchmesserbereich Ø12, Ø25, Ø32, Ø36 • Einsatz bei kleinen Flächen
	CMA01  B172	Kr=45°			
	CMD01  B173	Kr=60°			

Milling - Fräsen

General Technical Information - Allgemeine Technische Informationen

B

Milling Tools
Fräser

	Serie Serie	Approach Angle / max. depth of cut Einstellwinkel/ max. Schnitttiefe	Insert WSP	Application Anwendung	Features Merkmale		
Replacingshead milling Wechselkopf-Fräser	QCH-XPHT  B179	Cutting depth: see the detailed information about tool specifications Schnitttiefe: siehe detaillierte Info in der Werkzeug- spezifikation.	XPHT**	Profile milling of steel, stainless steel and cast iron. Formfräsen von Stahl, rostfreiem Stahl und Grauguss.	<ul style="list-style-type: none"> Diameter range Ø16-Ø32 Very suitable for rough machining moulds. Equipped with 3D chipbreaker inserts, high circular edge precision. Tool body with high rigidity. Durchmesserbereich: Ø16-Ø32. Besonders geeignet für das Schruppfräsen von Formen. 3-D Spanbrecher für hohe Rundlaufgenauigkeit Werkzeugkörper mit hoher Stabilität 		
	QCH-SDMT  B182		SDMT**	Face milling and profile milling of steel, alloy steel, stainless steel and cast iron. Plan- und Formfräsen von Stahl, leg. Stahl, rostfreiem Stahl und Grauguss.	<ul style="list-style-type: none"> Diameter range Ø20-Ø40. The cutting forces are decomposed effectively, realize cutting with high feed rate. For plunge milling Double clamping, firm and reliable. Durchmesserbereich Ø20-Ø40. Die Schnittkräfte werden axial konzentriert. Der Fräser ist für hohe Vorschübe geeignet. Tauchfräsen möglich. Doppeltes Klemmsystem für WSP. 		
	QCH-WPGT  B184		WPGT**	Face milling and profile milling of steel, alloy steel, stainless steel and cast iron. Plan- und Formfräsen von Stahl, leg. Stahl, rostfreiem Stahl und Grauguss.	<ul style="list-style-type: none"> Diameter range Ø20-Ø42. The cutting forces are decomposed effectively, realize cutting with high feed rate. Double clamping, firm and reliable. Durchmesserbereich Ø20-Ø42. Die Schnittkräfte werden axial konzentriert. Der Fräser ist für hohe Vorschübe geeignet. Doppeltes Klemmsystem für WSP. 		
	QCH-APKT  B186		APKT**	Multi-function milling of steel, alloy steel, stainless steel, cast iron and Al alloy. Multi-Funktionsfräsen von Stahl, leg. Stahl, rostfr. Stahl und Grauguss.	<ul style="list-style-type: none"> Diameter range Ø16-Ø40 Kr 90° , for square shoulder milling Wiper inserts also suitable for face milling. Inserts with 3D helical cutting edge, less cutting force. Durchmesserbereich: 16 – 40 mm Einstellwinkel 90 Grad zum Eckfräsen Wiper-Schneidplatten zum Planfräsen Schneidplatte im 3-D Design Zirkularschneide zur Reduzierung der Zerspanungskräfte 		
	QCH-RD  B192 B194		RDKW**	Face milling and profile milling of steel, alloy steel, stainless steel and cast iron. Plan- und Formfräsen von Stahl, leg. Stahl, rostfreiem Stahl und Grauguss.	<ul style="list-style-type: none"> Diameter range Ø15-Ø42. R-type inserts possess stronger cutting edge Suitable for machining curved surface of mould Economical milling cutters with screw clamping. Durchmesserbereich: 15 – 42 mm Radiusfräser mit stabiler Schneidkante Einsatz zur Bearbeitung von Formen und Gesenken. Wirtschaftliche Fräser mit Schraubenklammung. 		
	QCH-ZOHX  B196		ZOHX**	Profile milling of steel, stainless steel and cast iron. Formfräsen von Stahl, rostfreiem Stahl und Grauguss.	<ul style="list-style-type: none"> Diameter range Ø16-Ø32 High precision, for finish profile machining. Two types of chipbreaker, used at different machining condition High assembling precision, good stability. Durchmesserbereich: 16-32 mm Hohe Präzision zur Fertigbearbeitung beim Formfräsen. 2 Spanbrechergeometrien für unterschiedliche Anwendungen Hohe Fräserstabilität und Präzision. 		
	Solid carbide extensions Hartmetal-Verlängerungen B198						
	Steel extensions Stahl-Verlängerungen B199						

Overview table for milling Insert - Grades
Fräswendepplatten Übersichtstabelle - Sorten

Workpiece material Workpiece material	ISO	Coatet carbide Beschichtetes Hartmetal		Cermet Cermet	Uncoatet carbide unbeschichtetes Hartmetal	PCBN & PCD PCBN & PKD
		CVD	PVD			
P Steel Stahl	P01		YBG102			
	P10		YBG202 YBG205	YNG151 YNG151C		
	P20	YBC301 YBC302	YBG252 YBG302			
	P30	YBC401 YBM351 YBM253	YB9320		YC30S	
	P40					
M Stainless Steel Rostfreier Stahl	M01		YBG102			
	M10	YBM251 YBM253	YBG202 YBG205	YNG151 YNG151C		
	M20	YBM351 YBC401	YBG252 YBG302			
	M30		YB9320		YC30S	
	M40					
K Cast iron Grauguss	K01		YBG102			
	K10	YBD152	YBG152			
	K20	YBD252	YBG202			YD201
	K30		YBG252			
	K40					
N Non-ferrous materials Ne Metalle	N01				YD051	
	N10		YBG101		YD101	
	N20		YBG202		YD201	
	N30					
S Heat-resistant steel Warmfester Stahl	S01		YBG102			
	S10		YBG202 YBG205			
	S20					
	S30					
H Hardened material Gehärtete Werkstoffe	H01		YBG102			
	H10					
	H20					
	H30					

Coated Cemented Carbide **CVD** Beschichtetes Hartmetall

Grade Sorte	Coating Beschichtung	Micro-Structure Micro-Struktur	ISO	Application Anwendung
YBC301	Substrate with high strength, in combination with MT-Ti(CN), thin layer Al ₂ O ₃ and TiN Coating. Beschichtetes Hartmetall mit hoher Schneidkanten-sicherheit. In Kombination mit TiCN Al ₂ O ₃ , und TiN.		P15~35	Suitable for light and medium milling of low alloy steel and non alloy steel, even under unfavorable condition. Gut geeignet für leichte bis mittlere Fräsbearbeitung von niedriglegierten Stählen unter schwierigen Bedingungen.
YBC302	Substrate with high strength in combination with CVD coating of MT-Ti(CN) and Al ₂ O ₃ in fine grain size and stable structure. Substrat mit hoher Festigkeit in Kombination mit CVD-beschichtete MT-Ti(CN) und Al ₂ O ₃ in feinkörnigem und stabilem Struktur.		P15~35	High performance in milling of alloy steel and casting steel. Fräsen von legiertem Stahl und Gussstahl mit hoher Zerspannleistung.
YBC401	Substrate with excellent toughness, in combination with CVD coating of Ti(CN), thin layer Al ₂ O ₃ , TiN. CVD beschichtetes Hartmetall mit guter Zähigkeit.		P25~50 M20~40	It is suitable for medium to heavy milling steels and stainless steel. Zum Fräsen von Stahl und rostfreiem Stahl in ungünstiger Bearbeitungsbedingung.
YBM251	Substrate with good toughness and strength, in combination with Ti(CN), thin layer Al ₂ O ₃ , TiN. Universal einsetzbare CVD-beschichtete Hartmetallsorte aus TiN +MT-TiCN + dünner Al ₂ O ₃ + TiN mit guter Zähigkeit und Verschleißfestigkeit.		P15~40 M10~30	Good performance in milling of alloy steel and stainless steel. Gute Leistung beim Fräsen von legiertem und rostfreiem Stahl.
YBM253	Carbide substrate with good toughness and strength, in combination with CVD coating of MT-Ti(CN) and Al ₂ O ₃ in fine grain size and stable structure. Hartmetall mit guter Zähigkeit und Festigkeit in Kombination mit CVD beschichtete MT-Ti(CN) und Al ₂ O ₃ in feinkörnigem und stabilem Struktur.		P20~40 M10~30 S10~30	Universal grade for milling of steel, stainless steel and difficult material. Universal einsetzbar Sorte für Fräsen von Stahl, rostfreiem Stahl und schwierige Material.
YBM351	MT-TiCN+Al ₂ O ₃ coated carbide grade with very good strength and impact resistance. Beschichtete Hartmetallsorte MT-TiCN+Al ₂ O ₃ mit ausgezeichneter Widerstandsfähigkeit und Schneidkantensicherheit.		P25~40 M20~40	It is for milling of steel, alloy steel and stainless steel. Zum Fräsen von Stahl, legiertem und rostfreiem Stahl
YBD152	Hard medium grain Substrate in combination with TiCN, thick Al ₂ O ₃ coating. Hartes mittel-feinkörniges Substrat mit TiCN, dicker Al ₂ O ₃ Beschichtung.		K05~25	It is suitable for machining of gray cast iron and nodular cast iron under normal cutting conditions from low to moderate cutting speeds. Bearbeitung von Guss und Kugelgraphitguss mit niedrigen bis mittleren Schnittgeschwindigkeiten.
YBD252	Tough K-substrate in combination with TiN, TiCN, thick Al ₂ O ₃ coating. For milling of cast iron and alloy steel. Zähes K-Substrat mit TiCN, dicke Al ₂ O ₃ Beschichtung.		K15~35	For milling of cast iron and alloy steel. Zum Fräsen von Guss und legiertem Stahl.

B

Milling Tools
Fräser



Coated Cemented Carbide **PVD** Beschichtetes Hartmetall

B

Milling Tools
Fräser

Grade Sorte	Coating Beschichtung	ISO	Application Anwendung
YBG102	PVD nano-TiAlN coated fine grain hard carbide grade. Nano-TiAlN PVD-beschichtete, feinkörnige Hartmetallsorte.	K05~K20	For light milling of cast iron, hard steel. Zum Schlichtfräsen von Guss und gehärtetem Stahl.
YBG202	PVD nano-TiAlN coated fine grain hard carbide grade. Good performance in combination of toughness and wear resistance. Nano-TiAlN PVD-beschichtete, feinkörnige Hartmetallsorte. Hervorragende Kombination von Zähigkeit und Verschleißfestigkeit.	P10~30	Milling of steel, finishing and semi-finishing of stainless steel, and hightemperature alloys . Zum Fräsen von Stahl, rostfreiem Stahl und warmfesten Superlegierungen bei leichter und mittlerer Bearbeitung.
		M10~30	
		S05~20	
YBG320	New coating technology with increased adhesion between coating and substrate and an excellent combination of toughness and hardness. The new grade also has a high temperature resistance. Neue Beschichtungstechnologie mit optimaler Schichthftung und einer guten Kombination aus Zähigkeit und Härte. Die neue Sorte hat auch eine hohe Temperaturbeständigkeit.	P10~30	Suitable for a wide application range in stainless steel and also heat resistance material. Für ein breites Anwendungsspektrum in rostfreien und warmfesten Materialien.
		M10~30	
		S05~20	
YBG205	PVD multilay coated special nano-TiAlxN fine grain hard carbide grade. Good performance in combination of toughness and wear resistance. PVD mehrlagig beschichtete spezielle Nano-TiAlxN, feinkörnige Hartmetallsorte. Hervorragende Kombination von Zähigkeit und Verschleißfestigkeit.	P10~30	Milling of steel, finishing and semi-finishing of stainless steel. Zum Fräsen von Stahl, rostfreiem Stahl bei leichter und mittlere Bearbeitung
		M10~30	
		S05~20	
YBG302	Substrate with reasonable hardness and strength + Nano-TiAlN PVD coating Substrate mit guter Härte und Festigkeit + Nano-TiAlN PVD Beschichtung.	P25~P40	For rough and semi-finish milling of steel and stainless steel. Anwendung für mittlere und Schruppbearbeitung von Stahl, und rostfreiem Stahl.
		M25~40	
YBG152	Substrate with medium hardness and strength + Nano-TiAlN PVD coating Substrate mit mittlerer Härte und Festigkeit + Nano-TiAlN PVD Beschichtung	K 20~35	Applicable for rough and semi-finish milling of cast iron. Anwendung für Schrupp- und mittlere Bearbeitung. von Guss.
YBG252	Ultra fine carbide substrate plus nano-TiAlN PVD coating with high strength, thoughness and wear resistance. Ultra-Feinkorn-Hartmetall plus Nano-TiAlN PVD-Beschichtung mit guter Zähigkeit und Verschleißfestigkeit.	P05~20	Special for finishing of alloy steel, stainless steel and cast iron. Speziell zum Schlichten von legiertem Stahl, rostfreiem Stahl und Guss.
		M05~20	
		K05~K20	

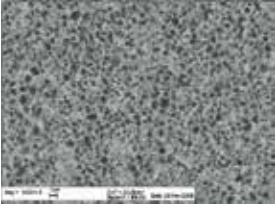
Cermet Cermet

Grade Sorte	Micro-Structure Micro-Struktur	ISO	Application Anwendung
YNG151		P05~20	Applicable for finishing P, M & K ISO Code Anwendung für die Schlichtbearbeitung P,M und K ISO Anwendungsbereich
		M05~20	
		K05~20	
YNG151C		P01~20	Applicable for finish milling P, M and K ISO Code Anwendung für die Schlichtbearbeitung P,M und K ISO Anwendungsbereich
		M01~20	
		K01~20	

B

Milling Tools
Fräser

Application Anwendung



Machine Maschine	Machining center, dry cutting Bearbeitungszentrum, Trockenbearbeitung	Machining center, dry cutting Bearbeitungszentrum, Trockenbearbeitung
Workp. material & hardness Werkstückstoff & Härte	45 steel HB 170~220 Stahl	NAK80* HRC42~48
Type of machining Bearbeitung	Face milling finishing Schlichtfräsen	Face milling finishing Schlichtfräsen
Milling tool Fräs Werkzeug	FMA03-160-B40-SE12-08	FME03-160-B40-SP12-10
Applicable insert Fräsplatte	YNG151/SEEN1203AFTN	YNG151C/SPEN1203EDER
Cutting data Schnittdaten	Vc=400m/min, fz=0.1mm/z, ap=0.3mm	Vc=420m/min, fz=0.12mm/z, ap=0.35mm

Application results Ergebnis

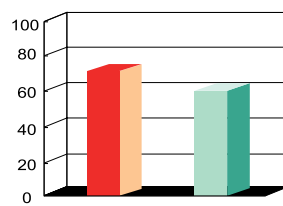

Number of workpiece machined
Anzahl der Werkstücke

■ ZCC-CT ■ Competitor
Wettbewerber

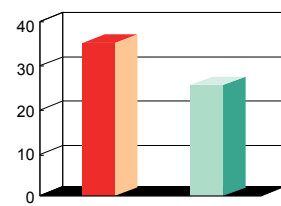

Number of workpiece machined
Anzahl der Werkstücke

■ ZCC-CT ■ Competitor
Wettbewerber

Uncoated Carbide unbeschichtetes Hartmetall

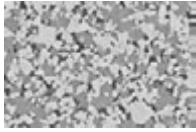
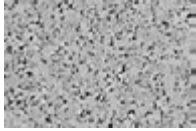
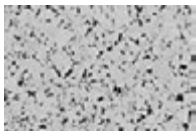
Grade Sorte	Micro-Structure Micro-Struktur	ISO	Application Anwendung
YC30S		P25~40	Applicable for roughing ISO Code P, M
		M25~40	Anwendung für die Schruppbearbeitung ISO Anwendungsbereich P & M.
YD101		N05~25	Applicable for semi-finish and finish milling type ISO Code N. Anwendung für die Mittlere bis Feinbearbeitung ISO Anwendungsbereich N.
YD201		K15~35	Applicable for rough and semi-finish ISO Code K, and for semi-finish ISO Code N.
		N15~30	Anwendung für die mittlere bis Schrupp- Bearbeitung ISO Anwend. K und für die mittlere bearbeitung N ISO Anwendung.

Application Anwendung

Component
Werkstück

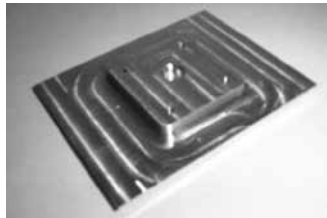

Machine
Maschine

Verti. machining center, wet machining
Vertikales Bearbeitungszentrum, Kühlmittel

Face milling machine, wet machining
Planfräsmaschine, Kühlmittel

Face milling machine, dry cutting
Planfräsmaschine,
Trockenbearbeitung

Workp. material & hardn.
Werkstückstoff & Härte

Aluminum alloy HB100
Aluminum Leg.

40CrMnMo HB240

HT250 HB220

Type of machining
Bearbeitung

Face milling
Planfräser

Face milling
Planfräser

Face milling
Planfräser

Milling tool
Fräswerkzeug

FMA01-100-B32-SE12-07

FMP01-100-B32-TP22-06

FME03-160-B40-SP15-10

Applicable insert
Fräsplatte

YD101/SEET12T3-LH

YC30S/TPKN2204PDR

YD201/SPKN1504EDTR

Cutting data
Schnittdaten

$V_c=300-350\text{m/min}$, $a_p=1-2\text{mm}$,
 $f_z=0.2\text{mm/z}$

$V_c=170\text{m/min}$, $a_p=5-7\text{mm}$,
 $f_z=0.3\text{mm/z}$

$V_c=100-130\text{m/min}$, $a_p=7\text{mm}$,
 $f_z=0.35\text{mm/z}$

Application results
Ergebnis

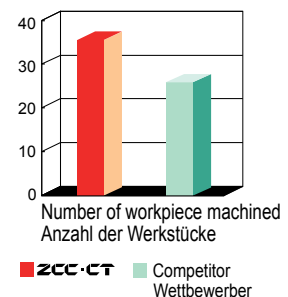
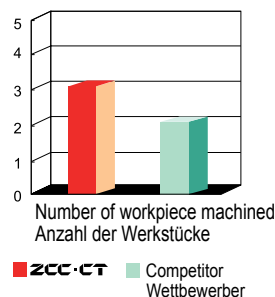
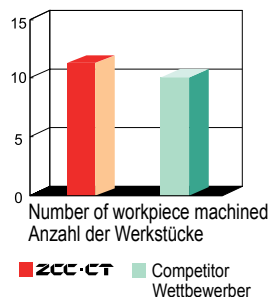



New YBC302







New QCH

Exchangable milling head
Einschraubfräser

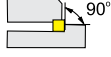
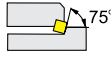
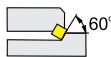

Indexable milling tools code key · Kennzeichnung Fräsen ISO Code

Cutter style Fräser Typ	
FM	Face milling tools Planfräser
EM	Shoulder face milling tools Eck- und Nutenfräser
HM	Helix end milling tools Walzenstirnfräser
SM	Side and face milling tools Scheibenfräser
BM	Profile milling tools Kopierfräser
CM	Chamfering end milling tools Fasfräser
XM	Special milling tools Sonderfräser
TM	

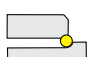
Lead angle Einstellwinkel der Platten		
P	90°	
E	75°	
D	60°	
A	45°	
R		





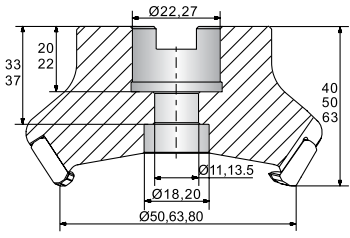
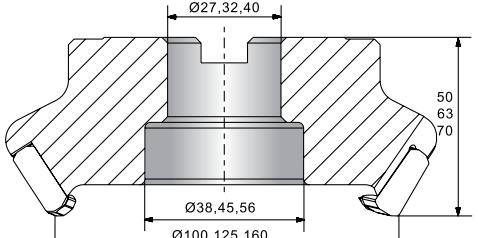
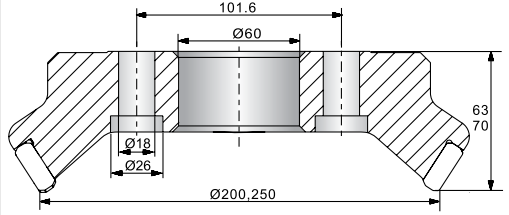
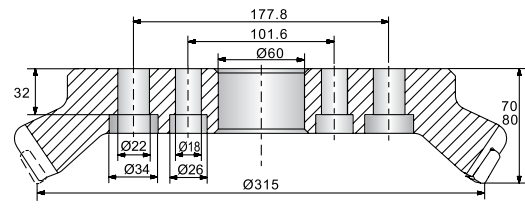



Serial number Serien Nr.
Tool diameter Werkzeug Durchmesser Side and face milling tool : diameter x cutting edge width Plan- und Eckfräser: Durchmesser x WSP-Breite
Coupling size (mm) (as follow figure) Aufnahmetyp

FM E 03 100 - B 32

Structure shape and size of positioning Ausführung und Größe von Werkzeugaufnahme			
A		B	
	Arbor Welle $\varnothing 50\text{-}\varnothing 80$		Arbor Welle $\varnothing 100\text{-}\varnothing 160$
C		D	
	Arbor Welle $\varnothing 200\text{-}\varnothing 250$		Arbor Welle $\varnothing 315$
G	Cylindrical Shank / Zylinderschaft	MW	MW
XP	Weldon / Weldon		

Regarding to the Weldon shank, straight shank and Morse taper shank etc coupling method, please refer to the technical data of tooling systems

Bezüglich der Befestigung beachten Sie bitte die Angabe der Werkzeugaufnahmehersteller.

Insert shape Schneidplattenform	
 C	 D
 R	 S
 T	 L
 H	 O

Insert clearance angle Freiwinkel der Platten	
N	0°
B	5°
C	7°
P	11°
D	15°
E	20°
F	25°

Diameter Durchmesser	Cutting edge length of insert Schneidenlänge					
	Insert Shape Plattenform					
	C	D	R	S	T	L
5.556	—	—	—	—	09	—
6.350	06	07	—	—	11	—
9.525	09	11	09	09	16	—
12.700	12	15	12	12	22	—
15.875	16	19	15	15	27	—
19.050	19	—	19	19	33	—
25.400	25	—	25	25	44	25

S - P 12 - 06 L C

Number of teeth
Anzahl Zähne

Cutting direction
Schnittrichtung
R= right L=left
R= rechts L= links

With Internal cooling
Mit Innenkühlung

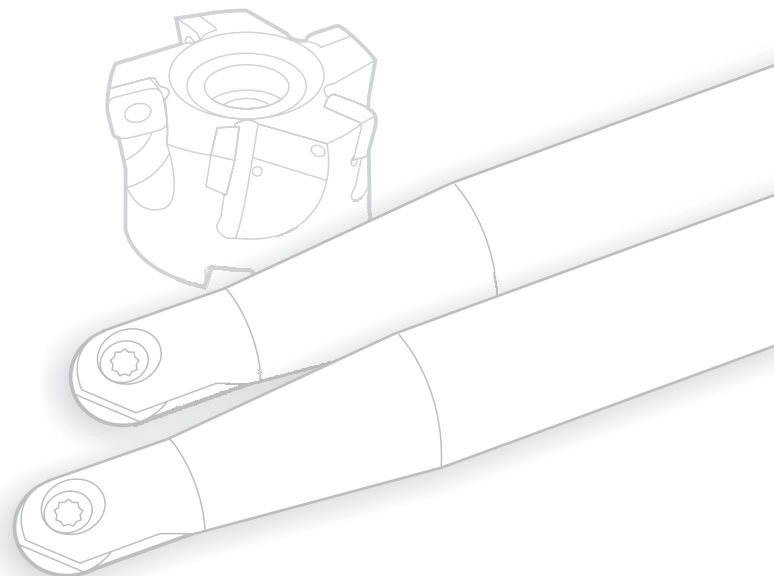
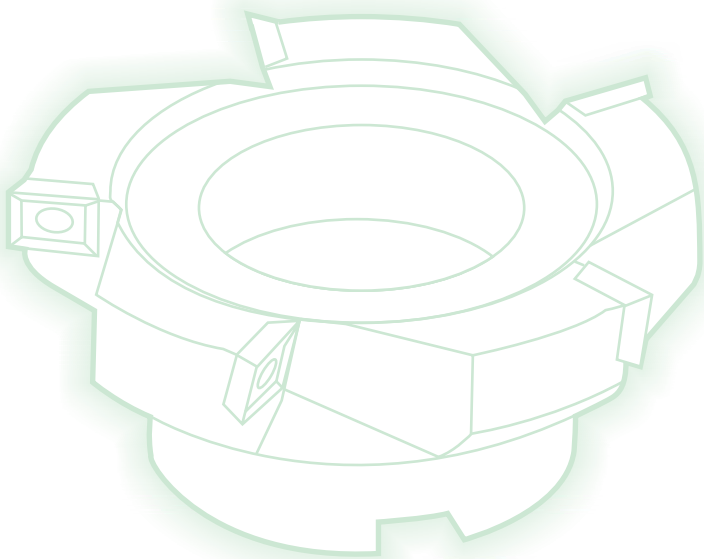

B

Milling Tools
Fräser

Milling · Fräsen

Indexable Milling Tools · Wendepplattenfräser

Face Milling Tools · Planfräser

Kr:45°



FMA01 P M K N S



Fine pitch
Enge Teilung

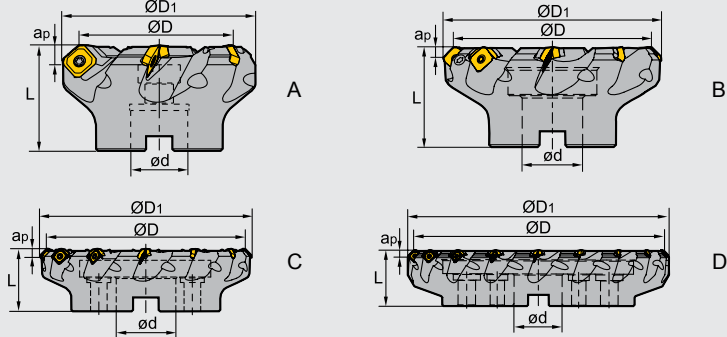

Specification of tools · Werkzeug Beschreibung

Type Typ	Stock Lager	Dimension (mm) Abmessung							No. of teeth Zähne	Coupling Aufnahme	Weight Gewicht (kg)
		R	L	Ø D	Ø D ₁	Ø D	L	ap _{max}			
FMA01 -050-A22-SE12-04	● ○			50	61	22	40	6	4	A	0.3
-050-A22-SE12-04C	● ○	*		50	61	22	40	6	4	A	0.3
-063-A22-SE12-05	● ○			63	74	22	40	6	5	A	0.5
-063-A22-SE12-05C	● ○	*		63	74	22	40	6	5	A	0.5
-063-A22-SE12-05C	○ ○			63	74	22	40	6	6	A	1.2
-080-A27-SE12-06	● ○			80	91	27	50	6	6	A	1.2
-080-A27-SE12-06C	● ●	*		80	91	27	50	6	6	A	1.2
-100-B32-SE12-07	● ○			100	107	32	50	6	7	B	1.2
-100-B32-SE12-07C	● ○	*		100	107	32	50	6	7	B	1.2
-125-B40-SE12-08	● ●			125	136	40	63	6	8	B	2.6
-125-B40-SE12-08C	● ○	*		125	136	40	63	6	8	B	2.6
-160-B40-SE12-10	● ●			160	170	40	63	6	10	B	4.3
-160-B40-SE12-10C	○ ○	*		160	170	40	63	6	10	B	4.3
-200-C60-SE12-12	● ○			200	210	60	63	6	12	C	7.6
-250-C60-SE12-14	● ○			250	260	60	63	6	14	C	13.5
-315-D60-SE12-18	● ○			315	325	60	70	6	18	D	20.8
-100-B32-SE18-04	○ ○			100	120	32	63	10	4	B	1.2
-125-B40-SE18-05	○ ○			125	145	40	63	10	5	B	2.6
-160-C40-SE18-06	○ ○			160	180	40	63	10	6	C	4.3
-200-C60-SE18-08	● ○			200	220	60	63	10	8	C	7.6
-250-C60-SE18-10	● ○			250	270	60	63	10	10	C	13.5
-315-D60-SE18-12	○ ○			315	335	60	80	10	12	D	20.8

Spare Parts · Ersatzteile

Diameter Durchmesser Ø D	Screw Schraube	Shim Unterlage	Shim screw Unterlagenschraube	Wrench Schlüssel	Wrench Schlüssel
SE12 Ø50-Ø100	I60M3.5×10	--	--	WT15IS	--
SE12 Ø125-Ø315	I60M3.5×12	S13BS	SM5×7XA	WT15IS	WH35L
SE18 Ø100-Ø315	I60M5×17	S18BS	vSM8×9XA	WT20IT	WH50L

Coupling Aufnahme	Diameter Durchmesser Ø D	Screw-Schraube	Ring-Dichtring
B32	Ø100	LDB32C	B32-002-CP
B40	Ø125	LDB40C	B40-002-CP
B40	Ø160	LDB40C	B40-003-CP

● Ex Stock / ab Lager ○ On demand / auf Anfrage * With internal cooling · Mit Innenkühlung

Face Milling Tools · Planfräser

Kr:45°



FMA02 P M K N S



Coarse and differential pitch
Normale und weite Teilung

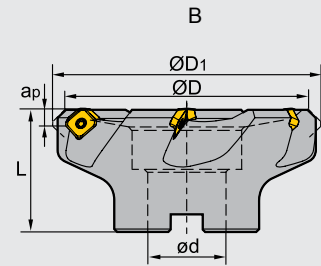
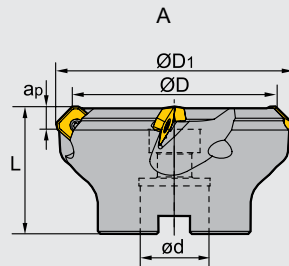

Specification of tools · Werkzeug Beschreibung

Type Typ	*	Stock Lager		Dimension (mm) Abmessung					No. of teeth Zähne	Coupling Aufnahme	Weight Gewicht (kg)
		R	L	Ø D	Ø D ₁	Ø D	L	ap _{max}			
FMA02		●	○	50	61	22	40	6	3	A	0.4
	*	○	○	50	61	22	40	6	3	A	0.4
		●	○	63	74	22	40	6	4	A	0.6
	*	○	○	63	74	22	40	6	4	A	0.6
		●	○	80	91	27	50	6	4	A	1.3
	*	○	○	80	91	27	50	6	4	A	1.3
		●	○	100	107	32	50	6	5	B	1.3
	*	○	○	100	107	32	50	6	5	B	1.3
		○	○	125	131	40	63	6	6	B	2.6
	*	○	○	125	131	40	63	6	6	B	2.6

● Ex Stock / ab Lager ○ On demand / auf Anfrage * With internal cooling · Mit Innenkühlung

Spare Parts · Ersatzteile

Diameter Durchmesser Ø D	Screw Schraube	Wrench Schlüssel
Ø50-Ø125	I60M3.5×10	WT15IS



Coupling Aufnahme	Diameter Durchmesser Ø D	Screw-Schraube	Ring-Dichtring
B32	-	LDB32C	B32-002-CP
B40	Ø125	LDB40C	B40-002-CP

Applicable tool B11-B18
Werkzeug

Tools code key B26-B27
Werkzeug ISO

Grade selection guide B19-B23
Sortenauswahl

Technical data B236-B241
Technische Daten

Milling · Fräsen

Indexable Milling · Fräswendeplatten

Applicable inserts · Wendeschneidplatten

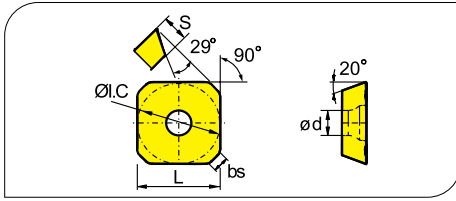

Workpiece Material Werkstoffe	Ideal Machining Condition Gute Bearbeitungsbedingungen			Normal Machining Condition Normale Bearbeitungsbedingungen			Unfavorable Machining Condition Ungünstige Bearbeitungsbedingungen								
	P	M	K	N	S	P	M	K	N	S	P	M	K	N	S
P Steel Stahl	●	●	●	●	●	●	●	●	●	●	●	●	●	●	●
M Stainless Steel Rostfreier Stahl	●	●	●	●	●	●	●	●	●	●	●	●	●	●	●
K Cast iron Gusseisen	●	●	●	●	●	●	●	●	●	●	●	●	●	●	●
N Non-ferrous material Nichte Metalle	●	●	●	●	●	●	●	●	●	●	●	●	●	●	●
S Heat-resistant steel Wärmefester Stahl	●	●	●	●	●	●	●	●	●	●	●	●	●	●	●

B

Milling Tools
Fräser

Insert shape Plattenform	Type Typ	Dimension (mm) Abmessung						CVD Coating CVD Beschicht.						PVD Coating PVD Beschicht.				Cermets Cermet		Carbide uncoat. unbe. Hartmetall									
		L	ØI.C	S	ød	bs	R	YBC302	YBC301	YBC401	YBM255	YBM251	YBM351	YBD152	YBD252	YBG102	YBG320	YBG205	YBG202	YBG212	YBG302	YBG152	YBG252	YNG151	YNG151C	YC30S	YD101	YD201	
	SEET12T3-DF	13.4	13.4	3.97	4.1	2.55	-	●	●			●	●							●	●			●	●				
	SEET12T3-CF	13.4	13.4	3.97	4.1	2.55	-							●		●													
	SEET12T3-EF	13.4	13.4	3.97	4.1	2.55	-													●		●							
	SEET12T3-DM	13.4	13.4	3.97	4.1	2.55	-	●	●	●	●	●	●			●			●		●								
	SEET12T3-CM	13.4	13.4	3.97	4.1	2.55	-							●		●													
	SEET12T3-EM	13.4	13.4	3.97	4.1	2.55	-						●	●					●		●								
	SEET12T3-DR	13.4	13.4	3.97	4.1	2.55	-	●	●				●	●					●		●								
	SEET12T3-CR	13.4	13.4	3.97	4.1	2.55	-							●	●														
	SEET12T3-LH	13.4	13.4	3.97	4.1	2.55	-									●											●	●	
	SEET12T3-W	17.82	13.4	3.97	4.1	9.46	500					○	●					●						●	○				

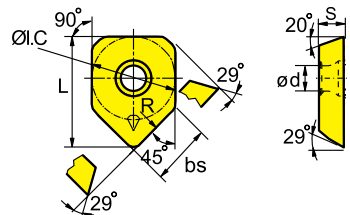

● Ex Stock / ab Lager ○ On demand / auf Anfrage

Chipbreaker Selection for FMA01 · Spanbrecher Auswahl für FMA01

Application Anwendung		Finishing Schlichten	Semi-Finishing Mittlere Bearbeitung	Roughing Schruppen
P		-DF	-DM	-DR
M	S	-EF	-EM	
K		-CF	-CM	-CR
N		-LH		

Recommended cutting data · Empfohlene Schnittdaten

Workpiece material Werkstückstoff	Hardness HB Härte	Grade Sorte	Cutting data Schnittdaten			
			V (m/min)	f (mm/z)		
				-DF	-DM	-DR
P	Low-carbon steel Soft steel Niedrig legierter Kohlenstoffstahl Baustahl	YBM251 YBC301	270(220-350)	0.15(0.1-0.2)	0.2 (0.1-0.3)	0.3(0.2-0.4)
		YBG202 YBG205	270(200-360)	0.15(0.1-0.2)	0.2 (0.1-0.3)	0.3(0.2-0.4)
		YBG302	230(180-350)	0.15(0.1-0.2)	0.2 (0.1-0.3)	0.3(0.2-0.4)
		YBM351 YBC401	220(170-300)	0.15(0.1-0.2)	0.2 (0.1-0.3)	0.3(0.2-0.4)
	High-carbon steel Alloy steel Hoch Leg. Kohlenstoffstahl	YBM251 YBC301	240 (200-320)	0.15(0.1-0.2)	0.2 (0.1-0.3)	0.3(0.2-0.4)
		YBG202 YBG205	240 (180-350)	0.15(0.1-0.2)	0.2 (0.1-0.3)	0.3(0.2-0.4)
		YBG302	220 (150-330)	0.15(0.1-0.2)	0.2 (0.1-0.3)	0.3(0.2-0.4)
		YBM351 YBC401	200 (150-280)	0.15(0.1-0.2)	0.2 (0.1-0.3)	0.3(0.2-0.4)
	Alloy tool steel Leg. Werkzeugstahl	YBM251 YBC301 YBD252	220 (180-300)	0.15(0.1-0.2)	0.2 (0.1-0.3)	0.3(0.2-0.4)
		YBG202 YB9320 YBG205	220 (170-340)	0.15(0.1-0.2)	0.2 (0.1-0.3)	0.3(0.2-0.4)
		YBG302	190 (130-300)	0.15(0.1-0.2)	0.2 (0.1-0.3)	0.3(0.2-0.4)
		YBM351 YBC401	180 (150-250)	0.15(0.1-0.2)	0.2 (0.1-0.3)	0.3(0.2-0.4)
M	Stainless steel Rostfreier Stahl	YBM251	150 (120-240)	0.15(0.1-0.2)	0.2 (0.1-0.3)	
		YBG202 YB9320 YBG205	160 (110-270)	0.15(0.1-0.2)	0.2 (0.1-0.3)	
		YBG302	140 (100-250)	0.15(0.1-0.2)	0.2 (0.1-0.3)	
		YBM351 YBC401	140 (100-220)	0.15(0.1-0.2)	0.2 (0.1-0.3)	
K	Cast iron Gusseisen	YBG102	210 (120-300)	0.15(0.1-0.2)	0.2 (0.1-0.3)	0.3(0.2-0.4)
		YBD152	240 (180-300)	0.15(0.1-0.2)	0.2 (0.1-0.3)	0.3(0.2-0.4)
N	Al alloy NE-Metalle	YD101	300-	-LH 0.25 (0.1-0.4)		
		YD201	300-			
S	High temperature alloy Hoch warmfeste Leg.	YBG202	40(20-50)	-EF	-EM	
				0.1 (0.1-0.2)	0.15 (0.1-0.3)	

Milling · Fräsen

Indexable Milling Tools · Wendeplattenfräser

Case study for FMA 01 Bearbeitungsbeispiel für FMA 01

Workpiece material: 1Cr18Ni9Ti (HB180)
Werkstoff:

Cooling system: dry cutting
Kühlsystem: trocken

Machine: vertical machining center
Maschine: vertikales Maschinen-Center

Cutting data:
Schnittdaten:
Vc=160m/min
ap=1mm
fz=0.2mm/z
ae=60mm

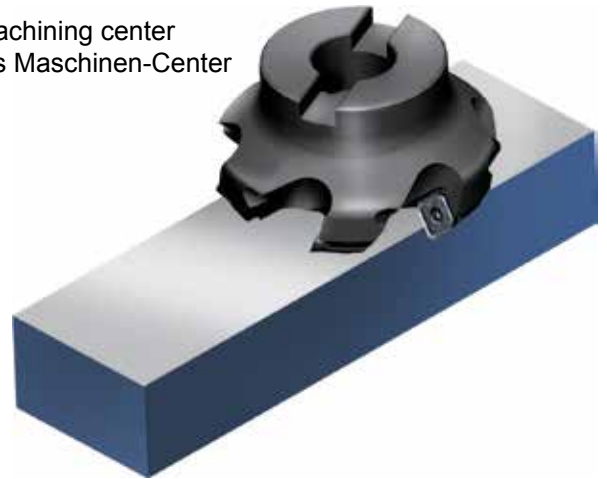

- Tool · Werkzeug : FMR01-080-A27-SE12-06
- Inserts · WSP : SEET12T3-DM/YBG202

Surface roughness of workpiece
Rauhtiefe des Material

ZCC-CT:Ra1.2

Produkt of competitor: Ra1.6
Wettbewerbsprodukt

- Wear comparison of insert.
- Verschleißvergleich der WSP

ZCC-CT

Produkt of competitor
Wettbewerbsprodukt

17'30"



29'30"



33'30"



Face Milling Tools · Planfräser

Kr:45°



FMA03 P M K

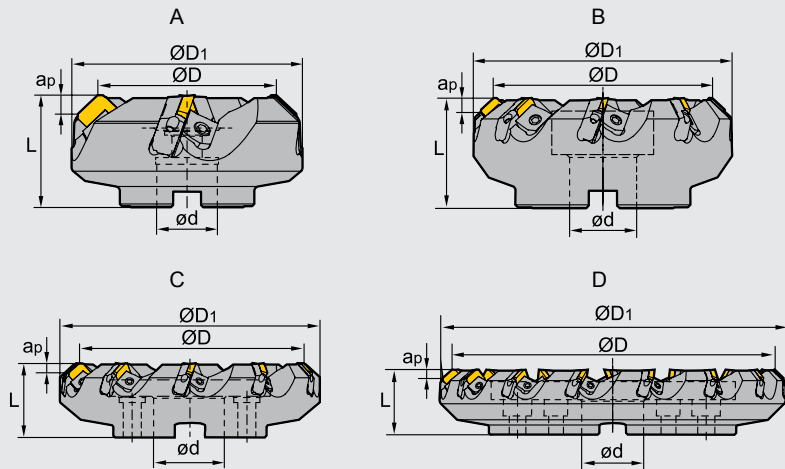

Specification of tools · Werkzeug Beschreibung

Type Typ	Stock Lager	Dimension (mm) Abmessung						No. of teeth Zähne	Coupling Aufnahme	Weight Gewicht (kg)	
		R	L	Ø D	Ø D ₁	Ø d	L				ap _{max}
FMA03											
-080-A27-SE12-04	○ ○			80	103	27	50	5.5	4	A	1.8
-100-B32-SE12-05	○ ○			100	122	32	50	5.5	5	B	2.4
-125-B40-SE12-06	○ ○			125	147	40	63	5.5	6	B	4.4
-160-B40-SE12-08	○ ○			160	181	40	63	5.5	8	B	6.4
-200-C60-SE12-10	○ ○			200	221	60	63	5.5	10	C	8.5
-250-C60-SE12-12	○ ○			250	270	60	63	5.5	12	C	14.1
-315-D60-SE12-15	○ ○			315	353	60	63	5.5	15	D	22.2
-080-A27-SE15-04	○ ○			80	103	27	50	7.5	4	A	1.7
-100-B32-SE15-05	○ ○			100	122	32	50	7.5	5	B	2.3
-125-B40-SE15-06	○ ○			125	147	40	63	7.5	6	B	4.2
-160-B40-SE15-08	○ ○			160	181	40	63	7.5	8	B	6.1
-200-C60-SE15-10	○ ○			200	221	60	63	7.5	10	C	8.3
-250-C60-SE15-12	○ ○			250	270	60	63	7.5	12	C	13.6
-315-D60-SE15-15	○ ○			315	353	60	63	7.5	15	D	21.8

Spare Parts · Ersatzteile

Diameter Durchmesser Ø D	Insert Platte	Cassette Kassette	Wedge Keil	Wedge screw Keilschraube	Locator screw Schraube	Wrench Schlüssel
Ø80-Ø315	SE12	LSE12R/L	W01R/L	DM8×21X	LOM5×15.1	WT20T WH40T
Ø80-Ø315	SE15	LSE15R/L				

● Ex Stock / ab Lager ○ On demand / auf Anfrage

Applicable tool B11-B18
Werkzeug

Tools code key B26-B27
Werkzeug ISO

Grade selection guide B19-B23
Sortenauswahl

Technical data B236-B241
Technische Daten

B

Milling Tools
Fräser

Milling · Fräsen

Indexable Milling · Fräswendelplatten

Applicable inserts · Wendeschneidplatten

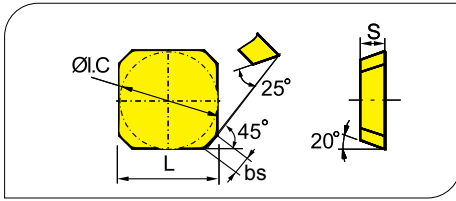

Workpiece Material Werkstoffe	Ideal Machining Condition Gute Bearbeitungsbedingungen			Normal Machining Condition Normale Bearbeitungsbedingungen			Unfavorable Machining Condition Ungünstige Bearbeitungsbedingungen		
	P	M	K	P	M	K	P	M	K
P Steel Stahl	●	●	●	●	●	●	●	●	●
M Stainless Steel Rostfreier Stahl	●	●	●	●	●	●	●	●	●
K Cast iron Gusseisen	●	●	●	●	●	●	●	●	●
N Non-ferrite material Ne Metalle	●	●	●	●	●	●	●	●	●
S Heat-resistant steel Warmfester Stahl	●	●	●	●	●	●	●	●	●

Insert shape Plattenform	Type Typ	Dimension (mm) Abmessung				CVD Coating CVD Beschicht.							PVD Coating PVD Beschicht.					Cermet Cermet	Carbide uncoat. unbe. Hartmetall								
		L	I.C.	S	bs	YBC302	YBC301	YBC401	YBM253	YBM251	YBM351	YBD152	YBD252	YBG102	YB9320	YBG205	YBG202	YBG212	YBG302	YBG152	YBG252	YNG151	YNG151C	YC30S	YD101	YD201	
	SEEN1203AFTN	12.7	12.7	3.18	1.8																	●					
	SEKN1203AFFN	12.7	12.7	3.18	1.8																						
	SEKN1203AFN	12.7	12.7	3.18	1.8	●											●										
	SEKN1203AFTN	12.7	12.7	3.18	1.8	●		●	●														●	●	●	●	
	SEKN1504AFN	15.875	15.875	4.76	1.6	○																				○	○
	SEKN1504AFTN	15.875	15.875	4.76	1.6	●	●		●	●																○	
	SEKR1203AFN	12.7	12.7	3.18	1.8	●											●										
	SEKR1504AFN	15.875	15.875	4.76	1.6	●																				○	

● Ex Stock / ab Lager ○ On demand / auf Anfrage

Recommended cutting data · Empfohlene Schnittdaten

	Workpiece material Werkstückstoff	Hardness HB Härte	Grade Sorte	Cutting data Schnittdaten	
				V (m/min)	f (mm/z)
P	Low-carbon steel Soft steel Niedriglegierter Kohlenstoffstahl Baustahl	≤180	YNG151	430 (340-500)	0.2 (0.1-0.4)
			YBM251 YBC301	270 (220-350)	0.2 (0.1-0.4)
			YBM351	220 (180-300)	0.25 (0.15-0.3)
			YBG202 YBG205	270 (200-360)	0.2 (0.1-0.3)
			YC30S	140 (100-220)	0.27 (0.1-0.4)
	High-carbon steel Alloy steel Hochleg. Kohlenstoffstahl	180-280	YNG151	400 (320-480)	0.2 (0.1-0.4)
			YBM251 YBC301	240 (200-320)	0.2 (0.1-0.4)
			YBM351	200 (160-280)	0.25 (0.15-0.3)
			YBG202 YBG205	240 (180-350)	0.2 (0.1-0.3)
			YC30S	120 (80-200)	0.27 (0.1-0.4)
	Alloy tool steel Leg. Werkzeugstahl	280-350	YNG151	350 (300-450)	0.2 (0.1-0.4)
			YBM251 YBC301	220 (180-300)	0.2 (0.1-0.4)
			YBM351	180 (150-250)	0.25 (0.15-0.3)
			YBG202 YBG205	220 (170-340)	0.2 (0.1-0.3)
			YC30S	100 (60-180)	0.27 (0.1-0.4)
M	Stainless steel Rostfreier Stahl	≤270	YNG151	220 (160-280)	0.2 (0.1-0.4)
			YBM251	130 (100-220)	0.2 (0.1-0.4)
			YBM351	140 (100-240)	0.25 (0.15-0.3)
			YBG202 YBG205	140 (100-250)	0.2 (0.1-0.3)
			YBG102	210 (120-300)	0.2 (0.1-0.3)
K	Cast iron Gusseisen	180-250	YBD252	200 (150-250)	0.2 (0.1-0.4)
			YD201	100 (80-160)	0.25 (0.1-0.4)

Face Milling Tools · Planfräser

Kr:45°



FMA04 P M K N

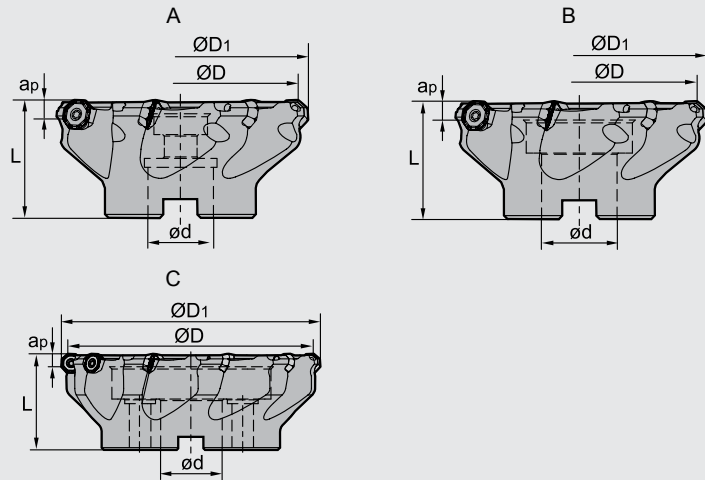

Specification of tools · Werkzeug Beschreibung

Type Typ	*	Stock Lager		Dimension (mm) Abmessung					No. of teeth Zähne	Coupling Aufnahme	Weight Gewicht (kg)
		R	L	Ø D	Ø D1	Ø d	L	apmax			
FMA04		●	○	50	56	22	40	3.5	4	A	0.3
-050-A22-OF05-04C	*	○	○	50	56	22	40	3.5	4	A	0.3
-050-A22-OF05-05		●	○	50	56	22	40	3.5	5	A	0.4
-050-A22-OF05-05C	*	○	○	50	56	22	40	3.5	5	A	0.4
-063-A22-OF05-05		●	○	63	69	22	40	3.5	5	A	0.5
-063-A22-OF05-05C	*	○	○	63	69	22	40	3.5	5	A	0.5
-080-A27-OF05-06		●	○	80	86	27	50	3.5	6	A	0.8
-080-A27-OF05-06C	*	○	○	80	86	27	50	3.5	6	A	0.8
-100-B32-OF05-07		●	○	100	106	32	50	3.5	7	B	1.2
-100-B32-OF05-07C	*	○	○	100	106	32	50	3.5	7	B	1.2
-125-B40-OF05-08		●	○	125	130	40	63	3.5	8	B	2.7
-125-B40-OF05-08C	*	○	○	125	130	40	63	3.5	8	B	2.7
-160-B40-OF05-10		●	○	160	165	40	63	3.5	10	B	5.1

Spare Parts · Ersatzteile

Diameter Durchmesser Ø D	Screw Schraube	Wrench Schlüssel
Ø50- Ø63	I60M4×8.4	WT15IS
Ø80 -Ø160	I60M4×10	

Coupling Aufnahme	Diameter Durchmesser Ø D	Screw-Schraube	Ring-Dichtring
B32	Ø100	LDB32C	B32-002-CP
B40	Ø125	LDB40C	B40-002-CP

● Ex Stock / ab Lager ○ On demand / auf Anfrage * With internal cooling · Mit Innenkühlung

Applicable inserts · Wendschneidplatten

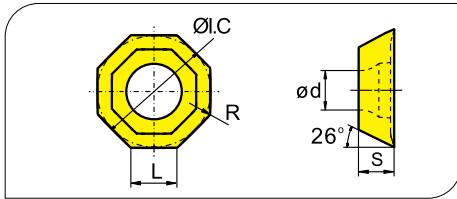

Workpiece Material Werkstoffe	Ideal Machining Condition Gute Bearbeitungsbedingungen			Normal Machining Condition Normale Bearbeitungsbedingungen			Unfavorable Machining Condition Ungünstige Bearbeitungsbedingungen		
	P	M	K	P	M	K	P	M	K
Steel Stahl	●	●	●	●	●	●	●	●	●
Stainless Steel Rostfreier Stahl	●	●	●	●	●	●	●	●	●
Cast iron Gusseisen							●	●	●
Non-ferrous material Nichtmetalle									●
Heat-resistant steel Wärmefester Stahl				●	●	●	●	●	●

Insert shape Plattenform	Type Typ	Dimension (mm) Abmessung					CVD Coating CVD Beschicht.							PVD Coating PVD Beschicht.				Cermets Cermet	Carbide uncoat. unbe. Hartmetall								
		L	I.C	S	d	R	YBC302	YBC301	YBC401	YBM253	YBM251	YBM351	YBD152	YBD252	YBG102	YB9320	YBG205			YBG202	YBG212	YBG302	YBG152	YBG252	YNG151	YNG151C	YC30S
	OFKT05T3-DF	5.26	12.7	3.97	4.4	0.5									●			●									
	OFKT05T3-DM	5.26	12.7	3.97	4.4	0.5					○		●		●			●		●							
	OFKT05T3-LH	5.26	12.7	3.97	4.4	0.5																				●	

Chipbreaker Selection FMA04 · Spanbrecher Auswahl FMA04

Application Anwendung	Finishing Schlichten	Semi-Finishing Mittlere Bearbeitung
P	-DF	-DM
M		
K		
AL	-LH	

Applicable tool
Werkzeug **B11-B18**

Tools code key
Werkzeug ISO **B26-B27**

Grade selection guide
Sortenauswahl **B19-B23**

Technical data
Technische Daten **B236-B241**

Milling · Fräsen

Indexable Milling Tools · Wendeplattenfräser

Recommended cutting data · Empfohlene Schnittdaten

	Workpiece material Werkstückstoff	Hardness HB Härte	Grade Sorte	Cutting data Schnittdaten		
				V (m/min)	f (mm/z)	
					-DF	-DM
P	Low-carbon steel Soft steel Niedriglegierter Kohlenstoffstahl Baustahl	≤180	YBM251	270 (220-350)	0.2 (0.1-0.3)	0.25 (0.1-0.4)
			YBG202 YBG205	270 (200-360)	0.2 (0.1-0.3)	0.25 (0.1-0.4)
			YBM351	220 (180-300)	0.2 (0.1-0.3)	0.25 (0.1-0.4)
			YBG302	230 (170-350)	0.2 (0.1-0.3)	0.25 (0.1-0.4)
	High-carbon steel Alloy steel Hochleg. Kohlenstoffstahl	180-280	YBM251	240 (200-320)	0.15 (0.1-0.3)	0.2 (0.1-0.4)
			YBG202 YBG205	240 (180-350)	0.15 (0.1-0.3)	0.2 (0.1-0.4)
			YBM351	200 (160-280)	0.2 (0.1-0.3)	0.25 (0.1-0.4)
			YBG302	220 (150-330)	0.2 (0.1-0.3)	0.25 (0.1-0.4)
	Alloy tool steel Leg. Werkzeugstahl	280-350	YBM251	220 (180-300)	0.15 (0.1-0.3)	0.2 (0.1-0.4)
			YBG202 YBG205	220 (170-340)	0.15 (0.1-0.3)	0.2 (0.1-0.4)
			YBM351	180 (150-250)	0.2 (0.1-0.3)	0.25 (0.1-0.4)
			YBG302	190 (130-300)	0.2 (0.1-0.3)	0.25 (0.1-0.4)
M	Stainless steel Rostfreier Stahl	≤270	YBG202 YBG205	160 (110-270)	0.15 (0.1-0.3)	0.2 (0.1-0.4)
			YBG302	140 (100-250)	0.15 (0.1-0.3)	0.2 (0.1-0.4)
			YBM251	150 (120-250)	0.15 (0.1-0.3)	0.2 (0.1-0.4)
K	Cast iron Gusseisen	180-250	YBG102	210 (120-300)	0.2 (0.1-0.3)	0.25 (0.1-0.4)
			YBD152	240 (180-300)	0.2 (0.1-0.3)	0.25 (0.1-0.4)
					-LH	
N	Al alloy Leg. Alu	-	YD101	300-	0.15 (0.05-0.3)	

B

Milling Tools
Fräser

Case study for FMA04 Bearbeitungsbeispiel für FMA04



- Tool · Werkzeug : FMA04-100-B32-OF05-07
- Inserts · WSP : OFKT05T3-DM/YBG202

Workpiece material
Werkstückstoff: 42CrMo (HB200)
Cooling system: dry cutting
Kühlsystem: trocken

Machine: vertical machining center
Maschine: vertikales Maschinen-Center

Cutting data
Schnittdaten:
Vc=180m/min
ap=1mm
fz=0.2mm/z
ae=60mm

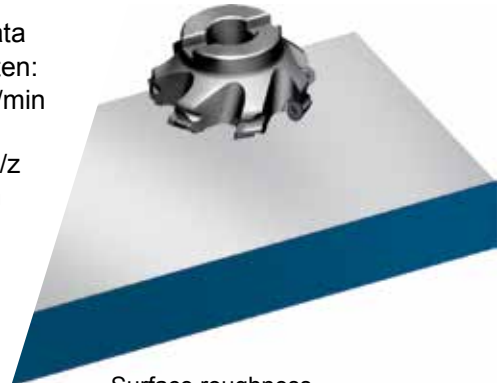

Surface roughness
Rauhtiefe
ZCC-CT: Ra1.2
Wettbewerbsprodukt: **R1.6**

• Wear comparison of insert Verschleißvergleich der WSP

Flank wear VB(mm)
Freiflächenverschleiß

■ Wettbewerb A ■ **ZCC-CT**

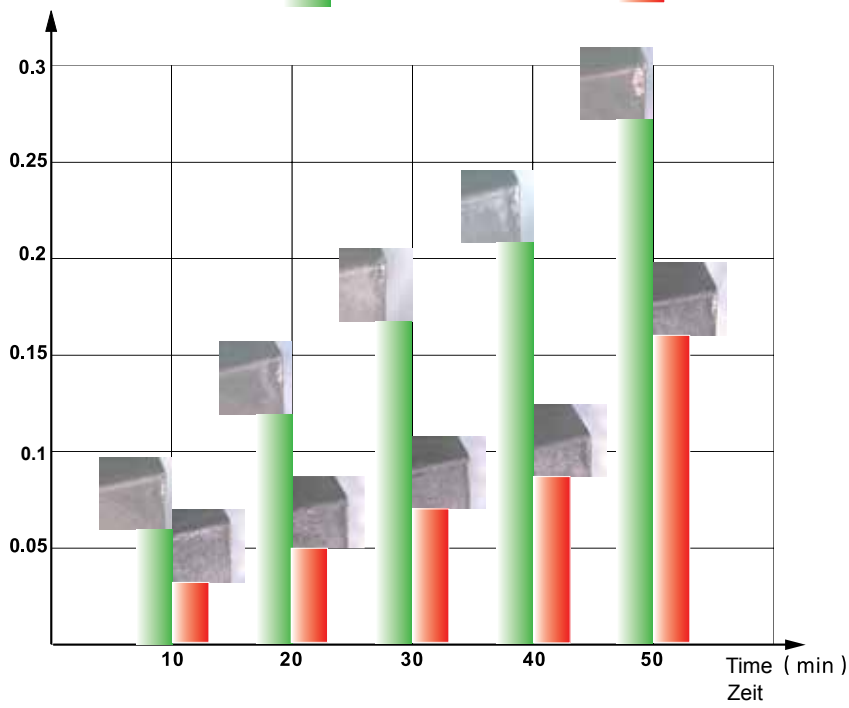

Face Milling Tools · Planfräser

Kr:45°



FMA04 P M K



Wedge
Keil

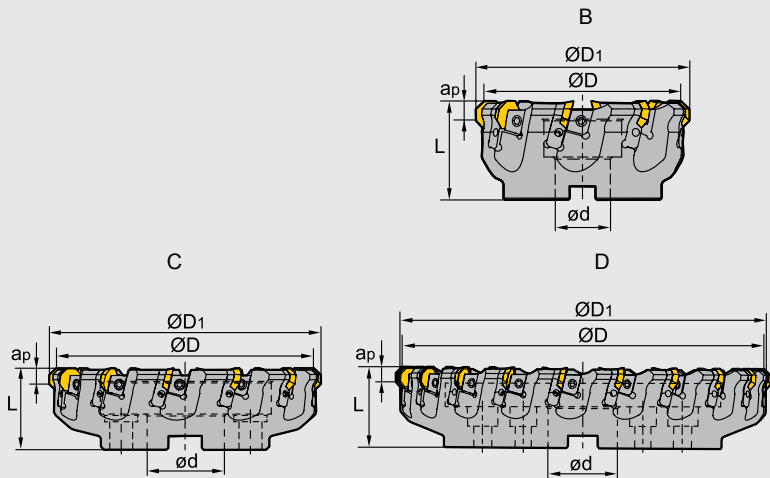

Specification of tools · Werkzeug Beschreibung

Type Typ	Stock Lager	Dimension (mm) Abmessung						No. of teeth Zähne	Coupling Aufnahme	Weight Gewicht (kg)
		R	L	Ø D	Ø D ₁	Ø d	L			
FMA04	-125-B40-OF07-08	●	○	125	136	40	63	5	B	3.9
	-160-B40-OF07-10	●	○	160	171	40	63	5	B	5.9
	-200-C60-OF07-12	●	○	200	211	60	63	5	C	7.6
	-250-C60-OF07-16	●	○	250	261	60	63	5	C	13.3
	-315-D60-OF07-20	●	○	315	321	60	63	5	D	20.3

Spare Parts · Ersatzteile

Diameter Durchmesser Ø D	Cassette Kassette	Wedge Keil	Wedge screw Keilschraube	Locator screw Einstellschraube	Wrench Schlüssel	
Ø125-Ø315	LOF07R/L	W02R/L	DM8×21X	LOM5×15.1	WT20T WH40T	

● Ex Stock / ab Lager ○ On demand / auf Anfrage

Applicable inserts · Wendeschneidplatten

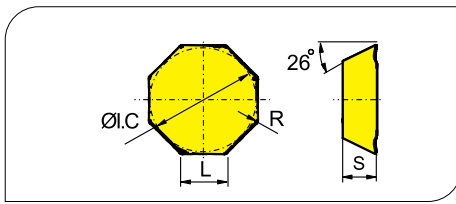

Workpiece Material Werkstoffe	Ideal Machining Condition Gute Bearbeitungsbedingungen			Normal Machining Condition Normale Bearbeitungsbedingungen			Unfavorable Machining Condition Ungünstige Bearbeitungsbedingungen		
	P	M	K	P	M	K	P	M	K
P Steel Stahl	●	●	●	●	●	●	●	●	●
M Stainless Steel Rostfreier Stahl	●	●	●	●	●	●	●	●	●
K Cast iron Gusseisen							●	●	●
N Non-ferrite material Ne Metalle									●
S Heat-resistant steel Wärmfester Stahl				●	●		●	●	

Insert shape Plattenform	Type Typ	Dimension (mm) Abmessung				CVD Coating CVD Beschicht.								PVD Coating PVD Beschicht.				Cermets Cermet		Carbide uncoat. unbe. Hartmetall						
		L	I.C.	S	R	YBC302	YBC301	YBC401	YBM253	YBM251	YBM351	YBD152	YBD252	YBG102	YB9320	YBG205	YBG202	YBG212	YBG302	YBG152	YBG252	YNG151	YNG151C	YC30S	YD101	YD201
	OFKR0704-DF	7.45	17.94	4.76	0.8					○							●									
	OFKR0704-DM	7.45	17.94	4.76	0.8	●	●			●	●		●				○		●							
	OFKR0704W-DM	7.45	17.94	4.76		●						●				●										
	OFKR0704-LH	7.45	19.94	4.76																						○

Chipbreaker Selection FMA04 · Spanbrecher Auswahl FMA04

Application Anwendung	Finishing Schlichten	Semi-Finishing Mittlere Bearbeitung
P		
M	-DF	-DM
K		
N	LH	LH

Applicable tool
Werkzeug **B11-B18**

Tools code key
Werkzeug ISO **B26-B27**

Grade selection guide
Sortenauswahl **B19-B23**

Technical data
Technische Daten **B236-B241**

Milling · Fräsen

Indexable Milling Tools · Wendeplattenfräser

Recommended cutting data · Empfohlene Schnittdaten

Workpiece material Werkstückstoff	Hardness HB Härte	Grade Sorte	Cutting data Schnittdaten			
			V (m/min)	f (mm/z)		
				-DF	-DM	
P Low-carbon steel Soft steel Niedriglegierter Kohlenstoffstahl Baustahl High-carbon steel Alloy steel Hochleg. Kohlenstoffstahl Alloy tool steel Leg. Werkzeugstahl	≤180	YBM251 YBC301	270 (220-350)	0.2 (0.1-0.3)	0.25 (0.1-0.4)	
		YBG202 YBG205	270 (200-360)	0.2 (0.1-0.3)	0.25 (0.1-0.4)	
		YBM351	220 (180-300)	0.2 (0.1-0.3)	0.25 (0.1-0.4)	
		YBG302	230 (170-350)	0.2 (0.1-0.3)	0.25 (0.1-0.4)	
	180-280	YBM251 YBC301	240 (200-320)	0.15 (0.1-0.3)	0.2 (0.1-0.4)	
		YBG202 YBG205	240 (180-350)	0.15 (0.1-0.3)	0.2 (0.1-0.4)	
		YBM351	200 (160-280)	0.2 (0.1-0.3)	0.25 (0.1-0.4)	
		YBG302	220 (150-330)	0.2 (0.1-0.3)	0.25 (0.1-0.4)	
	280-350	YBM251 YBC301 YBD252	220 (180-300)	0.15 (0.1-0.3)	0.2 (0.1-0.4)	
		YBG202 YBG205	220 (170-340)	0.15 (0.1-0.3)	0.2 (0.1-0.4)	
		YBM351	180 (150-250)	0.2 (0.1-0.3)	0.25 (0.1-0.4)	
		YBG302	190 (130-300)	0.2 (0.1-0.3)	0.25 (0.1-0.4)	
M Stainless steel Rostfreier Stahl	≤270	YBG202 YBG205	160 (110-270)	0.15 (0.1-0.3)	0.2 (0.1-0.4)	
		YBG302	140 (100-250)	0.15 (0.1-0.3)	0.2 (0.1-0.4)	
		YBM251	150 (120-250)	0.15 (0.1-0.3)	0.2 (0.1-0.4)	
K Cast iron Gusseisen	180-250	YBG102	210 (120-300)	0.2 (0.1-0.3)	0.25 (0.1-0.4)	
		YBD152	240 (180-300)	0.2 (0.1-0.3)	0.25 (0.1-0.4)	
		YBD252	200 (150-250)	0.2 (0.1-0.3)	0.25 (0.1-0.4)	

B

Milling Tools
Fräser



FMA07

Stable double sided insert with 16 cutting edges for high productivity.

Stabile doppelseitige Wendeschneidplatte mit 16 Schneidecken für hohe Wirtschaftlichkeit.

Positive light cutting chip breaker for finishing to roughing in a wide application field.

Positive, leicht schneidende Spanbrecherform für die Schlicht- bis Schruppbearbeitung mit weitem Anwendungsspektrum.

Cutter body diameter $\varnothing 25$ to $\varnothing 315$, inserts ONHU06** and ONHU08**, grades:

Fräserdurchmesser $\varnothing 25$ bis $\varnothing 315$, WSP ONHU06** und ONHU08**, in den Sorten :

YBC302

CVD
P15 - P35

YBG202

PVD
P10 - P30

YBM253

CVD
P20 - P40

YBM351

CVD
P25 - P40

YBD152

CVD
K05 - K25

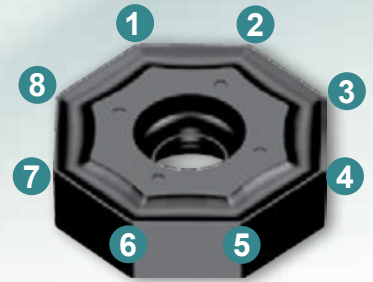

Face milling / Planfräser

Kr:45°



FMA07 **P** **K**

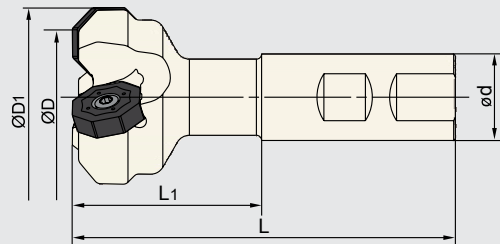



Type Typ	*	Stock Lager		Dimension Abmessung (mm)						Tooth Zähne Z	Weight Gewicht (kg)
		R	L	ØD	ØD ₁	ød	L	L ₁	a _{pmax}		
FMA07 -025-XP20-ON06-02		●	○	25	37	20	95	45	4	2	0.2
-025-XP20-ON06-02C	*	●	○	25	37	20	95	45	4	2	0.2
-032-XP25-ON06-02C	*	●	○	32	44	25	111	55	4	2	0.4
-040-XP25-ON06-03		●	○	40	52	25	106	50	4	3	0.4
-032-XP25-ON08-02		●	○	32	47	25	111	55	5	2	0.4
-032-XP25-ON08-02C	*	●	○	32	47	25	111	55	5	2	0.4
-040-XP25-ON08-03		●	○	40	55	25	111	55	5	3	0.5
-040-XP25-ON08-03C	*	○	○	40	55	25	111	55	5	3	0.5
-050-XP25-ON08-04		●	○	50	65	25	111	55	5	4	0.6

■ Spare Parts · Ersatzteile

● Ex stock / ab Lager ○ On demand / auf Anfrage

* With internal cooling · Mit Innenkühlung

Diameter Durchmesser ØD	Insert WSP	Screw Schraube	Wrench Schlüssel	
				
Ø25 - Ø40	ONHU06** - PF/PM/W	I60M4×10	--	WT15IS
Ø32 - Ø50	ONHU08** - PF/PM/W	I60M5×13	WT20IT	--



Milling · Fräsen

Indexable Milling Tools · Wendepplattenfräser

Face milling / Planfräser

Kr:45°



FMA07 P M K

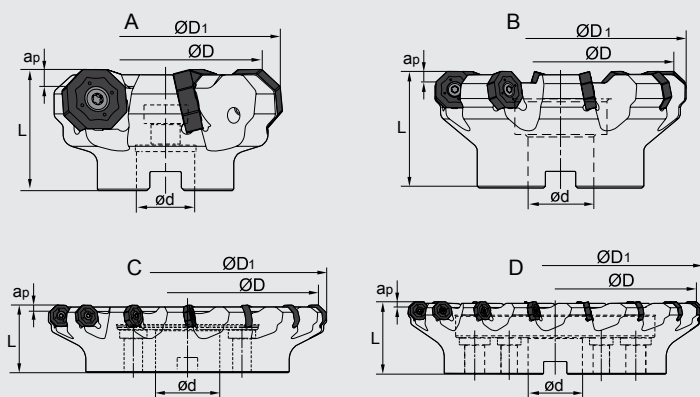

Type Typ	*	Stock Lager		Dimension Abmessung (mm)					Tooth Zähne Z	Coupling Aufnahme	Weight Gewicht (kg)
		R	L	ØD	ØD ₁	ød	L	a _{pmax}			
FMA07		●	○	50	62	22	40	4	5	A	0.3
-050-A22-ON06-05C	*	●	○	50	62	22	40	4	5	A	0.3
-063-A22-ON06-06		●	○	63	75	22	40	4	6	A	0.5
-063-A22-ON06-06C	*	●	○	63	75	22	40	4	6	A	0.5
-080-A27-ON06-07C	*	●	○	80	92	27	50	4	7	A	1.0
-080-B27-ON06-07		●	○	80	92	27	50	4	7	B	1.0
-080-B27-ON06-07C	*	●	○	80	92	27	50	4	7	B	1.0
-100-B32-ON06-08		●	○	100	112	32	63	4	8	B	1.9
-100-B32-ON06-08C	*	●	○	100	112	32	63	4	8	B	1.9
-125-B40-ON06-09		●	○	125	137	40	63	4	9	B	3.5
-125-B40-ON06-09C	*	●	○	125	137	40	63	4	9	B	3.5
-160-C40-ON06-11		●	○	160	172	40	63	4	11	C	4.3
-200-C60-ON06-13		○	○	200	212	60	63	4	13	C	6.4
-250-C60-ON06-15		○	○	250	262	60	63	4	15	C	13.4
-315-D60-ON06-17		○	○	315	327	60	80	4	17	D	21.9
-063-A22-ON08-05		●	○	63	78	22	40	5	5	A	0.5
-063-A22-ON08-05C	*	●	○	63	78	22	40	5	5	A	0.5
-080-A27-ON08-06C	*	○	○	80	95	27	50	5	6	A	0.9
-080-B27-ON08-06		●	○	80	95	27	50	5	6	B	0.9
-080-B27-ON08-06C	*	○	○	80	95	27	50	5	6	B	0.9
-100-B32-ON08-07		●	○	100	115	32	63	5	7	B	1.8
-100-B32-ON08-07C	*	●	○	100	115	32	63	5	8	B	3.1
-125-B40-ON08-08		●	○	125	140	40	63	5	8	B	3.1
-125-B40-ON08-08C	*	●	○	125	140	40	63	5	8	B	3.1
-160-C40-ON08-10		●	○	160	175	40	63	5	10	C	4.1
-200-C60-ON08-12		●	○	200	215	60	63	5	12	C	6.1
-250-C60-ON08-14		●	○	250	265	60	63	5	14	C	12.0
-315-D60-ON08-16		○	○	315	330	60	80	5	16	D	21.0

Spare Parts · Ersatzteile

Diameter Durchmesser ØD	Insert WSP	Screw Schraube		Wrench Schlüssel	
Ø50 - Ø315	ONHU06** - PF/PM/W	I60M4×10		WT15IS	
Ø63 - Ø315	ONHU08** - PF/PM/W	I60M5×13	WT20IT		

Coupling Aufnahme	Diameter Durchmesser Ø D	Screw · Schraube		Ring · Dichtring
B27	Ø80	LDB27C		B27-002-CP
B32	Ø100	LDB32C		B32-002-CP
B40	Ø125	LDB40C		B40-002-CP

● Ex Stock / ab Lager ○ On demand / auf Anfrage * With internal cooling · Mit Innenkühlung

Applicable inserts Wendeschneidplatten

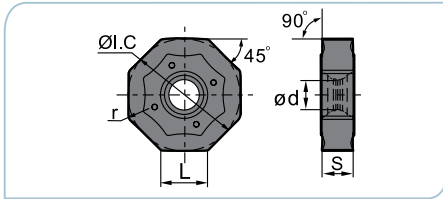

Workpiece Material Werkstoffe	Ideal Machining Condition Gute Bearbeitungsbedingungen			Normal Machining Condition Normale Bearbeitungsbedingungen			Unfavorable Machining Condition Ungünstige Bearbeitungsbedingungen		
	P	M	K	N	S				
P Steel Stahl	●	●	●	●	●	●	●	●	●
M Stainless Steel Rostfreier Stahl	●	●	●	●	●	●	●	●	●
K Cast iron Gusseisen						●	●	●	●
N Non-ferrous material Nichte Metalle									●
S Heat-resistant steel Wärmefester Stahl						●	●	●	●

Insert WSP	Type Typ	Dimension Abmessung (mm)					CVD Coating CVD Beschicht.					PVD Coating PVD Beschicht.				Cermet Cermet	Carbide uncoat. unb. Hartmetall										
		L	Ø1.C	S	ød	r	YBC302	YBC301	YBC401	YBM253	YBM251	YBM351	YBD152	YBD252	YBG102		YBG320	YBG205	YBG202	YBG212	YBG302	YBG152	YBG252	YNG151	YNG151C	YC305	YD101
	ONHU060408-PF	6.58	15.875	4.76	4.4	0.83	●																				
	ONHU08T508-PF	8.39	20.2	5.79	5.3	0.83	●											●									
	ONHU060408-PM	6.58	15.875	4.76	4.4	0.83	●											○									
	ONHU08T508-PM	8.39	20.2	5.79	5.3	0.83	●																				
	ONHU08T508-W	6.9	20.5	6.00	5.3	0.80												○									

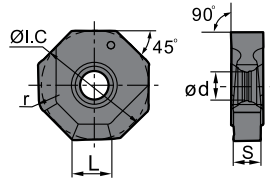

Cutting Data / Schnittdaten

● Ex Stock / ab Lager ○ On demand / auf Anfrage

Workpiece material Werkstück Material	Hardness HB Härte	Grade Sorte	Cutting data · Schnittdaten			
			V _c (m/min)	f _z (mm/z)	a _p (mm)	
					ONHU06**-PM	ONHU08**-PM
P Low-carbon steel Soft steel Niedriglegierter Kohlenstoffstahl Baustahl	≤180	YBC302	270 (220-350)	0.2 (0.1-0.4)	4	5
		YBG202				
		YBM253				
		YBM351				
		YBM253				
		YBM351				
M High-carbon steel Alloy steel Hochleg. Kohlenstoffstahl Leg. Stahl	180-280	YBC302	240 (200-320)	0.2 (0.1-0.4)	4	5
		YBG202				
		YBM253				
		YBM351				
K Alloy tool steel Leg. Werkzeugstahl	280-350	YBM253	240 (180-300)	0.2 (0.1-0.4)	4	5
		YBM351				
M Stainless steel Rostfreier Stahl	≤270	YBM253	230(180-300)	0.2(0.1-0.3)	4	5
		YBM253				
K Cast iron Gusseisen	180-250	YBD152	270 (150-300)	0.4 (0.1-0.5)	4	5

For Example / Beispiele

Wear comparison of insert Verschleißvergleich der WSP

Milling Tools / Fräser: FMA07-100-B32-ON08-07
 Insert / WSP: ONHU08T508-PM YBD152
 Parts / Teile: Case of gear pump / Pumpengehäuse

Workpiece material /
 Werkstückstoff: HT400
 Cooling system / Kühlsystem: dry cutting / trocken

Machine / Maschine: CNC floor Type / CNC Maschine

Cutting data / Schnittdaten: V_c=267m/min f_z=0.42mm/z
 a_p=1.5mm a_e=80mm

Direction / Richtung: Climb milling / Gleichlaufräsen
 Processing site /
 Bearbeitungsebene: End face / Planfläche



Applicable tool
Werkzeug **B11-B18**

Tools code key
Werkzeug ISO **B26-B27**

Grade selection guide
Sortenauswahl **B19-B23**

Technical data
Technische Daten **B236-B241**

FMA 11 *Kr:45°*

New generation of face milling with double sided inserts
Neue Planfräsergeneration mit doppelseitiger WSP



Double sided inserts
 Doppelseitige WSP

8 cutting edges

8 Schneidkanten für wirtschaftliche Auslastung der WSP.

Inserts with large rake angle, reducing power consumption.

Großer Spanwinkel für weichen Schnitt.

Milling cutter with thicker inserts for high stability and deeper cutting depth.

Doppelseitige, extra dicke Wendeschneidplatte für große Spantiefen bei hoher Bruchsicherheit.

Insert grades:
 WSP Sorten:

YBC302

CVD
 P15 - P35

YBM253

CVD
 P20 - P40

YBD152

CVD
 K05 - K25

Maximum cutting depth:
 Maximale Schnitttiefe:



Inserts with wiper cutting edge for good surface quality.

Wiper Geometrie für beste Oberflächengüte.

Comparison of wear

Vergleich

Workpiece Material: GG30 Grey cast iron
 Werkstück Material: Grauguss

Machining: Face milling
 Bearbeitung: Planfräsen

Tool / Werkzeug: FMA11-125-B40-SN12-08

Inserts / WSP: SNEG1205ANR-GM/YBD152

Cutting data: $V_c=300\text{m/min}$ $f_z=0.3\text{ mm/z}$
 Schnittdaten: $a_p=3\text{mm}$ $a_e=80\text{mm}$

	Major cutting edge Hauptschneidkante	Minor Cutting edge Nebenschneidkante	Wiper
FMA11 After 3 Workpieces of machining Nach 3 bearbeiteten Werkstücken			
Competitor / Wettbewerb After 2 Workpieces of machining Nach 3 Bearbeiteten Werkstücken			

Face Milling Tools · Planfräser

Kr:45°

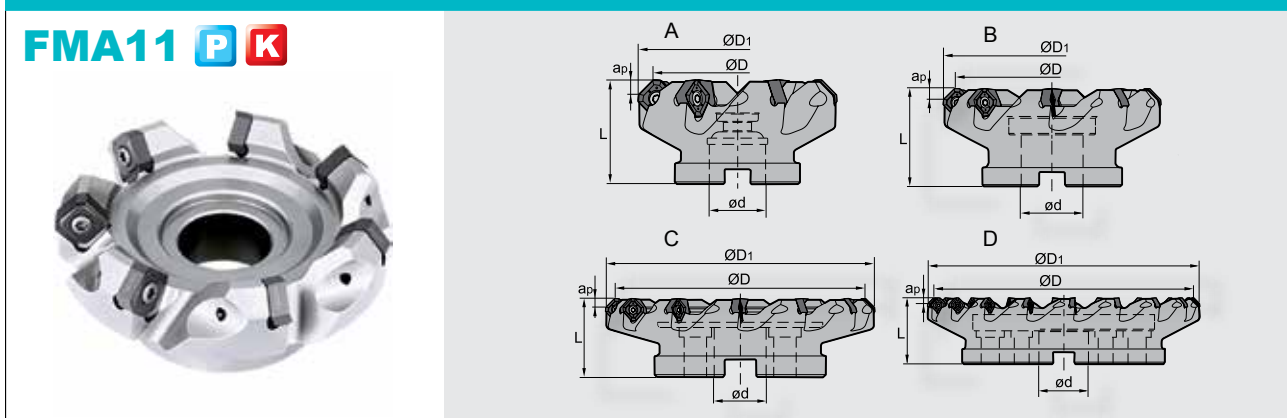

Specification of tools · Werkzeug Beschreibung

Type Typ	Stock Lager	Dimension (mm) Abmessung						No. of teeth Zähne	Coupling Aufnahme	Weight Gewicht (kg)	
		R	L	ØD	ØD1	Ød	L				apmax
FMA11	-063-A22-SN12-05	•		63	74.47	22	40	5.5	5	A	0.55
	-063-A22-SN12-06	•		63	74.47	22	40	5.5	6	A	0.58
	-080-A22-SN12-08	○		80	74.47	22	40	5.5	6	A	1.10
	-080-A27-SN12-06	•		80	91.47	27	50	5.5	6	A	1.14
	-100-B32-SN12-07	•		100	111.47	32	50	5.5	7	B	1.42
	-100-B32-SN12-07C	•*		100	111.47	32	50	5.5	7	B	1.42
	-100-B32-SN12-10C	•		100	111.47	32	50	5.5	10	B	1.42
	-125-B40-SN12-08	•		125	136.47	40	63	5.5	8	B	2.86
	-125-B40-SN12-08C	•*		125	136.47	40	63	5.5	8	B	2.86
	-125-B40-SN12-12C	•*		125	136.47	40	63	5.5	12	B	2.86
	-160-C40-SN12-10	•		160	171.47	40	63	5.5	10	C	4.06
	-160-C40-SN12-15	•		160	171.47	40	63	5.5	15	C	4.06
	-200-C60-SN12-14	•		200	212.08	60	63	5.5	14	C	6.89
FMA11	-063-A22-SN15-05	•		63	77.4	22	40	7.0	5	A	0.56
	-080-A27-SN15-06	•		80	94.4	27	50	7.0	6	A	1.06
	-100-B32-SN15-07	•		100	114.4	32	50	7.0	7	B	1.47
	-100-B32-SN15-07C	•*		100	114.4	32	50	7.0	7	B	1.47
	-100-B32-SN15-09C	•*		100	114.4	32	50	7.0	9	B	1.47
	-125-B40-SN15-08	•		125	139.4	40	63	7.0	8	B	2.70
	-125-B40-SN15-08C	•*		125	139.4	40	63	7.0	8	B	2.70
	-125-B40-SN15-10C	•*		125	140.25	40	63	7.0	10	B	3.10
	-160-C40-SN15-10	•		160	174.4	40	63	7.0	10	C	3.92
	-160-C40-SN15-13	•		160	175.25	40	63	7.0	13	C	4.14
	-200-C60-SN15-12	•		200	214.4	60	63	7.0	12	C	5.46
-250-C60-SN15-14	•		250	264.4	60	63	7.0	14	C	11.26	
-315-D60-SN15-18	○		315	329.4	60	80	7.0	18	D	20.00	
FMA11	-125-B40-SN19-07	•		125	142.63	40	63	9.0	7	B	3.00
	-125-B40-SN19-07C	•*		125	142.63	40	63	9.0	7	B	3.00
	-160-C40-SN19-09	•		160	167.63	40	63	9.0	9	C	4.25
	-200-C60-SN19-11	•		200	217.63	60	63	9.0	11	C	6.18
	-250-C60-SN19-13	•		250	267.63	60	63	9.0	13	C	11.55
	-315-D60-SN19-16	○		315	332.63	60	80	9.0	16	D	20.90

• Ex stock / ab Lager ○ On demand / auf Anfrage * With internal cooling · Mit Innenkühlung

Applicable tool
Werkzeug **B11-B18**

Tools code key
Werkzeug ISO **B26-B27**





Grade selection guide
Sortenauswahl **B19-B23**

Technical data
Technische Daten **B236-B241**



Milling - Fräsen

Indexable Milling Tools - Wendepplattenfräser

Spare Parts - Ersatzteile

Diameter Durchmesser Ø D	Cassette Kassette	Locator screw Keilschraube	Wrench Schlüssel	
				
SN12 Ø63 - Ø200	SNEG1205ANR-GR	I60M3.5x10	--	WT15IS
SN15 Ø63 - Ø315	SNEG1506ANR-GR	I60M5x13	WT20IT	--
SN19 Ø125 - Ø315	SNEG1907ANR-GR	I43M6x16	WT25IT	--



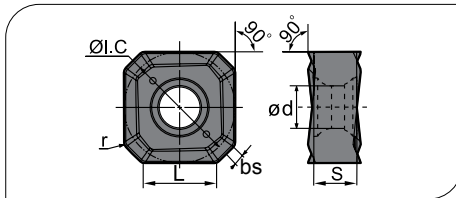

Coupling Aufnahme	Diameter Durchmesser Ø D	Screw-Schraube	Ring-Dichtring
			
B32	Ø100	LDB32C	B32-002-CP
B40	Ø125	LDB40C	B40-002-CP

Applicable inserts - Wendeschneidplatten



Workpiece Material Werkstoffe	Ideal Machining Condition Gute Bearbeitungsbedingungen			Normal Machining Condition Normale Bearbeitungsbedingungen			Unfavorable Machining Condition Ungünstige Bearbeitungsbedingungen			
	P	M	K	N	S	P	M	K	N	S
P Steel Stahl	●	●	●	●	●	●	●	●	●	●
M Stainless Steel Rostfreier Stahl	●	●	●	●	●	●	●	●	●	●
K Cast iron Gusseisen	●	●	●	●	●	●	●	●	●	●
N Non-ferrous material Ne Metalle	●	●	●	●	●	●	●	●	●	●
S Heat-resistant steel Warmfester Stahl	●	●	●	●	●	●	●	●	●	●

Insert shape Plattenform	Type Typ	Dimension (mm) Abmessung						CVD Coating CVD Beschicht.						PVD Coating PVD Beschicht.						Cermet Cermet	Carbide uncoat. unbe. Hartmetall							
		L	I.C	S	bs	Ø d	r	YBC302	YBC301	YBC401	YBM253	YBM251	YBM351	YBD152	YBD252	YBG102	YB9320	YBG205	YBG202			YBG212	YBG302	YBG152	YBG252	YNG151	YNG151C	YC30S
	SNEG1205ANR-GM	7.6	12.0	4.76	1.05	4.6	0.8	●			●		●			●												
	SNEG1506ANR-GM	9.4	15.0	5.54	1.30	5.5	0.9	●		●			●															
	SNEG1205ANR-GR	7.6	12.0	4.76	1.05	4.6	0.8	●		●			●															
	SNEG1506ANR-GR	9.4	15.0	5.54	1.30	5.5	0.9	●		●			●															
	SNEG1907ANR-GR	12.1	19.0	7.0	1.67	7.2	1.0	●		●			●	●														
	SNEG1506ANR-E	9.4	15.0	5.6	1.30	5.5	0.9										●											

● Ex Stock / ab Lager ○ On demand / auf Anfrage

Applicable inserts · Wendeschneidplatten

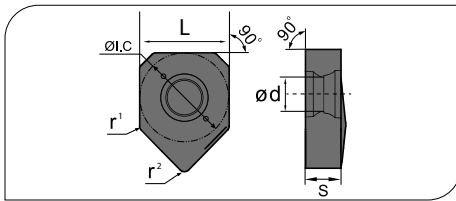

Workpiece Material Werkstoffe	Ideal Machining Condition Gute Bearbeitungsbedingungen			Normal Machining Condition Normale Bearbeitungsbedingungen			Unfavorable Machining Condition Ungünstige Bearbeitungsbedingungen		
	P	M	K	P	M	K	P	M	K
P Steel Stahl	●	●	●	●	●	●	●	●	●
M Stainless Steel Rostfreier Stahl	●	●	●	●	●	●	●	●	●
K Cast iron Gusseisen	●	●	●	●	●	●	●	●	●
N Non-ferrous material Nichtmetalle	●	●	●	●	●	●	●	●	●
S Heat-resistant steel Wärmefester Stahl	●	●	●	●	●	●	●	●	●

Insert shape Plattenform	Type Typ	Dimension (mm) Abmessung						CVD Coating CVD Beschicht.						PVD Coating PVD Beschicht.						Cermets Cermet	Carbide uncoat. unbe. Hartmetall								
		L	I.C.	S	r ¹	Ø d	r ²	YBC302	YBC301	YBC401	YBM253	YBM251	YBM351	YBD152	YBD252	YBG102	YB9320	YBG205	YBG202			YBG212	YBG302	YBG152	YBG252	YNG151	YNG151C	YC30S	YD101
	SNEG1205ANR-W	12	12	4.76	0.6	4.6	0.8											●											

Recommended cutting data · Empfohlene Schnittdaten

Workpiece material Werkstückstoff	Hardness HB Härte	Grade Sorte	Cutting data Schnittdaten		
			V (m/min)	f (mm/z)	a _{pmax}
P Low-carbon steel Soft steel Niedriglegierter Kohlenstoffstahl Baustahl	≤180	YBM253	270 (220-350)	0.2 (0.1-0.4)	5.5-9.0
		YBC302	270 (220-350)	0.2 (0.1-0.4)	5.5-9.0
	180-280	YBM253	260 (200-320)	0.2 (0.1-0.4)	5.5-9.0
		YBC302	260 (200-320)	0.2 (0.1-0.4)	5.5-9.0
	280-350	YBM253	240 (180-300)	0.2 (0.1-0.4)	5.5-9.0
		YBC302	240 (180-300)	0.2 (0.1-0.4)	5.5-9.0
M Stainless steel Rostfreier Stahl	≤270	YBG205	180 (110-260)	0.2 (0.1-0.4)	5.5-9.0
K Cast iron Gusseisen	180-250	YBD152	270 (150-300)	0.4 (0.1-0.5)	5.5-9.0

Applicable tool
Werkzeug **B11-B18**

Tools code key
Werkzeug ISO **B26-B27**

Grade selection guide
Sortenauswahl **B19-B23**

Technical data
Technische Daten **B236-B241**

FMA12 ^{Kr:45°}

High Performance Face Mill with 16 edges for outstanding economy

Hochleistungs-Planfräser mit 16 Schneidkanten für hervorragende Wirtschaftlichkeit



Unique 3-dimensional edge

Einzigartige, dreidimensionale Schneidkante



Maximum cutting depth:
Maximale Schnitttiefe:

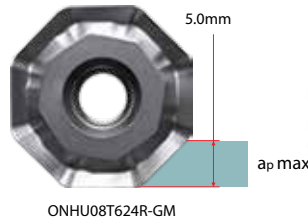

Economic
Wirtschaftlichkeit:



Double negative rake angle, in combination with helical insert structure, achieves double positive axial angle, which will help reduce cutting resistance and improve chip evacuation.

Doppelt negative Spanwinkel in Kombination mit einer spiralförmigen Struktur führen zu doppelt positiven Achswinkeln, die zu einer Reduzierung des Schneidwiderstandes führen und die Spanabfuhr verbessern.

Smooth cut due to positive and sharp cutting edge.

Weicher Schnitt durch positive und scharfe Schneidkantenausführung.

Comparing of wear

Vergleich

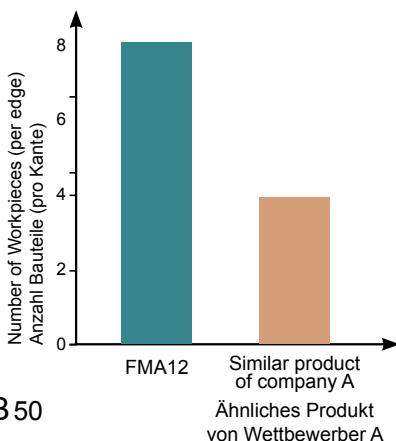

Example

Beispiel



Workpiece: Cylinder
Werkstück: Zylinder

Workpiece Material: HB250 Gray cast iron
Werkstück Material: Grauguss

Machining: Face milling
Bearbeitung: Planfräsen

Tool / Werkzeug: FMA12-160-C40-ON08-10

Inserts / WSP: ONHU08T624R-GM/YBD152

Cutting data: $V_c=150\text{m/min}$ $f_z=0.25\text{ mm/z}$
Schnittdaten: $a_p=3\text{mm}$ $a_e=160\text{mm}$

Cooling: External
Kühlung: Außen

Insert grades:
WSP Sorten:

YBM253

CVD
P20 - P40
M10 - M30

YBG205

PVD
P10 - P30
M10 - M30

YBD152

CVD
K05 - K25

Face Milling Tools · Planfräser

Kr:45°

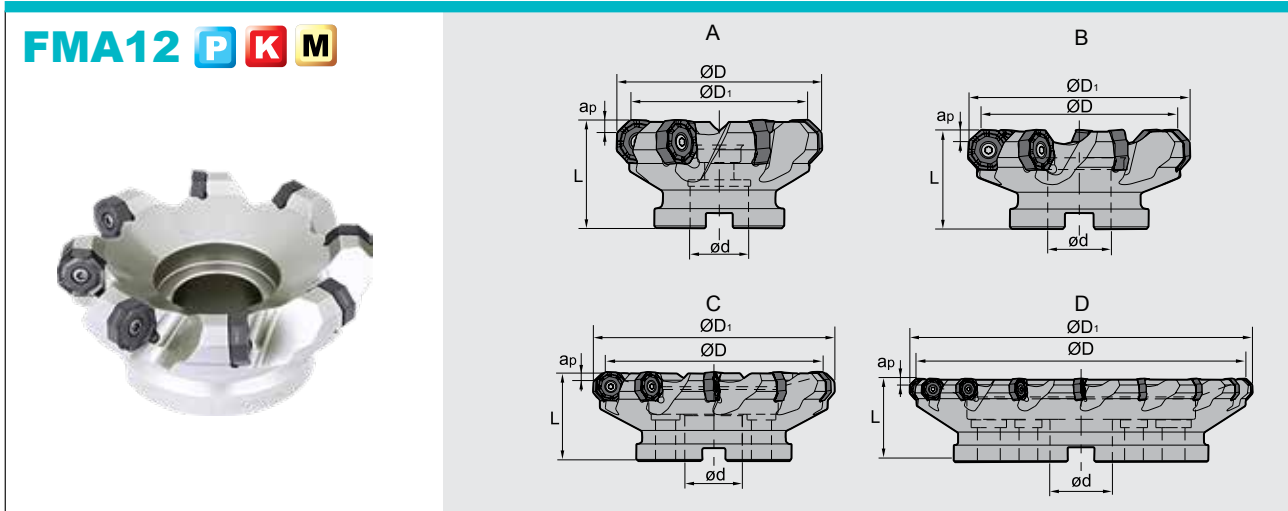





Specification of tools · Werkzeug Beschreibung



Type Typ	*	Stock Lager		Dimension (mm) Abmessung					No. of teeth Zähne	Coupling Aufnahme	Weight Gewicht (kg)
		R	L	ØD	ØD ₁	Ød	L	a _{pmax}			
FMA12	-063-A22-ON08-05	●		63	78	22	50	5.0	5	A	0,6
	-080-A27-ON08-06	●		80	95	27	50	5.0	6	A	0,97
	-100-B32-ON08-07	●		100	115	32	50	5.0	7	B	1,28
	-100-B32-ON08-07C	* ●		100	115	32	50	5.0	7	B	1,28
	-125-B40-ON08-08	●		125	140	40	63	5.0	8	B	2,59
	-125-B40-ON08-08C	* ●		125	140	40	63	5.0	8	B	2,59
	-160-C40-ON08-10	●		160	175	40	63	5.0	10	C	4,10
	-200-C60-ON08-12	○		200	215	60	63	5.0	12	C	5,68
	-250-C60-ON08-14	○		250	265	60	63	5.0	14	C	11,90
	-315-D60-ON08-18	○		315	330	60	80	5.0	18	D	20,41

● Ex stock / ab Lager ○ On demand / auf Anfrage * With internal cooling · Mit Innenkühlung

Spare Parts · Ersatzteile

Diameter Durchmesser Ø D	Insert WSP	Screw Schraube	Drehmoment Torque	Wrench Schlüssel	
Ø80-Ø315	 ONHU08T624R-GM	 I60M5X13	5 Nm	 WT20IT	

We recommend to use torque wrenches · Wir empfehlen den Einsatz von Drehmomentschlüsseln

Coupling Aufnahme	Diameter Durchmesser Ø D	Screw · Schraube	Ring · Dichtring
			
B32	Ø100	LDB32C	B32-002-CP
B40	Ø125	LDB40C	B40-002-CP

Applicable tool **B11-B18**
Werkzeug

Tools code key **B26-B27**
Werkzeug ISO

Grade selection guide **B19-B23**
Sortenauswahl

Technical data **B236-B241**
Technische Daten

Milling · Fräsen

Indexable Milling Tools · Wendepplattenfräser

Applicable inserts · Wendeschneidplatten

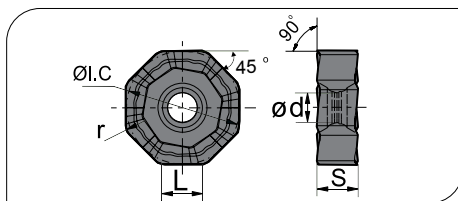

Workpiece Material Werkstoff	Ideal Machining Condition Gute Bearbeitungsbedingungen			Normal Machining Condition Normale Bearbeitungsbedingungen			Unfavorable Machining Condition Ungünstige Bearbeitungsbedingungen		
	P	M	K	P	M	K	P	M	K
P Steel Stahl	●	●	●	●	●	●	●	●	●
M Stainless Steel Rostfreier Stahl	●	●	●	●	●	●	●	●	●
K Cast iron Gusseisen	●	●	●	●	●	●	●	●	●
N Non-ferrous material Nichte Metalle									
S Heat-resistant steel Warmfester Stahl				●	●	●	●	●	●

Insert shape Plattenform	Type Typ	Dimension (mm) Abmessung						CVD Coating CVD Beschicht.				PVD Coating PVD Beschicht.				Cermet Cermet	Carbide uncoat. unbe. Hartmetall															
		L	I.C	S	bs	Ø d	r	YBC302	YBC301	YBC401	YBM253	YBM251	YBM351	YBD152	YBD252		YBG102	YB9320	YBG205	YBG202	YBG212	YBG302	YBG152	YBG252	YNG151	YNG151C	YC30S	YD101	YD201			
	ONHU08T624R-GM	6.38	20.2	6.3	5.3	2.4	0.8				●							●														

Recommended cutting data · Empfohlene Schnittdaten

Workpiece material Werkstückstoff	Hardness HB Härte	Grade Sorte	Cutting data Schnittdaten		
			V (m/min)	f (mm/z)	a _{pmax}
P Low-carbon steel Soft steel Niedriglegierter Kohlenstoffstahl	≤180	YBM253	270 (220-350)	0.2 (0.1-0.3)	5
		YBG205			
Alloy tool steel Leg. Werkzeugstahl	180-350	YBM253	240 (180-320)	0.15 (0.1-0.3)	5
		YBG205			
M Stainless steel Rostfreier Stahl	≤270	YBM253	230 (180-300) 160 (110-270)	0.15 (0.1-0.3)	5
		YBG205			
K Cast iron Gusseisen	180-250	YBD152	270 (150-300)	0.2 (0.1-0.3)	5

● Ex Stock / ab Lager ○ On demand / auf Anfrage

FMD02



Entering angle $Kr=67^\circ$
Anstellwinkel $Kr=67^\circ$



Screw clamping
Schraubenspannsystem



10 Cutting edges
10 Schneidkanten



Wiper / Wiper



Insert grades:
WSP Sorten:

YBC302

CVD
P15 - P35

YBM253

CVD
P20 - P40

YBD152

CVD
K05 - K25



Clamping by wedge for highest accuracy and reliability.

Klemmkeilspannung für höchste Stabilität und Wiederholgenauigkeit.

Machining of cast iron
Gussbearbeitung
 $a_p \max=5 \text{ mm}$

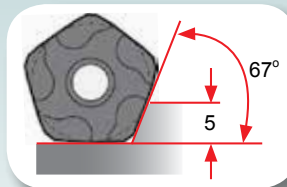

Steel, Alloy steel
Stahl, Legierter Stahl
 $a_p \max=7.5 \text{ mm}$

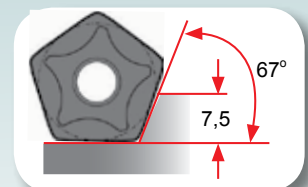

Holder/Halter	FMD02-100-B32-PN11-10 ZCC-CT	Competitor A / Wettbewerber A
Insert/ WSP	PNEG110512R-CR/YBD152	
Cutting data Schnittdaten	D=100 mm $a_p=3\text{--}5 \text{ mm}$ Vc=243 m/min $f_z=0.15 \text{ mm/Z}$ 145~155 pcs / Stück	D=100 mm $a_p=3\text{--}5 \text{ mm}$ Vc=243 m/min $f_z=0.12 \text{ mm/Z}$ 120~133 pcs / Stück

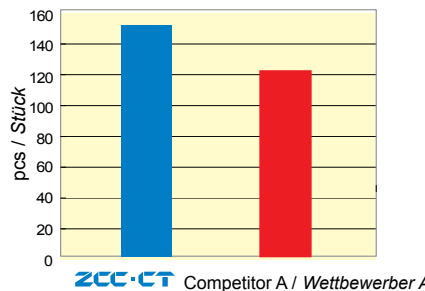

Comparison of wear / Verschleißvergleich

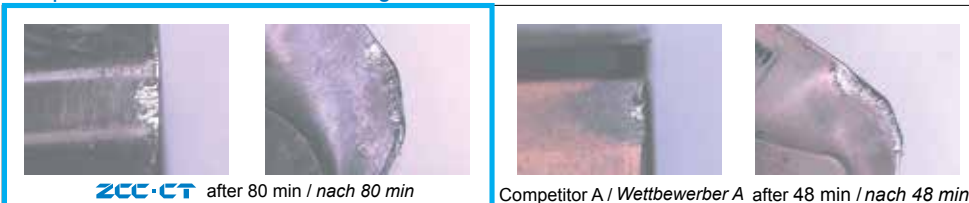

ZCC-CT after 80 min / nach 80 min

Competitor A / Wettbewerber A after 48 min / nach 48 min

Milling - Fräsen

Indexable Milling Tools - Wendepplattenfräser

Face milling / Planfräser

Kr:67°



FMD02 P K

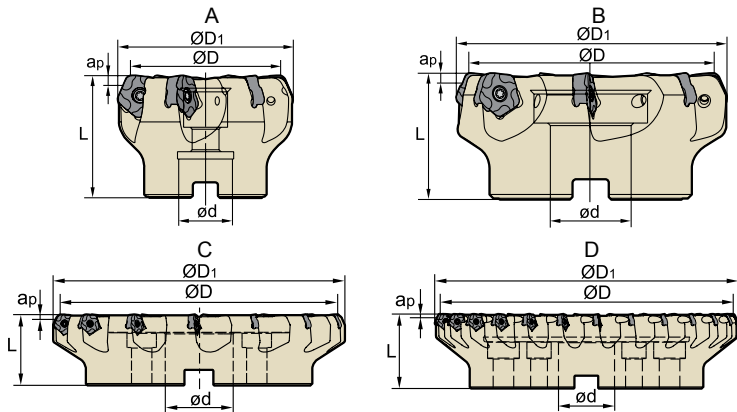

Type Typ	Stock Lager	Dimension Abmessung (mm)							Tooth Zähne Z	Coupling Aufnahme	Weight Gewicht (kg)
		R	L	ØD	ØD1	ød	L	apmax			
FMD02 -050-A22-PN11-04	● ●			50	60.1	22	50	5	A	0.6	
-050-A22-PN11-04C	* ○ ○			50	60.1	22	50	5	A	0.6	
-050-A22-PN11-05	● ○			50	60.1	22	50	5	A	0.6	
-050-A22-PN11-05C	* ● ○			50	60.1	22	50	5	A	0.6	
-063-A22-PN11-05	● ○			63	73.1	22	50	5	A	0.8	
-063-A22-PN11-05C	* ● ○			63	73.1	22	50	5	A	0.8	
-063-A22-PN11-06	● ○			63	73.1	22	50	5	A	0.9	
-063-A22-PN11-06C	* ● ○			63	73.1	22	50	5	A	0.9	
-080-A27-PN11-06	● ○			80	90.1	27	50	5	A	1.1	
-080-A27-PN11-06C	* ● ○			80	90.1	27	50	5	A	1.1	
-080-A27-PN11-08	● ○			80	90.1	27	50	5	A	1.2	
-080-A27-PN11-08C	* ● ○			80	90.1	27	50	5	A	1.2	
-100-B32-PN11-07	● ○			100	110.1	32	50	5	B	1.8	
-100-B32-PN11-07C	* ● ○			100	110.1	32	50	5	B	1.8	
-100-B32-PN11-10	● ○			100	110.1	32	50	5	B	1.9	
-100-B32-PN11-10C	* ● ○			100	110.1	32	50	5	B	1.9	
-125-B40-PN11-08	● ○			125	135.1	40	63	5	B	2.9	
-125-B40-PN11-08C	* ○ ○			125	135.1	40	63	5	B	2.9	
-125-B40-PN11-12	● ○			125	135.1	40	63	5	B	3.2	
-125-B40-PN11-12C	* ● ○			125	135.1	40	63	5	B	3.2	
-160-B40-PN11-10	● ○			160	170.1	40	63	5	B	5.6	
-160-B40-PN11-14	● ○			160	170.1	40	63	5	B	6.4	
-200-C60-PN11-12	○ ○			200	210.1	60	63	5	C	7.9	
-200-C60-PN11-16	● ○			200	210.1	60	63	5	C	8.5	
-200-C60-PN11-20	○ ○			200	210.1	60	63	5	C	8.5	
-200-C60-PN11-24	● ○			200	210.1	60	63	5	C	8.6	
-250-C60-PN11-14	○ ○			250	260.1	60	63	5	C	13.4	
-250-C60-PN11-18	● ○			250	260.1	60	63	5	C	18.0	
-250-C60-PN11-30	○ ○			250	260.1	60	63	5	C	13.5	
-315-D60-PN11-26	● ○			315	325.1	60	80	5	D	24.5	

Spare Parts - Ersatzteile

ØD	Screw / Schraube	Wrench / Schlüssel
	Ø50 - Ø315	 I60M4×10

Coupling Aufnahme	Diameter Durchmesser Ø D	Screw-Schraube	Ring-Dichtring
		B32	Ø100
B40	Ø125	LDB40C	B40-002-CP

● Ex Stock / ab Lager ○ On demand / auf Anfrage * With internal cooling · Mit Innenkühlung

Face Milling Tools · Planfräser

Kr:67°



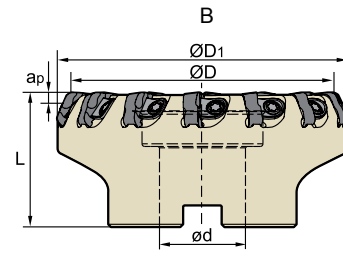
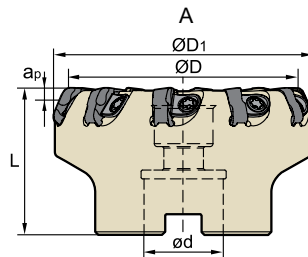

FMD02 **P** **K**





Type Typ	Stock Lager	Dimension Abmessung (mm)							Tooth Zähne Z	Coupling Aufnahme	Weight Gewicht (kg)
		R	L	ØD	ØD1	ød	L	ap _{max}			
FMD02	• ○	○	80	90.1	27	50	5	10	A	1.3	
	* ○	○	80	90.1	27	50	5	10	A	1.3	
	• ○	○	100	110.1	32	50	5	14	B	1.6	
	* •	○	100	110.1	32	50	5	14	B	1.6	
	• ○	○	125	135.1	40	63	5	18	B	3.2	
	* ○	○	125	135.1	40	63	5	18	B	3.2	
	• ○	○	160	170.1	40	63	5	22	B	5.8	
	• ○	○	200	210.1	60	63	5	28	C	8.5	
	○	○	200	210.1	60	63	5	36	C	8.5	

• Ex stock / ab Lager ○ On demand / auf Anfrage * With internal cooling · Mit Innenkühlung

Spare Parts · Ersatzteile

ØD	Wedge / Keil	Screw / Schraube	Wrench / Schlüssel
Ø80 - Ø200	 W18N	 DM6x20A	 WT15IT

Coupling Aufnahme	Diameter Durchmesser Ø D	Screw-Schraube	Ring-Dichtring
			
B32	-	LDB32C	B32-002-CP
B40	Ø125	LDB40C	B40-002-CP

Applicable tool **B11-B18**
Werkzeug

Tools code key **B26-B27**
Werkzeug ISO

Grade selection guide **B19-B23**
Sortenauswahl

Technical data **B236-B241**
Technische Daten

Milling - Fräsen

Indexable Milling - Fräswendepplatten

Applicable inserts Wendeschneidplatten

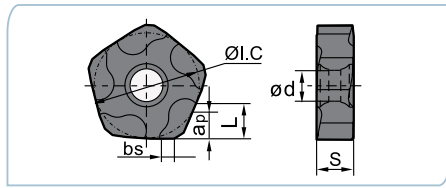

Workpiece Material Werkstoffe	Ideal Machining Condition Gute Bearbeitungsbedingungen			Normal Machining Condition Normale Bearbeitungsbedingungen			Unfavorable Machining Condition Ungünstige Bearbeitungsbedingungen								
	P	M	K	N	S	P	M	K	N	S	P	M	K	N	S
P Steel Stahl	●	●	●	●	●	●	●	●	●	●	●	●	●	●	●
M Stainless Steel Rostfreier Stahl	●	●	●	●	●	●	●	●	●	●	●	●	●	●	●
K Cast iron Gusseisen						●	●	●			●	●			●
N Non-ferrous material Ne Metalle															●
S Heat-resistant steel Wärmfester Stahl						●	●				●	●			●

WSP Insert	Typ Type	Dimension Abmessung (mm)						CVD Coating CVD Beschicht.						PVD Coating PVD Beschicht.						Cermet Cermet	Carbide uncoat. unb. Hartmetall											
		L	ØI.C	S	ød	bs	ap max	YBC302	YBC301	YBC401	YBM253	YBM251	YBM351	YBD152	YBD252	YBG102	YB9320	YBG205	YBG202		YBG212	YBG302	YBG152	YBG252	YNG151	YNG151C	YC30S	YD101	YD201			
	PNEG110512R-CF	5.4	15.875	5.56	4.64	1.6	5																									
	PNEG110512L-CF	5.4	15.875	5.56	4.64	1.6	5																									
	PNEG110512R-CM	5.4	15.875	5.56	4.64	1.6	5																									
	PNEG110512L-CM	5.4	15.875	5.56	4.64	1.6	5																									
	PNEG110512R-CR	5.4	15.875	5.56	4.64	1.6	5																									
	PNEG110512L-CR	5.4	15.875	5.56	4.64	1.6	5																									

Applicable inserts Wendeschneidplatten

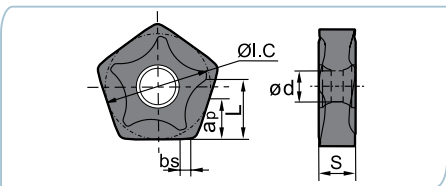

Workpiece Material Werkstoffe	Ideal Machining Condition Gute Bearbeitungsbedingungen			Normal Machining Condition Normale Bearbeitungsbedingungen			Unfavorable Machining Condition Ungünstige Bearbeitungsbedingungen								
	P	M	K	N	S	P	M	K	N	S	P	M	K	N	S
P Steel Stahl	●	●	●	●	●	●	●	●	●	●	●	●	●	●	●
M Stainless Steel Rostfreier Stahl	●	●	●	●	●	●	●	●	●	●	●	●	●	●	●
K Cast iron Gusseisen						●	●	●			●	●			●
N Non-ferrous material Ne Metalle															●
S Heat-resistant steel Wärmfester Stahl						●	●				●	●			●

WSP Insert	Typ Type	Dimension Abmessung (mm)						CVD Coating CVD Beschicht.						PVD Coating PVD Beschicht.						Cermet Cermet	Carbide uncoat. unb. Hartmetall											
		L	ØI.C	S	ød	bs	ap max	YBC302	YBC301	YBC401	YBM253	YBM251	YBM351	YBD152	YBD252	YBG102	YB9320	YBG205	YBG202		YBG212	YBG302	YBG152	YBG252	YNG151	YNG151C	YC30S	YD101	YD201			
	PNEG110512R-PF	7.5	15.875	5.56	4.64	1.6	7.5	●			○																					
	PNEG110512L-PF	7.5	15.875	5.56	4.64	1.6	7.5	○																								
	PNEG110512R-PM	7.5	15.875	5.56	4.64	1.6	7.5	●			●																					
	PNEG110512L-PM	7.5	15.875	5.56	4.64	1.6	7.5	○			○																					
	PNEG110512R-PR	7.5	15.875	5.56	4.64	1.6	7.5	○			●																					
	PNEG110512L-PR	7.5	15.875	5.56	4.64	1.6	7.5	○			○																					

Cutting Data / Schnittdaten

Workpiece material Werkstück Material	Hardness HB Härte	Grade Sorte	Cutting data / Schnittdaten					
			Vc(m/min)	fz(mm/z)			apmax(mm)	
				PF	PM	PR		
P Low-carbon steel Soft steel Niedriglegierter Kohlenstoffstahl Baustahl	≤180	YBM253	270 (220-350)	0.15 (0.1-0.2)	0.2 (0.1-0.3)	0.3 (0.2-0.4)	7.5	
		YBC302						
		High-carbon steel Alloy steel Hochleg. Kohlenstoffstahl						180-280
YBC302	Alloy tool steel Leg. Werkzeugstahl	280-350	YBM253	240 (180-300)	0.15 (0.1-0.2)	0.2 (0.1-0.3)	0.3 (0.2-0.4)	7.5
K Cast iron Gusseisen	180-250	YBD152	270 (150-300)	CF	CM	CR	5	
				0.15 (0.1-0.2)	0.2 (0.1-0.3)	0.3 (0.2-0.4)		

● Ex Stock / ab Lager ○ On demand / auf Anfrage

Face Milling Tools · Planfräser



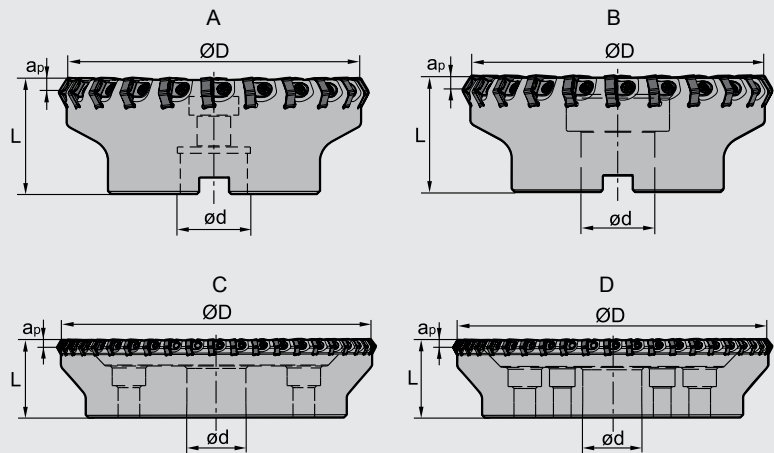

FMD02 K



Specification of tools · Werkzeug Beschreibung

Type Typ	Stock Lager	Dimension (mm) Abmessung						No. of teeth Zähne	Coupling Aufnahme	Weight Gewicht (kg)
		R	L	ØD	ød	L	apmax			
FMD02	○		80	27	50	6	8	A	1.19	
	○	○	80	27	50	6	10	A	1.1	
	○		100	32	50	6	10	B	1.77	
	○	○	100	32	63	6	14	B	2.6	
	○		125	40	63	6	14	B	3.55	
	○	○	125	40	63	6	18	B	3.7	
	○		160	40	63	6	18	B	5.62	
	○	○	160	40	63	6	22	B	5.6	
	○		200	60	63	6	22	C	6.7	
	○	○	200	60	63	6	28	C	6.3	
	○		250	60	63	6	28	C	13	
	○	○	250	60	63	6	36	C	10.3	
	○		315	60	63	6	32	C	21.7	
	○		315	60	63	6	44	C	21.7	
○	○	315	60	63	6	44	D	21.7		

Spare Parts · Ersatzteile

Diameter Durchmesser Ø D	Wedge Keil	Wedge screw Keilschraube	Wrench Schlüssel
Ø80-Ø315	 W18N	 DM6×20A	 WT15IT

Applicable tool B11-B18
Werkzeug

Tools code key B26-B27
Werkzeug ISO

Grade selection guide B19-B23
Sortenauswahl

Technical data B236-B241
Technische Daten

Milling · Fräsen

Indexable Milling · Fräswendeplatten

Applicable inserts · Wendeschneidplatten

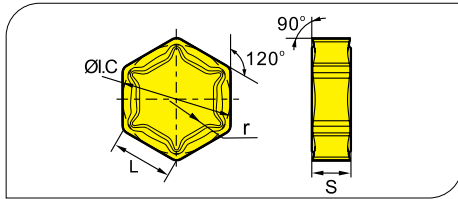

Workpiece Material Werkstoffe	Ideal Machining Condition Gute Bearbeitungsbedingungen			Normal Machining Condition Normale Bearbeitungsbedingungen			Unfavorable Machining Condition Ungünstige Bearbeitungsbedingungen		
	P	M	K	P	M	K	P	M	K
P Steel Stahl	●	●	●	●	●	●	●	●	●
M Stainless Steel Rostfreier Stahl		●	●	●	●	●	●	●	●
K Cast iron Gusseisen			●			●			●
N Non-ferrous material Nichte Metalle									●
S Heat-resistant steel Wärmefester Stahl							●	●	●

Plattenform Insert shape	Typ Type	Dimension (mm) Abmessung				CVD Coating CVD Beschicht.						PVD Coating PVD Beschicht.						Cermet Cermet	Carbide uncoat. unbe. Hartmetall									
		L	I.C.	S	r	YBC302	YBC301	YBC401	YBM253	YBM251	YBM351	YBD152	YBD252	YBG102	YB9320	YBG205	YBG202			YBG212	YBG302	YBG152	YBG252	YNG151	YNG151C	YC30S	YD101	YD201
	HNEX090512-DF	9.16	15.875	5.56	1.2						○																	
	HNEX090512-DM	9.16	15.875	5.56	1.2						○	○																
	HNEX090512-DR	9.16	15.875	5.56	1.2						●	●																

Chipbreaker Selection FMD02 · Spanbrecher Auswahl FMD02

Application Anwendung	Finishing Schlichten	Semi-Finishing Mittlere Bearbeitung	Roughing Schruppen
K	-DF	-DM	-DR

Recommended cutting data · Empfohlene Schnittdaten

Workpiece material Werkstückstoff	Hardness HB Härte	Grade Sorte	Cutting data Schnittdaten			
			V (m/min)	f (mm/z)		
				-DF	-DM	-DR
K Cast iron Gusseisen	180-250	YBD152	180 (110-250)	0.15(0.1-0.2)	0.2 (0.1-0.3)	0.3(0.2-0.5)
		YBD252	130 (110-200)	0.2(0.1-0.2)	0.25 (0.1-0.3)	0.3(0.2-0.5)

● Ex Stock / ab Lager ○ On demand / auf Anfrage

Face Milling Tools · Planfräser

Kr:60°



FMD03 P M K

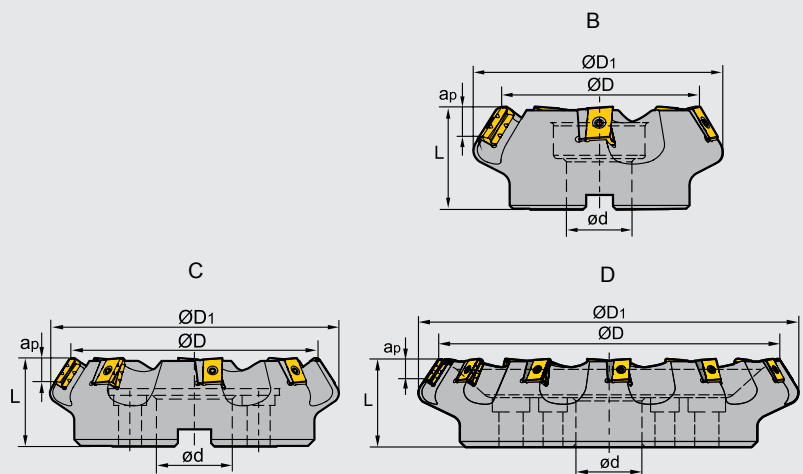

Specification of tools · Werkzeug Beschreibung

Type Typ	Stock Lager		Dimension(mm) Abmessung					No. of Teeth Zähne	Insert WSP	Coupling Aufnahme	Weight Gewicht (kg)	
	R	L	ØD	ØD ₁	Ød	L	a _{pmax}					
FMD03	-100-B32-LN20-05	●		100	129	32	63	12	5	LNKT2007DN-ZR	B	3.02
	-125-B40-LN20-06	●	○	125	153	40	63	12	6		B	4.5
	-160-C40-LN20-08	●	○	160	187	40	63	12	8		C	6.9
	-160-C40-LN20-09	●		160	187	40	63	12	9		C	6.7
	-200-C60-LN20-10	●	○	200	227	60	70	12	10		C	10.5
	-250-C60-LN20-12	●	○	250	276	60	70	12	12		C	13.4
	-315-D60-LN20-15	●	○	315	339	60	80	12	15	D	26.2	
	-125-B40-LN25-05	○	○	125	154	40	63	16	5	LNKT2510-ZR	B	4.5
	-160-C40-LN25-06	●	○	160	189	40	63	16	6		C	6.9
	-200-C60-LN25-08	●	○	200	229	60	70	16	8		C	10.5
	-250-C60-LN25-10	●	○	250	278	60	70	16	10		C	16.7
	-315-D60-LN25-12	●	○	315	346	60	80	16	12		D	27.3
-400-D60-LN25-16	●	○	400	427	60	80	16	16	D		47.1	

Spare Parts · Ersatzteile

Insert Platte	Cassette Kassette	Wedge screw Plattenschraube	Locator screw Unterlagsschraube	Wrench Schlüssel	
LNKT2007DN-ZR	LLN20R-ZR	I60M4×15	I60M3×7	WT15IS	WT10IS
LNKT2510-ZR	LLN25R-ZR	I60M5×17	I60M3.5×10.4	WT20IT	WT15IS

Applicable tool
Werkzeug **B11-B18**

Tools code key
Werkzeug ISO **B26-B27**

Grade selection guide
Sortenauswahl **B19-B23**

Technical data
Technische Daten **B236-B241**

B

Milling Tools
Fräser

Milling · Fräsen

Indexable Milling · Fräswendeplatten

Applicable inserts · Wendeschneidplatten

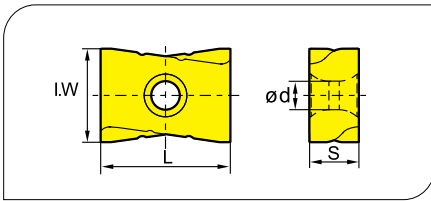

Workpiece Material Werkstoffe	Material Code	Ideal Machining Condition Gute Bearbeitungsbedingungen			Normal Machining Condition Normale Bearbeitungsbedingungen			Unfavorable Machining Condition Ungünstige Bearbeitungsbedingungen		
		Steel Stahl	Stainless Steel Rostfreier Stahl	Cast iron Gusseisen	Steel Stahl	Stainless Steel Rostfreier Stahl	Cast iron Gusseisen	Steel Stahl	Stainless Steel Rostfreier Stahl	Cast iron Gusseisen
P	Steel Stahl	●	●	●	●	●	●	●	●	●
M	Stainless Steel Rostfreier Stahl	●	●	●	●	●	●	●	●	●
K	Cast iron Gusseisen			●			●			●
N	Non-ferrous material Nichtmetalle									
S	Heat-resistant steel Wärmefester Stahl				●	●	●	●	●	●

Insert shape Plattenform	Type Typ	Dimension(mm) Abmessung				CVD Coating CVD Beschicht						PVD Coating PVD Beschicht				Cermets Cermet	Carbide uncoat. unbe. Hartmetall									
		L	I.W	S	ød	YBC302	YBC301	YBC401	YBM253	YBM251	YBM351	YBD152	YBD252	YBG102	YB9320			YBG205	YBG202	YBG212	YBG302	YBG152	YBG252	YNG151	YNG151C	YC30S
	LNKT2007DN-ZR	20	17	7.94	4.6				●	●	●								●							
	LNKT2510-ZR	25	18	9.525	5.5					●	●								●							

Recommended cutting data · Empfohlene Schnittdaten

Workpiece material Werkstückstoff	Hardness HB Härte	Grade Sorte	Cutting data Schnittdaten	
			V (m/min)	f (mm/z)
P Low-carbon steel Soft steel Niedriglegierter Kohlenstoffstahl Baustahl	≤180	YBG302	180 (150-300)	0.5 (0.2-0.8)
		YBM351	180 (150-300)	0.5 (0.2-0.8)
	180-280	YBG302	150 (120-280)	0.5 (0.2-0.8)
		YBM351	140 (120-280)	0.5 (0.2-0.8)
	280-350	YBG302	120 (80-250)	0.45 (0.2-0.6)
		YBM351	100 (80-250)	0.45 (0.2-0.6)
M Stainless steel Rostfreier Stahl	≤270	YBG302	120 (80-200)	0.45 (0.2-0.6)
		YBM351	100 (80-200)	0.45 (0.2-0.6)
K Cast iron Gusseisen	180-250	YBM351	100 (80-180)	0.5 (0.2-0.8)
		YBD252	130 (110-200)	0.5 (0.2-0.8)

● Ex Stock / ab Lager ○ On demand / auf Anfrage

Case study for FMD03 Bearbeitungsbeispiel für FMD03



- Tool · Werkzeug: FMD03-315-D60-LN25-12
- Inserts · WSP: LNKT2510-ZR/YBG302

Workpiece material
Werkstoff : ASTMA743 CA-6NM class(HB200)

Cooling system: dry cutting
Kühlsystem: trocken

Machine
Maschine: vertikales Maschinen-Center
NC floor Type · Typ boring and milling machine,
spindle power ≥ 30 KW
Bohr-Fräszentrum Spindelleistung 230 KW

Cutting data
Schnittdaten: $V_c=200$ m/min
 $f_z=0.6$ mm/z
 $a_p=10$ mm



• Wear comparison of insert Verschleißvergleich der WSP

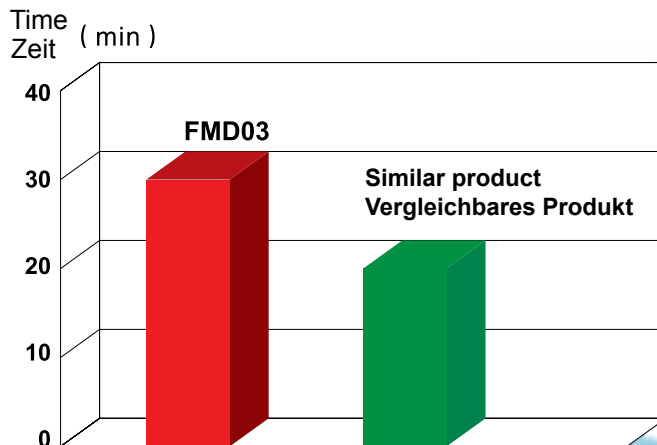

Milling · Fräsen

Indexable Milling Tools · Wendeplattenfräser

Face Milling Tools · Planfräser

Kr:75°



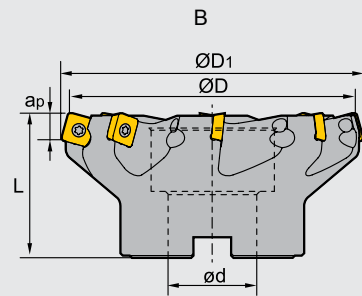
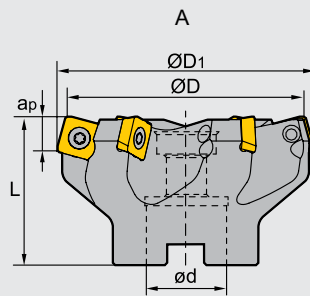

FME02 P M K



Specification of tools · Werkzeug Beschreibung

Type Typ	Stock Lager	Dimension (mm) Abmessung					No. of teeth Zähne	Coupling Aufnahme	Weight Gewicht (kg)
		Ø D	Ø D ₁	Ø d	L	ap _{max}			
FME02	●	50	54	22	40	6	4	A	0.3
	●	63	66	22	50	6	5	A	0.6
	●	80	83	27	50	6	6	A	0.9
	●	100	103	32	50	6	7	B	1.4
	●	125	128	40	63	6	8	B	2.5

Spare Parts · Ersatzteile

Diameter Durchmesser Ø D	Screw Schraube	Wrench Schlüssel
Ø50-Ø125	 I60M5×13.2	 WT20IS



● Ex Stock / ab Lager ○ On demand / auf Anfrage

Applicable inserts · Wendeschneidplatten

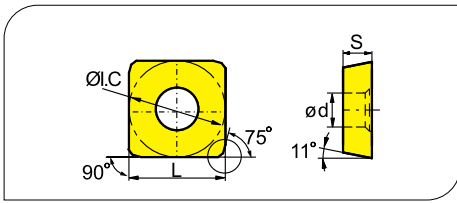

Workpiece Material Werkstoffe	P Steel Stahl	M Stainless Steel Rostfreier Stahl	K Cast iron Gusseisen	N Non-ferrous material Nichtmetalle	S Heat-resistant steel Wärmefester Stahl	Ideal Machining Condition Gute Bearbeitungsbedingungen			Normal Machining Condition Normale Bearbeitungsbedingungen			Unfavorable Machining Condition Ungünstige Bearbeitungsbedingungen		
						●	●	●	●	●	●	●	●	●
P	●	●	●	●	●	●	●	●	●	●	●	●	●	●
M	●	●	●	●	●	●	●	●	●	●	●	●	●	●
K	●	●	●	●	●	●	●	●	●	●	●	●	●	●
N	●	●	●	●	●	●	●	●	●	●	●	●	●	●
S	●	●	●	●	●	●	●	●	●	●	●	●	●	●

Plattenform Insert shape	Typ Type	Dimension (mm) Abmessung				CVD Coating CVD Beschicht.						PVD Coating PVD Beschicht.					Cermets Cermets	Carbide uncoat. unbe. Hartmetall									
		L	I.C	S	d	YBC302	YBC301	YBC401	YBM253	YBM251	YBM351	YBD152	YBD252	YBG102	YB9320	YBG205		YBG202	YBG212	YBG302	YBG152	YBG252	YNG151	YNG151C	YC30S	YD101	YD201
	SPKW1204EDFR	12.7	12.7	4.76	5.56																						
	SPKW1204EDSR	12.7	12.7	4.76	5.56																						
	SPKT1204EDR	12.7	12.7	4.76	5.56																						

B

Milling Tools
Fräser

Chipbreaker Selection FME02 · Spanbrecher Auswahl FME02

Application Anwendung	Finishing Schlichten	Semi-Finishing Mittlere Bearbeitung	Roughing Schruppen
P	EDFR	EDR	EDSR
M	EDFR	EDR	
K	EDFR	EDR	

Recommended cutting data · Empfohlene Schnittdaten

Workpiece material Werkstückstoff	Hardness HB Härte	Grade Sorte	Cutting data Schnittdaten	
			V (m/min)	f (mm/z)
P Low-carbon steel Soft steel Niedriglegierter Kohlenstoffstahl Baustahl	≤180	YBG202	270(200-360)	0.2 (0.1-0.3)
	180-280	YBG202	240 (180-350)	0.2 (0.1-0.3)
	280-350	YBG202	220 (170-340)	0.2 (0.1-0.3)
M Stainless steel Rostfreier Stahl	≤270	YBG202	160 (110-270)	0.2 (0.1-0.3)
K Cast iron Gusseisen	180-250	YBG202	160 (120-200)	0.2 (0.1-0.3)

Applicable tool
Werkzeug **B11-B18**

Tools code key
Werkzeug ISO **B26-B27**

Grade selection guide
Sortenauswahl **B19-B23**

Technical data
Technische Daten **B236-B241**

Kr:75°



Face Milling Tools · Planfräser

FME03 P M K

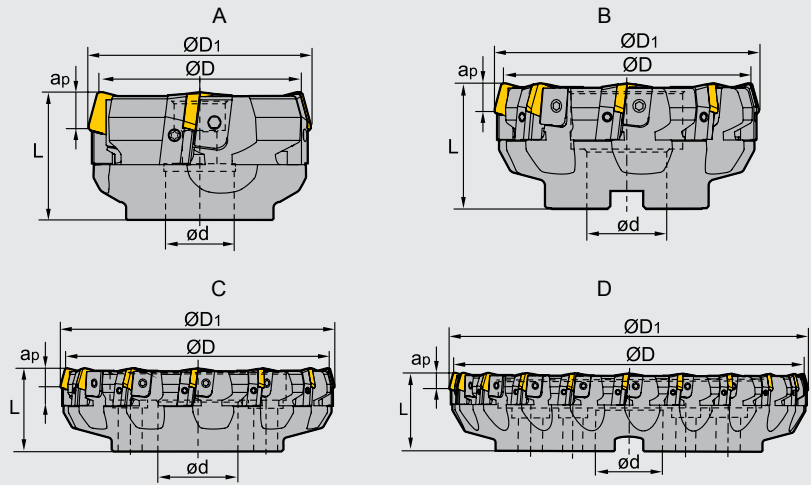

Specification of tools · Werkzeug Beschreibung

Type Typ	Stock Lager		Dimension (mm) Abmessung					No. of teeth Zähne	Coupling Aufnahme	Weight Gewicht (kg)
	R	L	Ø D	Ø D ₁	Ø d	L	ap _{max}			
FME03										
-080-A27-SP12-04	○	○	80	84	27	50	6	4	A	1.1
-100-B32-SP12-06	●	○	100	104	32	50	6	6	B	1.9
-125-B40-SP12-08	●	○	125	129	40	63	6	8	B	3.5
-160-B40-SP12-10	●	○	160	164	40	63	6	10	B	5.7
-200-C60-SP12-12	●	○	200	203	60	63	6	12	C	8.2
-250-C60-SP12-16	●	●	250	253	60	63	6	16	C	13.8
-315-D60-SP12-20	○	○	315	318	60	70	6	20	D	23.5
-080-A27-SP15-04	○	○	80	84	27	50	8	4	A	1.0
-100-B27-SP15-06	○	○	100	104	27	50	8	6	B	1.8
-125-B40-SP15-08	●	○	125	129	40	63	8	8	B	3.3
-160-B40-SP15-10	●	○	160	164	40	63	8	10	B	5.4
-200-C60-SP15-12	○	○	200	204	60	63	8	12	C	7.9
-250-C60-SP15-16	○	○	250	253	60	63	8	16	C	13.6
-315-D60-SP15-20	○	○	315	318	60	70	8	20	D	23.1

Spare Parts · Ersatzteile

Diameter Durchmesser Ø D	Insert Platte	Cassette Kassette	Wedge Keil	Screw Schraube	Locator screw Schraube	Wrench Schlüssel	
Ø80-Ø100	SP12	LSP12R/L	W04R/L	WM8×17	LOM5×15.1	WT20T WT25T	
Ø125-Ø315				WM8×22			
Ø80-Ø315	SP15	LSP15R/L	W04R/L	WM8×22			

● Ex Stock / ab Lager ○ On demand / auf Anfrage

Milling - Fräsen

Indexable Milling - Fräswendeplatten

Applicable inserts · Wendeschneidplatten

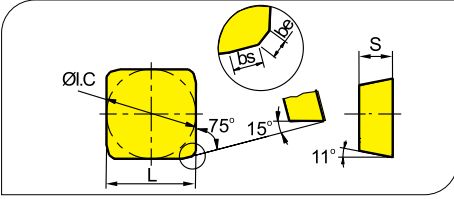

Workpiece Material Werkstoffe	Ideal Machining Condition Gute Bearbeitungsbedingungen	Normal Machining Condition Normale Bearbeitungsbedingungen	Unfavorable Machining Condition Ungünstige Bearbeitungsbedingungen
P Steel Stahl	●	●	●
M Stainless Steel Rostfreier Stahl	●	●	●
K Cast iron Gusseisen	●	●	●
N Non-ferrite material Ne Metalle	●	●	●
S Heat-resistant steel Wärmfester Stahl	●	●	●

Insert WSP	Type Typ	Dimensions (mm) Abmessungen					CVD Coating CVD Beschicht.						PVD Coating PVD Beschicht.						Cermets Cermet	Carbide uncoat. unbe. Hartmetall								
		L	I.C	S	be	bs	YBC302	YBC301	YBC401	YBM253	YBM251	YBM351	YBD152	YBD252	YBG102	YB9320	YBG205	YBG202		YBG212	YBG302	YBG152	YBG252	YNG151	YNG151C	YC30S	YD101	YD201
	SPKN1203EDER	12.7	12.7	3.18	1	1.4																						
	SPKN1203EDEL	12.7	12.7	3.18	1	1.4																						
	SPKN1203EDFR	12.7	12.7	3.18	1	1.4	●							●													●	
	SPKN1203EDFL	12.7	12.7	3.18	1	1.4																						●
	SPKN1203EDSKR	12.7	12.7	3.18	1	1.4	●	●						●					●	●						●		
	SPKN1203EDSKL	12.7	12.7	3.18	1	1.4	●											●								●		
	SPKN1203EDTKR	12.7	12.7	3.18	1	1.4	○						●								●					●		
	SPKN1203EDTKL	12.7	12.7	3.18	1	1.4																						
	SPKN1203EDS31PR	12.7	12.7	3.18	1	1.4												○										
	SPKN1203EDS31PL	12.7	12.7	3.18	1	1.4																						
	SPKN1203EDT31R	12.7	12.7	3.18	1	1.4																						
	SPKN1203EDT31L	12.7	12.7	3.18	1	1.4																						
	SPKR1203EDR	12.7	12.7	3.18	1	1.4	●																			●		
	SPKR1203EDR-GM	12.7	12.7	3.18	1	1.4				●																		
	SPKR1203EDL-GM	12.7	12.7	3.18	1	1.4				●																		
	SPKN1504EDER	15.875	15.875	4.76	1	1.4																						
	SPKN1504EDEL	15.875	15.875	4.76	1	1.4																						
	SPKN1504EDFR	15.875	15.875	4.76	1	1.4																					●	
	SPKN1504EDFL	15.875	15.875	4.76	1	1.4																						●
	SPKN1504EDL	15.875	15.875	4.76	1	1.4																				●	●	
	SPKN1504EDSKR	15.875	15.875	4.76	1	1.4	●							●				●	●						●			
	SPKN1504EDSKL	15.875	15.875	4.76	1	1.4												●										
	SPKN1504EDTKR	15.875	15.875	4.76	1	1.4												●										
	SPKN1504EDTKL	15.875	15.875	4.76	1	1.4																						
	SPKN1504EDS32PR	15.875	15.875	4.76	1	1.4						○								●								
	SPKN1504EDS32PL	15.875	15.875	4.76	1	1.4																						
	SPKN1504EDT32PR	15.875	15.875	4.76	1	1.4													●									
SPKN1504EDT32PL	15.875	15.875	4.76	1	1.4																							
	SPKR1504EDR-GM	15.875	15.875	4.76	1	1.4				●								●										
	SPKR1504EDL-GM	15.875	15.875	4.76	1	1.4				●								●										

SPKN1203EDT31R chamfer · Fase 20° X 0.15 mm

Applicable tool
Werkzeug **B11-B18**

Tools code key
Werkzeug ISO **B26-B27**

Grade selection guide
Sortenauswahl **B19-B23**

Technical data
Technische Daten **B236-B241**

Milling · Fräsen

Indexable Milling · Fräswendepplatten

Applicable inserts · Wendeschneidplatten

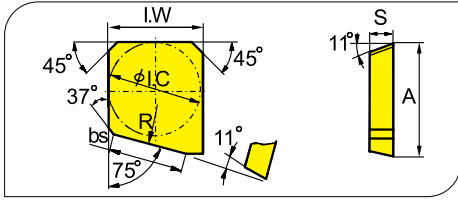

Workpiece Material Werkstoffe	Ideal Machining Condition Gute Bearbeitungsbedingungen			Normal Machining Condition Normale Bearbeitungsbedingungen			Unfavorable Machining Condition Ungünstige Bearbeitungsbedingungen		
	P	M	K	P	M	K	P	M	K
P Steel Stahl	●	●	●	●	●	●	●	●	●
M Stainless Steel Rostfreier Stahl	●	●	●	●	●	●	●	●	●
K Cast iron Gusseisen							●	●	●
N Non-ferrite material Ne Metalle									●
S Heat-resistant steel Warmfester Stahl				●	●		●	●	

Insert shape Plattenform	Type Typ	Dimension (mm) Abmessung						CVD Coating CVD Beschicht.						PVD Coating PVD Beschicht.						Cermets Cermets	Carbide uncoat. unbe. Hartmetall										
		A	I.C	I.W	S	bs	R	YBC302	YBC301	YBC401	YBMZ53	YBMZ51	YBM351	YBD152	YBD252	YBG102	YB9320	YBG205	YBG202		YBG212	YBG302	YBG152	YBG252	YNG151	YNG151C	YC30S	YD101	YD201		
	SPEX1203EDL-1	15	12.7	12.7	3.18	10	500																								○
	SPEX1203EDR-1	15	12.7	12.7	3.18	10	500																								○
	SPEX1504EDL-1	18.2	15.875	15.875	4.76	10	500																								●
	SPEX1504EDR-1	18.2	15.875	15.875	4.76	10	500																								●

Edge preparation for FME03 Schneidkantenausführung für FME03

Edge preparation Schneidkantenausführung	Recommended selection Beschreibung
SP**EDER/L	Rounded cutting edge for semi-finishing and finishing of steel and stainless steel. Verrundete Schneidkante für die Mittlere- bis Schlichtbearbeitung von Stahl und rostfreiem Stahl.
SP**EDFR/L	Sharp cutting edge for finishing of cast iron. Scharfe Schneidkante für die Schlichtbearbeitung von Gussmaterial.
SP**EDSKR/L SP**EDS**R/L	Rounded and chamfered cutting edge is suitable for roughing applications under unfavorable conditions. Gefaste Schneidkante mit Verrundung und guter Stabilität. Für Schruppbearbeitung von Stahl auch bei ungünstigen Verhältnissen.
SP**EDTKR/L SP**EDT**R/L	Chamfered edge for semi-finishing and finishing of steel, stainless steel and cast iron materials. Gefaste Schneide für mittlere bis Schlichtbearbeitung von Stahl und rostfreiem Stahl sowie Guss.
SP**EDR/L-GM	3D chipbreaker to reduce cutting force, reinforce the capability of chip control, improve insert life. Widely applied for semi-finish machining steel, stainless steel and cast iron materials. 3-D Spanbrecher für weniger Schnittkräfte, für gute Spankontrolle und höhere Standzeiten. Großer Anwendungsbereich geeignet für die mittlere Bearbeitung von Stahl, rostfreiem Stahl und Guss.

● Ex Stock / ab Lager ○ On demand / auf Anfrage

Recommended cutting data · Empfohlene Schnittdaten

	Workpiece material Werkstückstoff	Hardness HB Härte	Grade Sorte	Cutting data Schnittdaten	
				V (m/min)	f (mm/z)
P	Low-carbon steel Soft steel Niedrig legierter Kohlenstoffstahl Baustahl	≤180	YBG202	270(200-360)	0.2 (0.1-0.4)
			YBG205		
			YBG302	230 (170-350)	0.24 (0.1-0.3)
			YBM251	270(220-350)	0.2 (0.1-0.4)
			YBC301		
	YBM351	220 (180-300)	0.25 (0.15-0.3)		
	YC30S	140 (100-220)	0.22 (0.1-0.3)		
	High-carbon steel Alloy steel Hoch Leg. Kohlenstoffstahl	180-280	YBG202	240 (180-350)	0.2 (0.1-0.3)
			YBG205		
			YBG302	220 (150-330)	0.24 (0.1-0.3)
			YBM251	240 (200-320)	0.2 (0.1-0.4)
			YBC301		
	YBM351	200 (160-280)	0.25 (0.15-0.3)		
	YC30S	120 (80-200)	0.22 (0.1-0.3)		
	Alloy tool steel Leg. Werkzeugstahl	280-350	YBG202	220 (170-340)	0.2 (0.1-0.3)
YBG205					
YBG302			190 (130-300)	0.24 (0.1-0.3)	
YBM251			220 (180-300)	0.2 (0.1-0.4)	
YBC301					
YBM351	180 (150-250)	0.25 (0.15-0.3)			
YC30S	100 (60-180)	0.22 (0.1-0.3)			
M	Stainless steel Rostfreier Stahl	≤270	YBG202	160 (110-270)	0.2 (0.1-0.3)
			YBG205		
			YBG302	140 (100-250)	0.24 (0.1-0.3)
			YBM251	150 (120-240)	0.2 (0.1-0.4)
K	Cast iron Gusseisen	180-250	YBG102	210 (120-300)	0.12 (0.08-0.3)
			YBG302		
			YD201	160 (120-200)	0.2 (0.1-0.3)
			100 (80-160)	0.24 (0.15-0.4)	

Face Milling Tools · Planfräser

Kr:75°



FME04 **P** **M** **K**

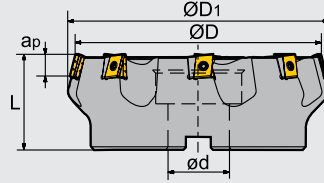

Specification of tools · Werkzeug Beschreibung

Type Typ	Stock Lager	Dimension (mm) Abmessung							No. of teeth Zähne	Coupling Aufnahme	Weight Gewicht (kg)
		R	L	Ø D	Ø D ₁	Ø d	L	ap _{max}			
FME04	-125-B40-LN15-06	●	○	125	137	40	63	10	6	B	3.8
	-160-B40-LN15-08	●	○	160	170	40	63	10	8	C	6.6
	-200-C60-LN15-10	●	○	200	208	60	70	10	10	C	9.6
	-250-C60-LN15-12	●	○	250	257	60	70	10	12	C	13.4
	-315-D60-LN15-16	●	○	315	328	60	80	10	16	D	25.2

Spare Parts · Ersatzteile

Diameter Durchmesser Ø D	Shim Unterlage	Wedge screw Plattenschraube	Locator screw Unterlagsschraube	Wrench Schlüssel
Ø80 Ø100	LLN15-ZR	I60M4×12	I60M3×7	WT15IS
Ø125 ~ Ø315				WT10IS



● Ex Stock / ab Lager ○ On demand / auf Anfrage

Applicable inserts · Wendeschneidplatten

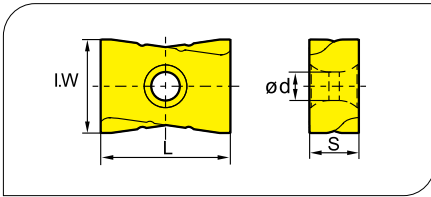

Workpiece Material Werkstoffe	P Steel Stahl	M Stainless Steel Rostfreier Stahl	K Cast iron Gusseisen	N Non-ferrite material Ne Metalle	S Heat-resistant steel Wärmfester Stahl	Ideal Machining Condition Gute Bearbeitungsbedingungen			Normal Machining Condition Normale Bearbeitungsbedingungen			Unfavorable Machining Condition Ungünstige Bearbeitungsbedingungen		
						●	●	●	●	●	●	●	●	●
P	●	●	●	●	●	●	●	●	●	●	●	●	●	●
M	●	●	●	●	●	●	●	●	●	●	●	●	●	●
K	●	●	●	●	●	●	●	●	●	●	●	●	●	●
N	●	●	●	●	●	●	●	●	●	●	●	●	●	●
S	●	●	●	●	●	●	●	●	●	●	●	●	●	●

Insert shape Plattenform	Type Typ	Dimension (mm) Abmessung				CVD Coating CVD Beschicht.						PVD Coating PVD Beschicht.				Cermet Cermet	Carbide uncoat. unbe. Hartmetall									
		L	I.W	S	d	YBC302	YBC301	YBC401	YBM253	YBM251	YBM351	YBD152	YBD252	YBG102	YB9320	YBG205	YBG202	YBG212	YBG302	YBG152	YBG252	YNG151	YNG151C	YC30S	YD101	YD201
	LNKT1506EN-ZR	15.875	14	6.35	4.6	●				●	●	●							●							

Recommended cutting data · Empfohlene Schnittdaten

Workpiece material Werkstückstoff	Hardness HB Härte	Grade Sorte	Cutting data Schnittdaten	
			V (m/min)	f (mm/z)
P Low-carbon steel Soft steel Niedrig legierter Kohlenstoffstahl Baustahl	≤180	YBG302	180 (150-300)	0.5 (0.2-0.8)
		YBM351	180 (150-300)	0.5 (0.2-0.8)
	180-280	YBG302	150 (120-280)	0.5 (0.2-0.8)
		YBM351	140 (120-280)	0.5 (0.2-0.8)
Alloy tool steel Leg. Werkzeugstahl	280-350	YBG302	120 (80-250)	0.45 (0.2-0.6)
		YBM351	100 (80-250)	0.45 (0.2-0.6)
M Stainless steel Rostfreier Stahl	≤270	YBG302	120 (80-200)	0.45 (0.2-0.6)
		YBM351	100 (80-200)	0.45 (0.2-0.6)
K Cast iron Gusseisen	180-250	YBD152	150 (120-200)	0.3 (0.2-0.5)
		YBD252	130 (110-200)	0.3 (0.2-0.5)

Applicable tool
Werkzeug **B11-B18**

Tools code key
Werkzeug ISO **B26-B27**

Grade selection guide
Sortenauswahl **B19-B23**

Technical data
Technische Daten **B236-B241**

Milling · Fräsen

Indexable Milling Tools · Wendeplattenfräser

Face Milling Tools · Planfräser

Kr:90°



FMP01 **P** **M** **K**

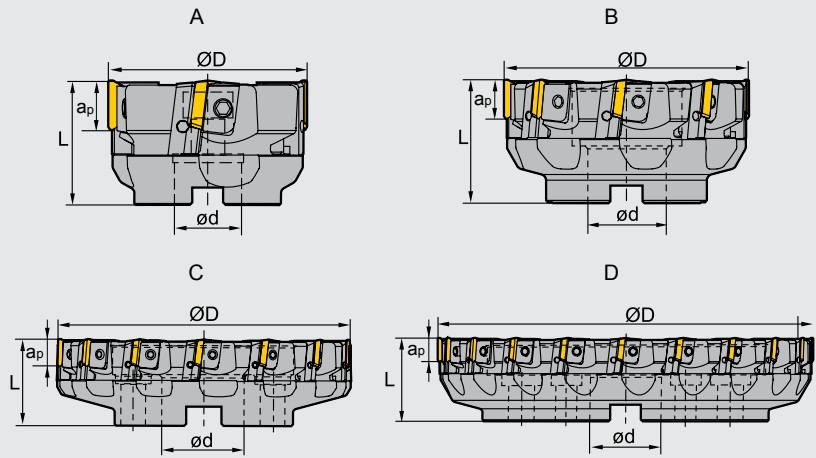

Specification of tools · Werkzeug Beschreibung

Type Typ	Stock Lager		Dimension (mm) Abmessung				No. of teeth Zähne	Coupling Aufnahme	Weight Gewicht (kg)
	R	L	Ø D	Ø d	L	apmax			
FMP01 -080-A27-TP22-04	●	○	80	27	50	18	4	A	1.2
-100-B32-TP22-06	●	○	100	32	50	18	6	B	1.7
-125-B40-TP22-08	●	○	125	40	63	18	8	B	3.2
-160-B40-TP22-10	●	○	160	40	63	18	10	B	5.1
-200-C60-TP22-12	●	○	200	60	63	18	12	C	7.4
-250-C60-TP22-16	○	○	250	60	63	18	16	C	12.3
-315-D60-TP22-20	○	○	315	60	70	18	20	D	21.9

Spare Parts · Ersatzteile

Diameter Durchmesser Ø D	Cassette Kassette	Wedge Keil	Screw Schraube	Locator screw Schraube	Wrench Schlüssel
Ø80 Ø100	LTP4R1/L1	W04R/L	WM8×17	LOM5×15.1	WT20T
Ø125 ~ Ø315	LTP4R/L		WM8×22		WT25T

● Ex Stock / ab Lager ○ On demand / auf Anfrage

Milling · Fräsen

Indexable Milling · Fräswendeplatten

Applicable inserts · Wendeschneidplatten

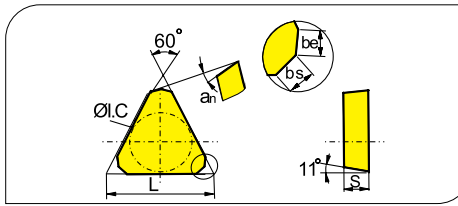

Workpiece Material Werkstoffe	Ideal Machining Condition Gute Bearbeitungsbedingungen			Normal Machining Condition Normale Bearbeitungsbedingungen			Unfavorable Machining Condition Ungünstige Bearbeitungsbedingungen		
	P	M	K	P	M	K	P	M	K
Steel Stahl	●	●	●	●	●	●	●	●	●
Stainless Steel Rostfreier Stahl	●	●	●	●	●	●	●	●	●
Cast iron Gusseisen						●	●	●	●
Non-ferrous material Nichtmetalle									●
Heat-resistant steel Wärmebeständiger Stahl							●	●	●

Insert WSP	Type Typ	Dimensions (mm) Abmessungen						CVD Coating CVD Beschicht.				PVD Coating PVD Beschicht.				Cermets Cermet	Carbide uncoat. unbe. Hartmetall												
		L	I.C.	S	be	bs	an	YBC302	YBC301	YBC401	YBM253	YBM251	YBM351	YBD152	YBD252		YBG102	YBG320	YBG205	YBG202	YBG212	YBG302	YBG152	YBG252	YNG151	YNG151C	YC30S	YD101	YD201
	TPKN2204PDKR	22	12.7	4.76	1.4	0.7	11°									●													
	TPKN2204PDFR	22	12.7	4.76	1.4	0.7	11°									●													●
	TPKN2204PDFL	22	12.7	4.76	1.4	0.7	11°																						○
	TPKN2204PDSKR	22	12.7	4.76	1.4	0.7	11°	●	●			●	●					●	●		●						●		
	TPKN2204PDL	22	12.7	4.76	1.4	0.7	11°		●																		●		●
	TPKN2204PDTR	22	12.7	4.76	1.4	0.7	11°		○									●									●		
	TPKN2204PDS32PR	22	12.7	4.76	0.693	1.411	11°														●								
	TPKN2204PDSKL	22	12.7	4.76	1.419	0.712	11°		●																				
	TPKN2204PDR	22	12.7	4.76	1.4	0.7	11°														●								

Recommended cutting data · Empfohlene Schnittdaten

Workpiece material Werkstückstoff	Hardness HB Härte	Grade Sorte	Cutting data Schnittdaten	
			V (m/min)	f (mm/z)
P Low-carbon steel Soft steel Niedriglegierter Kohlenstoffstahl Baustahl	≤180	YBC301	270 (220-350)	0.2 (0.1-0.4)
		YBM351	220 (180-300)	0.2 (0.08-0.3)
		YBG202	270 (200-360)	0.2 (0.1-0.3)
		YC30S	140 (100-220)	0.22 (0.1-0.3)
	180—280	YBC301	240 (200-320)	0.2 (0.1-0.4)
		YBM351	200 (160-280)	0.2 (0.08-0.3)
		YBG202	240 (180-350)	0.2 (0.1-0.3)
		YC30S	120 (80-200)	0.22 (0.1-0.3)
	280—350	YBC301	220 (180-300)	0.2 (0.1-0.4)
		YBM351	180 (150-250)	0.2 (0.08-0.3)
		YBG202	220 (170-340)	0.2 (0.1-0.3)
		YC30S	100 (60-180)	0.22 (0.1-0.3)
M Stainless steel Rostfreier Stahl	≤270	YBM351	140 (100-240)	0.2 (0.08-0.3)
		YBG202	140 (100-250)	0.2 (0.1-0.3)
		YBG102	210 (120-300)	0.2 (0.1-0.3)
K Cast iron Gusseisen	180—250	YBG302	160 (120-200)	0.35 (0.10-0.4)
		YD201	100 (80-160)	0.24 (0.15-0.4)

Applicable tool
Werkzeug **B11-B18**

Tools code key
Werkzeug ISO **B26-B27**

Grade selection guide
Sortenauswahl **B19-B23**

Technical data
Technische Daten **B236-B241**

Milling · Fräsen

Indexable Milling Tools · Wendeplattenfräser

Kr:90°



Face Milling Tools · Planfräser

FMP02 P M K

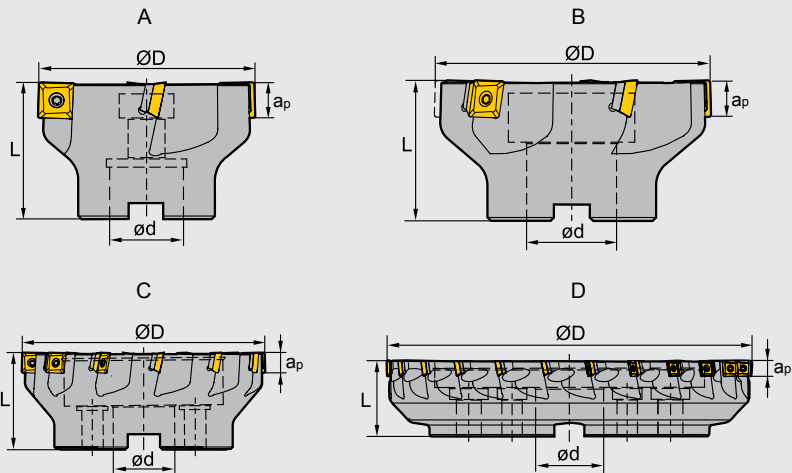

Specification of tools · Werkzeug Beschreibung

Type Typ	*	Stock Lager	Dimension (mm) Abmessung				No. of teeth Zähne	Coupling Aufnahme	Weight Gewicht (kg)
			Ø D	Ø D	L	apmax			
FMP02 -050-A22-SE09-05		●	50	22	40	6.7	5	A	0.3
-050-A22-SE09-05C	*	●	50	22	40	6.7	5	A	0.3
-063-A22-SE09-06		●	63	22	40	6.7	6	A	0.5
-063-A22-SE09-06C	*	●	63	22	40	6.7	6	A	0.5
-080-A27-SE09-08		●	80	27	50	6.7	8	A	0.9
-080-A27-SE09-08C	*	●	80	27	50	6.7	8	A	0.9
-100-B32-SE09-08		○	100	32	50	6.7	8	B	1.7
-100-B32-SE09-08C	*	○	100	32	50	6.7	8	B	1.7
-100-B32-SE09-10		○	100	32	50	6.7	10	B	1.7
-100-B32-SE09-10C	*	○	100	32	50	6.7	10	B	1.7
-125-B40-SE09-12		●	125	40	63	6.7	12	B	2.6
-125-B40-SE09-12C	*	●	125	40	63	6.7	12	B	2.6

Spare Parts · Ersatzteile

Diameter Durchmesser Ø D	Insert Platte	shim Unterlage	Screw Schraube	shim Unterlage Schraube	Wrench Schlüssel	Wrench Schlüssel
Ø50 ~ Ø125	SE09	--	I60M3×7	--	WT09IS	--
Ø50	SE12	--	I60M3.5×10	--	WT15IS	--
Ø63 ~ Ø315		S12BSX	I60M3.5×12	SM5×7XA		WH35L

Coupling Aufnahme	Diameter Durchmesser Ø D	Screw-Schraube	Ring-Dichtring
		B32	Ø100
B40	Ø125	LDB40C	B40-002-CP

● Ex Stock / ab Lager ○ On demand / auf Anfrage * With internal cooling · Mit Innenkühlung

■ Specification of tools · Werkzeug Beschreibung

Type Typ	*	Stock Lager	Dimension (mm) Abmessung				No. of teeth Zähne	Coupling Aufnahme	Weight Gewicht (kg)
			Ø D	Ø D	L	apmax			
FMP02		●	50	22	40	10.8	3	A	0.3
-050-A22-SE12-03C	*	○	50	22	40	10.8	3	A	0.3
-063-A22-SE12-04		●	63	22	40	10.8	4	A	0.4
-063-A22-SE12-04C	*	○	63	22	40	10.8	4	A	0.4
-080-A27-SE12-04		●	80	27	50	10.8	4	A	0.9
-080-A27-SE12-04C	*	○	80	27	50	10.8	4	A	0.9
-100-B32-SE12-05		●	100	32	50	10.8	5	B	1.2
-100-B32-SE12-05C	*	○	100	32	50	10.8	5	B	1.2
-125-B40-SE12-06		●	125	40	63	10.8	6	B	3.1
-125-B40-SE12-06C	*	○	125	40	63	10.8	6	B	3.1
-160-C40-SE12-08		●	160	40	63	10.8	8	C	4.1
-250-C60-SE12-12		○	250	60	63	10.8	12	C	11.1
-050-A22-SE12-04		●	50	22	40	10.8	4	A	0.3
-050-A22-SE12-04C	*	●	50	22	40	10.8	4	A	0.3
-063-A22-SE12-05		●	63	22	40	10.8	5	A	0.4
-063-A22-SE12-05C	*	●	63	22	40	10.8	5	A	0.4
-080-A27-SE12-06		●	80	27	50	10.8	6	A	0.8
-080-A27-SE12-06C	*	●	80	27	50	10.8	6	A	0.8
-100-B32-SE12-07		●	100	32	50	10.8	7	B	1.2
-100-B32-SE12-07C	*	○	100	32	50	10.8	7	B	1.2
-125-B40-SE12-08		●	125	40	63	10.8	8	B	3.0
-125-B40-SE12-08C	*	○	125	40	63	10.8	8	B	3.0
-160-C40-SE12-12		●	160	40	63	10.8	12	C	3.9
-050-A22-SE12-05		●	50	22	40	10.8	5	A	0.2
-050-A22-SE12-05C	*	○	50	22	40	10.8	5	A	0.2
-063-A22-SE12-06		●	63	22	40	10.8	6	A	0.4
-063-A22-SE12-06C	*	○	63	22	40	10.8	6	A	0.4
-080-A27-SE12-08		●	80	27	50	10.8	8	A	0.8
-080-A27-SE12-08C	*	○	80	27	50	10.8	8	A	0.8
-100-B32-SE12-10		●	100	32	50	10.8	10	B	1.2
-100-B32-SE12-10C	*	○	100	32	50	10.8	10	B	1.2
-125-B40-SE12-12		●	125	40	63	10.8	12	B	2.9
-125-B40-SE12-12C	*	○	125	40	63	10.8	12	B	2.9
-200-C60-SE12-16		●	200	60	63	10.8	16	C	6.1
-250-C60-SE12-18		●	250	60	63	10.8	18	C	10.9
-315-D60-SE12-24		●	315	60	63	10.8	24	D	21.6

● Ex stock / ab Lager ○ On demand / auf Anfrage * With internal cooling · Mit Innenkühlung

Applicable tool
Werkzeug **B11-B18**

Tools code key
Werkzeug ISO **B26-B27**

Grade selection guide
Sortenauswahl **B19-B23**

Technical data
Technische Daten **B236-B241**

Milling · Fräsen

Indexable Milling · Fräswendepplatten

Applicable inserts · Wendeschneidplatten

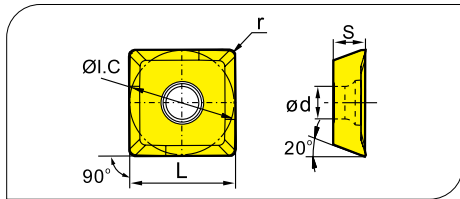

Workpiece Material Werkstoffe	Ideal Machining Condition Gute Bearbeitungsbedingungen			Normal Machining Condition Normale Bearbeitungsbedingungen			Unfavorable Machining Condition Ungünstige Bearbeitungsbedingungen		
	P	M	K	P	M	K	P	M	K
P Steel Stahl	●	●	●	●	●	●	●	●	●
M Stainless Steel Rostfreier Stahl	●	●	●	●	●	●	●	●	●
K Cast iron Gusseisen							●	●	●
N Non-ferrous material N-Metalle									●
S Heat-resistant steel Warmfester Stahl				●	●	●	●	●	●

Insert shape Plattenform	Type Typ	Dimension (mm) Abmessung					CVD Coating CVD Beschicht.						PVD Coating PVD Beschicht.					Cermet Cermet	Carbide uncoat. unbe. Hartmetall								
		L	I.C	S	d	r	YBC302	YBC301	YBC401	YBM253	YBM251	YBM351	YBD152	YBD252	YBG102	YB9320	YBG205			YBG202	YBG212	YBG302	YBG152	YBG252	YNG151	YNG151C	YC30S
	SEET09T308PER-PF	9.525	9.525	4.01	3.3	0.8												●									
	SEET09T308PER-PM	9.525	9.525	4.01	3.3	0.8						●						●									
	SEET09T308PER-PR	9.525	9.525	4.01	3.3	0.8						●							●								
	SEET120308PER-PF	13.308	13.308	4.04	4.1	0.8	●	●			●							●									
	SEET120308PER-PM	13.308	13.308	4.04	4.1	0.8	●			●	●	●	●	●				●		●							
	SEET120308PER-PR	13.308	13.308	4.04	4.1	0.8	●			●	●	●	●	○				●		●							
	SEET120308-LH	13.308	13.308	4.04	4.1	0.8								●												●	

Chipbreaker Selection FMP02 · Spanbrecher Auswahl FMP02

Application Anwendung	Finishing Schlichten	Semi-Finishing Mittlere Bearbeitung	Roughing Schruppen
P	PF 	PM 	PR
M			
K			
N	LH		

● Ex Stock / ab Lager ○ On demand / auf Anfrage

Features of **FMP02** series milling cutters Merkmale des Frässystems

High economical efficiency

Hohe wirtschaftliche Effizienz

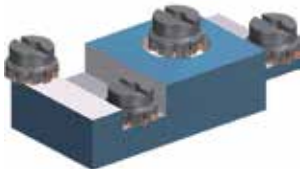

FMP02 series square shoulder mills can carry out a variety of cutting operations including face, vertical square shoulder, slot etc. Coarse pitch, fine pitch and extra fine pitch, each has a unique merit. Inserts' chipbreakers and grades are applied and optimized for a long tool life, they can achieve high efficiency machining in different condition. Each insert has 4 cutting edge, high economical efficiency.

Das universelle Frässystem FMP02 wird für unterschiedliche Fräsoperationen eingesetzt, z.B. Planfräsen, Eckfräsen, Nutenfräsen etc. Fräser mit weiter, enger und extraenger Teilung, Wendeschneidplatten in verschiedenen Sorten und Spanbrechern ermöglichen eine optimale Bearbeitung mit hoher Wirtschaftlichkeit; jede Wendeschneidplatte hat 4 Schneidkanten.

High productivity

Hohe Produktivität

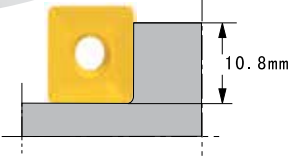

The major cutting edge is a α -curve, therefore the S Type inserts makes the tool obtain a ideal 90° approach angle while the minor cutting edge angle is enough. It ensures stable cutting operation. The maximum cutting depth can reach 10.8 mm, and the maximum feed rate can reach 0.3mm/z

Die Hauptschneide ist wellenförmig ausgebildet, erzielt einen idealen 90 Grad Einstellwinkel und eine stabile Bearbeitung. Die maximale Schnitttiefe beträgt 10,8 mm bei einem maximalen Vorschub von 0,3 mm/z.

Special structure design and fine manufacture make the tools possess very high precision, greatly improve the workpiece precision and surface quality.

Die spezielle Konstruktion und die präzise Herstellung der Schneidplatte garantieren eine verbesserte Genauigkeit und Oberfläche des Werkstückes.

High precision

Hohe Präzision

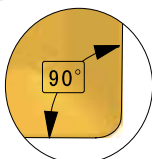

Large positive rake angle design makes cutting light and fast.

Großer positiver Spanwinkel für leichte und schnelle Bearbeitung.

Less cutting force

Geringe Schnittkräfte

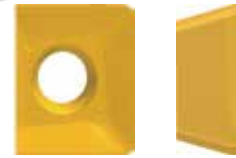

Simple screw clamping, inserts displacement is convenient. The chip pocket of rake face is big enough for smooth chip removal.

Durch die Schraubenklemmung ist einfacher Schneiden- bzw. Schneidplattenwechsel gegeben.

Easy & convenient to apply

Einfacher & schneller Schneidenwechsel

Adopting the carbide shim machined precisely to protect tool body, enable tool durable and long life.

Die präzise Hartmetall-Zwischenlage schützt den Fräskörper und bringt eine hohe Werkzeuglebensdauer.

High reliability

Hohe Werkzeugstabilität & Sicherheit



Milling · Fräsen

Indexable Milling Tools · Wendeplattenfräser

Recommended cutting data · Empfohlene Schnittdaten

Workpiece material Werkstückstoff	Hardness HB Härte	Grade Sorte	Cutting data Schnittdaten			
			V (m/min)	f (mm/z)		
				-PF	-PM	-PR
P Low-carbon steel Soft steel Niedriglegierter Kohlenstoffstahl Baustahl High-carbon steel Alloy steel Hochleg. Kohlenstoffstahl Leg. Stahl Alloy tool steel Leg. Werkzeugstahl	≤180	YBM251	270(220-350)	0.15(0.1-0.2)	0.2 (0.1-0.3)	0.3 (0.2-0.4)
		YBG202	270(200-360)	0.15(0.1-0.2)	0.2 (0.1-0.3)	0.3 (0.2-0.4)
		YBG302	230 (170-350)	0.15(0.1-0.2)	0.2 (0.1-0.3)	0.3 (0.2-0.4)
	180—280	YBM251	240 (200-320)	0.15(0.1-0.2)	0.2 (0.1-0.3)	0.3 (0.2-0.4)
		YBG202	240 (180-350)	0.15(0.1-0.2)	0.2 (0.1-0.3)	0.3 (0.2-0.4)
		YBG302	220 (150-330)	0.15(0.1-0.2)	0.2 (0.1-0.3)	0.3 (0.2-0.4)
	280—350	YBM251	220 (180-300)	0.1(0.1-0.2)	0.2 (0.1-0.3)	0.3 (0.2-0.4)
		YBG202	220 (170-340)	0.1(0.1-0.2)	0.2 (0.1-0.3)	0.3 (0.2-0.4)
		YBG302	190 (130-300)	0.15(0.1-0.2)	0.2 (0.1-0.3)	0.3 (0.2-0.4)
M Stainless steel Rostfreier Stahl	≤270	YBM251	150 (120-240)	0.1(0.1-0.2)	0.2 (0.1-0.3)	0.3 (0.2-0.4)
		YBG202	160 (110-270)	0.1(0.1-0.2)	0.2 (0.1-0.3)	0.3 (0.2-0.4)
		YBG302	140 (100-250)	0.15(0.1-0.2)	0.2 (0.1-0.3)	0.3 (0.2-0.4)
K Cast iron Gusseisen	180—250	YBG102	210 (120-300)	0.15(0.1-0.2)	0.2 (0.1-0.3)	0.3 (0.2-0.4)
		YBD152	240 (180-300)	0.15(0.1-0.2)	0.2 (0.1-0.3)	0.3 (0.2-0.4)
		YBD252	200 (150-250)	0.15(0.1-0.2)	0.2 (0.1-0.3)	0.3 (0.2-0.4)
				-LH		
N	Al alloy Leg. Alu	-	YD101	300-	0.15 (0.05-0.3)	

B

Milling Tools
Fräser



Case study for FMP02 Bearbeitungsbeispiel für FMP02



- Tool · Werkzeug: FMP02-100-B32-SE12-054
- Inserts · WSP: SEET120308PER-PM/YBD252

Workpiece material
Werkstoff: HT300/ GG30 (HB150)
Cooling system: dry cutting
Kühlsystem: trocken

Machine: vertical machining center
Maschine: vertikales Maschinen-Center

Cutting data
Schnittdaten:
 $V_c=200\text{m/min}$
 $a_p=3\text{mm}$
 $f_z=0.2\text{mm/z}$
 $a_e=80\text{mm}$

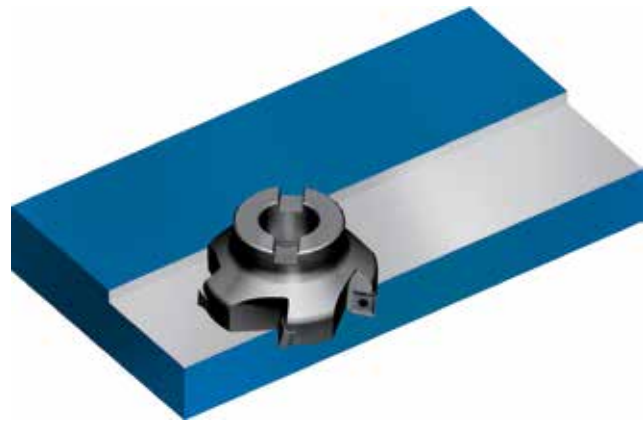

B

Milling Tools
Fräser

• Wear comparison of insert Verschleißvergleich der WSP

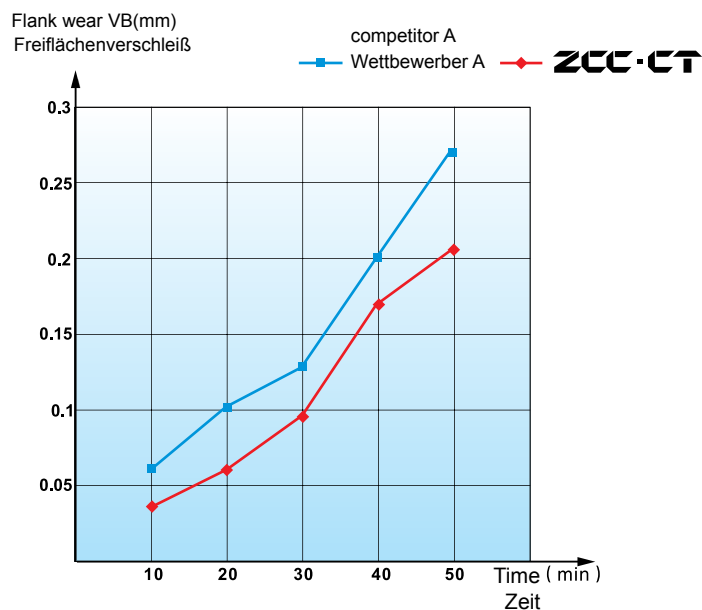

Milling · Fräsen

Indexable Milling Tools · Wendeplattenfräser

Face Milling Tools · Planfräser

Kr:89°



FMP03 P M K

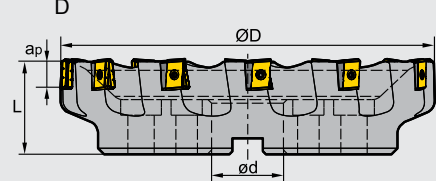
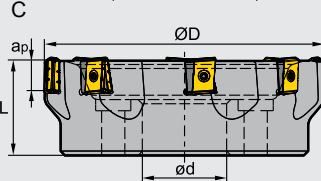
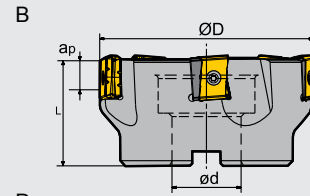
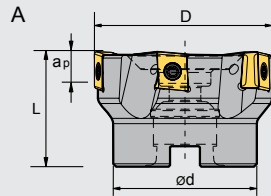

Type Typ	Stock Lager	R		Ø D	Ø d	L	apmax	No. of teeth Zähne	Insert WSP	Coupling Aufnahme	Weight Gewicht (kg)
		●	○								
FMP03 -050-A22-LN12-04C	*	●	○	50	22	40	7	4	LNKT120608-ZR	A	0.3
-050-A22-LN12-05C	*	○	○	50	22	40	7	5		A	0.3
-063-A22-LN12-05C	*	●	○	63	22	40	7	5		A	0.5
-063-A22-LN12-06C	*	○	○	63	22	40	7	6		A	0.5
-063-A27-LN12-05C	*	●		63	27	50	7	5		A	0.64
-063-A27-LN12-06C	*	●		63	27	50	7	6		A	0.65
-063-A27-LN12-07C	*	●		63	27	50	7	7		A	0.64
-080-A27-LN12-06C	*	●	○	80	27	50	7	6		A	1.0
-080-A27-LN12-07C	*	○	○	80	27	50	7	7	A	1.0	
-100-B32-LN12-06		○		100	32	50	7	6	LNKT1506EN-ZR	B	1.47
-125-B40-LN15-06		●	○	125	40	63	12	6		B	3.2
-160-C40-LN15-08		●	○	160	40	63	12	8		C	5.1
-160-C40-LN15-09		●		160	40	63	12	9		C	
-200-C60-LN15-10		●	○	200	60	70	12	10		C	7.5
-250-C60-LN15-12		○	○	250	60	70	12	12		C	12.2
-250-C60-LN15-13		○		250	60	70	12	13		C	
-315-D60-LN15-16		○	○	315	60	80	12	16		D	23.7
-125-B40-LN20-06		●	○	125	40	63	16	6	LNKT2007DN-ZR	B	3.3
-160-C40-LN20-08		●	○	160	40	63	16	8		C	5.3
-160-C40-LN20-09		●		160	40	63	16	9		C	
-200-C60-LN20-10		●	○	200	60	70	16	10		C	8.8
-200-C60-LN20-11		●		200	60	70	16	11		C	
-250-C60-LN20-12		●	○	250	60	70	16	12		C	14.0
-315-D60-LN20-15		○	○	315	60	80	16	15		D	23.9
-125-B40-LN25-05		●	○	125	40	63	20	5		LNKT2510-ZR	B
-160-C40-LN25-06		●	○	160	40	63	20	6	C		5.1
-200-C60-LN25-08		○	○	200	60	70	20	8	C		8.9
-250-C60-LN25-10		●	○	250	60	70	20	10	C		12.0
-315-D60-LN25-12		○	○	315	60	80	20	12	D		21.9

● Ex Stock / ab Lager ○ On demand / auf Anfrage * With internal cooling · Mit Innenkühlung

Spare Parts · Ersatzteile

Diameter Durchmesser Ø D	Insert Platte	shim Unterlage	Screw Schraube	Shim Screw Unterlagschraube	Wrench Schlüssel	Wrench Schlüssel	
Ø50 ~ Ø80	LN12	-	I60M4×12	-	WT15IS	-	
Ø125 ~ Ø315	LN15	LLN15-ZR	I60M4×12	I60M3×7	WT15IS	WT10IS	
Ø125 ~ Ø315	LN20	LLN20R-ZR	I60M4×15	I60M3×7	WT15IS	WT10IS	
Ø125 ~ Ø315	LN25	LLN25R-ZR	I60M5×17	I60M3.5×10.4	WT20IT	WT15IS	

Applicable inserts · Wendeschneidplatten

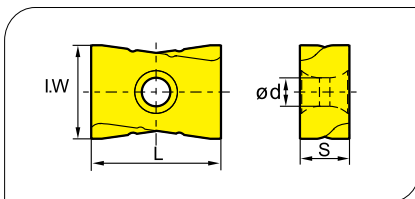

Workpiece Material Werkstoff	Ideal Machining Condition Gute Bearbeitungsbedingungen			Normal Machining Condition Normale Bearbeitungsbedingungen			Unfavorable Machining Condition Ungünstige Bearbeitungsbedingungen		
	P	M	K	P	M	K	P	M	K
P Steel Stahl	●	●	●	●	●	●	●	●	●
M Stainless Steel Rostfreier Stahl	●	●	●	●	●	●	●	●	●
K Cast iron Gusseisen							●	●	●
N Non-ferrite material Ne Metalle									
S Heat-resistant steel Warmfester Stahl							●	●	●

Insert shape Plattenform	Type Typ	Dimension (mm) Abmessung				CVD Coating CVD Beschicht.				PVD Coating PVD Beschicht.				Cermet Cermet	Carbide uncoat. unbe. Hartmetall														
		L	I.W	S	d	YBC302	YBC301	YBC401	YBM253	YBM251	YBM351	YBD152	YBD252			YBG102	YBG320	YBG205	YBG202	YBG212	YBG302	YBG152	YBG252	YNG151	YNG151C	YC30S	YD101	YD201	
	LNKT120608-ZR	12.7	12	6.35	4.3	●			●						●														
	LNKT1506EN-ZR	15.875	14	6.35	4.6		●			●	●	●							●										
	LNKT2007DN-ZR	20	17	7.94	4.6						●	●							●										
	LNKT2510-ZR	25	18	9.525	5.5							●	●						●										

Recommended cutting data · Empfohlene Schnittdaten

Workpiece material Werkstückstoff	Hardness HB Härte	Grade Sorte	Cutting data Schnittdaten	
			V (m/min)	f (mm/z)
P Low-carbon steel Soft steel Niedriglegierter Kohlenstoffstahl Baustahl	≤180	YBG302	180 (150-300)	0.5 (0.2-0.8)
		YBM351	180 (150-300)	0.5 (0.2-0.8)
	180-280	YBG302	150 (120-280)	0.5 (0.2-0.8)
		YBM351	140 (120-280)	0.5 (0.2-0.8)
Alloy tool steel Leg. Werkzeugstahl	280-350	YBG302	120 (80-250)	0.45 (0.2-0.6)
		YBM351	100 (80-250)	0.45 (0.2-0.6)
M Stainless steel Rostfreier Stahl	≤270	YBG302	120 (80-200)	0.45 (0.2-0.6)
		YBM351	100 (80-200)	0.45 (0.2-0.6)
K Cast iron Gusseisen	180-250	YBD152	150 (120-200)	0.3 (0.2-0.5)
		YBD252	130 (110-200)	0.3 (0.2-0.5)

Applicable tool
Werkzeug **B11-B18**

Tools code key
Werkzeug ISO **B26-B27**

Grade selection guide
Sortenauswahl **B19-B23**

Technical data
Technische Daten **B236-B241**

Face Milling Tools · Planfräser



FMR01 **P** **M** **K**

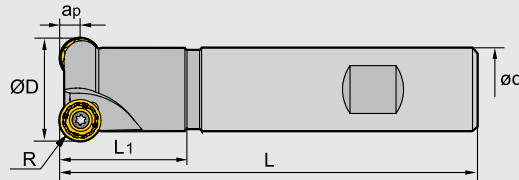

Specification of tools · Werkzeug Beschreibung

Type Typ	* *	Stock Lager	Dimension (mm) Abmessung						No. of teeth Zähne	Weight Gewicht (kg)
			Ø D	Ø d	L	L1	R	apmax		
FMR01 -025-XP20-RC10-02		●	25	20	100	30	5	5	2	0.2
-025-XP20-RC10-02C	*	●	25	20	100	30	5	5	2	0.2
-032-XP25-RC10-02		●	32	25	120	35	5	5	2	0.5
-032-XP25-RC10-02C	*	●	32	25	120	35	5	5	2	0.5
-040-XP32-RC12-03		●	40	32	120	40	6	6	3	0.7
-040-XP32-RC12-03C	*	●	40	32	120	40	6	6	3	0.7
-050-XP32-RC12-03		●	50	32	120	40	6	6	3	0.8
-050-XP32-RC12-03C	*	●	50	32	120	40	6	6	3	0.8

Spare Parts · Ersatzteile

Diameter Durchmesser Ø D	Screw Schraube	Wrench Schlüssel
Ø25 - Ø32	I60M4×8.4	WT15S
Ø40 - Ø50	I60M3.5×10	



● Ex Stock / ab Lager ○ On demand / auf Anfrage * With internal cooling · Mit Innenkühlung

Applicable inserts · Wendeschneidplatten

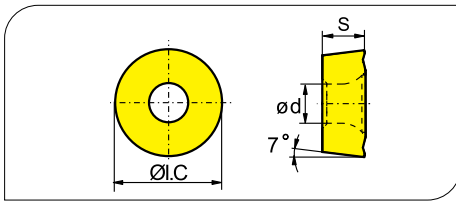

● Ideal Machining Condition / Gute Bearbeitungsbedingungen
● Normal Machining Condition / Normale Bearbeitungsbedingungen
● Unfavorable Machining Condition / Ungünstige Bearbeitungsbedingungen

Workpiece Material / Werkstoff	P	M	K	N	S	Steel / Stahl	Stainless Steel / Rostfreier Stahl	Cast iron / Gusseisen	Non-ferrous material / Nichtmetalle	Heat-resistant steel / Warmfester Stahl
P	●	●	●	●	●	●	●	●	●	●
M	●	●	●	●	●	●	●	●	●	●
K	●	●	●	●	●	●	●	●	●	●
N	●	●	●	●	●	●	●	●	●	●
S	●	●	●	●	●	●	●	●	●	●

Insert shape / Plattenform	Type / Typ	Dimension (mm) / Abmessung			CVD Coating / CVD Beschicht.						PVD Coating / PVD Beschicht.				Cermets / Cermet	Carbide uncoat. / unbe. Hartmetall									
		I.C	S	d	YBC302	YBC301	YBC401	YBM253	YBM251	YBM351	YBD152	YBD252	YBG102	YB9320			YBG205	YBG202	YBG212	YBG302	YBG152	YBG252	YNG151	YNG151C	YC30S
	RCKT10T3MO-DM	10.0	3.97	4.4	●	●										●									
	RCKT1204MO-DM	12.0	4.76	4.0	●	●		●	●	●						●		●							
	RCKT1204MO-DR	12.0	4.76	4.0	●	●		●	●							●		●							
	RCKT1204MO-ER	12.0	4.76	4.0				●																	
	RCGX1204MO-LH	12.0	4.76	4.0																				●	
	RCKT1204MO-NM	12.0	4.76	4.0				●										●							

Recommended cutting data · Empfohlene Schnittdaten

Workpiece material / Werkstückstoff	Hardness HB / Härte	Grade / Sorte	Cutting data · Schnittdaten			
			V (m/min)	f (mm/z)		
				-DM	-DR	
P Low-carbon steel / Soft steel / Niedriglegierter Kohlenstoffstahl / Baustahl	≤180	YBM251 / YBC301	270 (220-350)	0.2(0.1-0.5)	0.3 (0.2-0.8)	
		YBM351 / YBC401	220 (180-300)	0.25(0.1-0.5)	0.3 (0.2-0.8)	
		YBG202	270 (200-360)	0.2(0.1-0.5)	0.3 (0.2-0.8)	
	High-carbon steel / Alloy steel / Hochleg. Kohlenstoffstahl / Leg. Stahl	180-280	YBM251 / YBM253	240 (200-320)	0.2(0.1-0.5)	0.3 (0.2-0.8)
			YBC301			
			YBM351 / YBC401	200 (160-280)	0.25(0.1-0.5)	0.3 (0.2-0.8)
			YBG202	240 (180-350)	0.2(0.1-0.5)	0.3 (0.2-0.8)
	Alloy tool steel / Leg. Werkzeugstahl	280-350	YBM251 / YBM253	220 (180-300)	0.2(0.1-0.4)	0.3 (0.2-0.6)
			YBC301			
			YBM351 / YBC401	180 (150-250)	0.2(0.1-0.5)	0.3 (0.2-0.8)
			YBG202	220 (170-340)	0.2(0.1-0.4)	0.3 (0.2-0.6)
	M Stainless steel / Rostfreier Stahl	≤270	YBM251 / YBM253	150 (120-240)	0.2(0.1-0.4)	0.3 (0.2-0.6)
YBM351 / YBC401			150 (100-220)	0.2(0.1-0.4)	0.3 (0.2-0.6)	
YBG202			160 (110-270)	0.2(0.1-0.4)	0.3 (0.2-0.6)	
K Cast iron / Gusseisen	180-250	YBD152	210 (120-300)	0.2(0.1-0.5)	0.3 (0.2-0.8)	

Applicable tool / Werkzeug **B11-B18**

Tools code key / Werkzeug ISO **B26-B27**

Grade selection guide / Sortenauswahl **B19-B23**

Technical data / Technische Daten **B236-B241**

Milling · Fräsen

Indexable Milling Tools · Wendeplattenfräser

Case study for FMR01 Bearbeitungsbeispiel für FMR01

Workpiece material
Werkstoff: 42CrMo (HRC35)
Cooling system: dry cutting
Kühlsystem: trocken

Machine: vertical machining center
Maschine: vertikales Maschinen-Center

Cutting data
Schnittdaten:
 $V_c=200\text{m/min}$
 $a_p=3\text{mm}$
 $f_z=0.2\text{mm/z}$



- Tool · Werkzeug: FMR01-025-XP20-RC10-02
- Inserts · WSP: RCKT10T3MO-DM/YBG202



• Wear comparison of insert Verschleißvergleich der WSP

ZCC-CT



22 minutes later

Competitor A
Wettbewerber A



22 minutes later

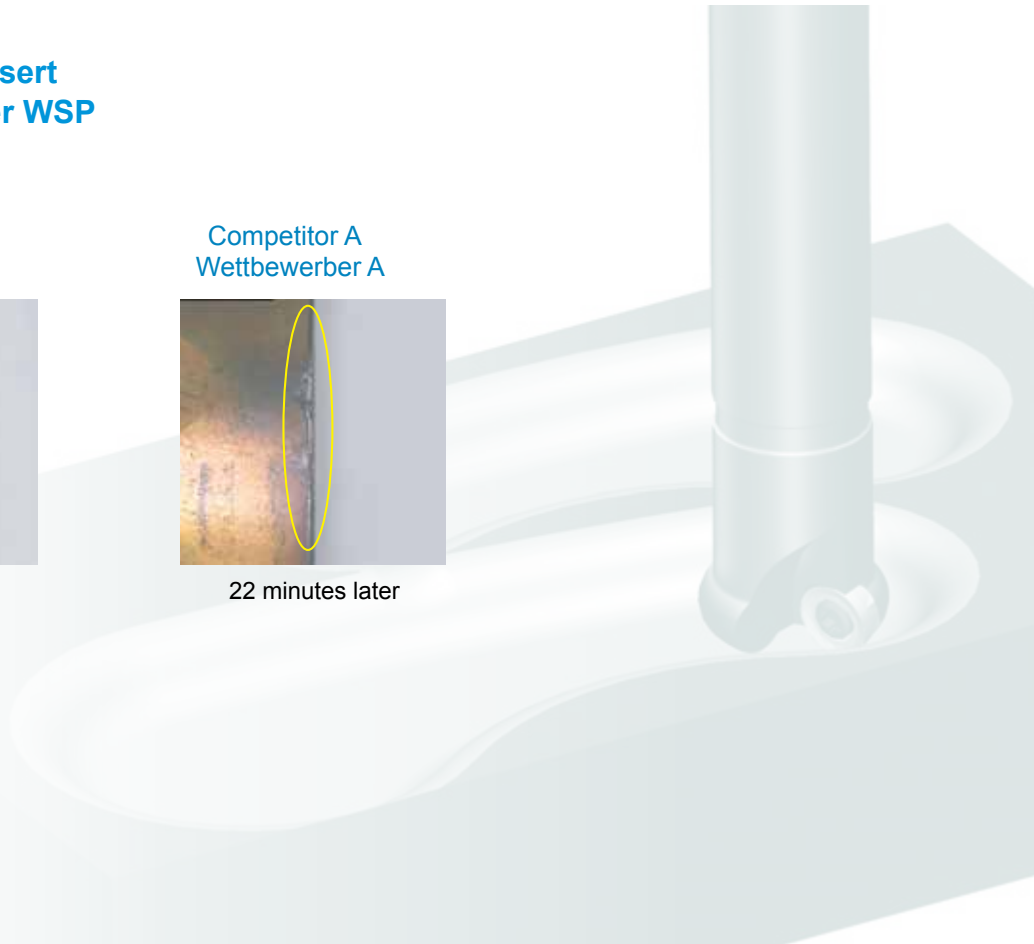

B
Milling Tools
Fräser

Face Milling Tools · Planfräser



FMR02 **P** **M** **K**

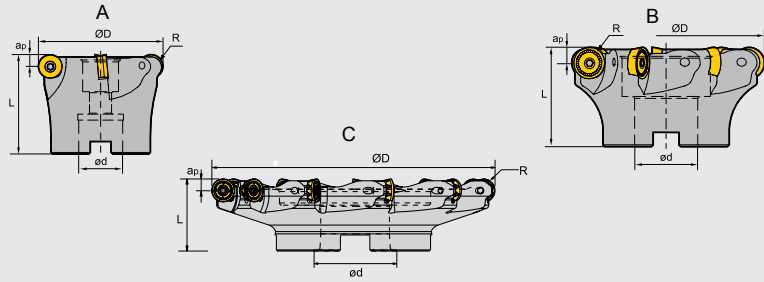

Specification of tools · Werkzeug Beschreibung

Type Typ	✱	Stock Lager	Dimension (mm) Abmessung					No. of teeth Zähne	Coupling Aufnahme	Weight Gewicht (kg)
			Ø D	Ø d	L	R	apmax			
FMR02 050-A22-RC12-05C	✱	●	50	22	40	6	6	5	A	0.7
052-A22-RC12-05C	✱	●	52	22	40	6	6	5	A	0.7
063-A22-RC12-04		●	63	22	40	6	6	4	A	0.7
063-A22-RC12-04C	✱	●	63	22	40	6	6	4	A	0.7
063-A22-RC12-06		●	63	22	40	6	6	4	A	0.7
063-A22-RC12-06C	✱	●	63	22	40	6	6	6	A	0.7
080-A27-RC12-07C	✱	●	80	27	50	6	6	7	B	0.7
100-B32-RC12-08C	✱	●	100	32	50	6	6	8	B	0.89
063-A22-RC16-04		●	63	22	40	8	8	4	A	0.7
063-A22-RC16-04C	✱	●	63	22	40	8	8	4	A	0.7
066-A27-RC16-05C	✱	●	66	27	50	8	8	4	A	0.5
080-B27-RC16-05		●	80	27	50	8	8	5	B	0.7
080-B27-RC16-05C	✱	○	80	27	50	8	8	5	B	0.7
080-B27-RC16-07		●	80	27	50	8	8	7	B	0.7
100-B32-RC16-06		●	100	32	63	8	8	6	B	1.2
100-B32-RC16-06C	✱	●	100	32	63	8	8	6	B	1.2
125-B40-RC16-07		●	125	40	63	8	8	7	B	2.5
160-B40-RC16-10(FB)		●	160	40	63	8	8	10	B	3.94
200-C60-RC16-12FB		●	200	60	63	8	8	12	C	5.4
080-A27-RC20-04		●	80	27	50	10	10	4	A	0.7
080-A27-RC20-04C	✱	●	80	27	50	10	10	4	A	0.7
100-B32-RC20-05		●	100	32	63	10	10	5	B	1.2
100-B32-RC20-05C	✱	●	100	32	63	10	10	5	B	1.2
100-B32-RC20-06		●	100	32	63	10	10	6	B	1.2
100-B32-RC20-06C	✱	●	100	32	63	10	10	6	B	1.2
125-B40-RC20-06		●	125	40	63	10	10	6	B	1.2
125-B40-RC20-06C	✱	●	125	40	63	10	10	6	B	1.2
125-B40-RC20-07		●	125	40	63	10	10	7	B	2.2
125-B40-RC20-07C	✱	●	125	40	63	10	10	7	B	2.2
160-B40-RC20-08		●	160	40	63	10	10	8	B	4.2
160-B40-RC20-08C	✱	○	160	40	63	10	10	8	B	4.2
200-B40-RC20-12		●	200	40	63	10	10	12	B	5.85
250-C60-RC20-10		●	250	60	63	10	10	10	C	8.49
250-C60-RC20-11		○	250	60	63	10	10	11	C	8.37

● Ex stock / ab Lager ○ On demand / auf Anfrage ✱ With internal cooling · Mit Innenkühlung

Applicable tool
Werkzeug **B11-B18**

Tools code key
Werkzeug ISO **B26-B27**



Grade selection guide
Sortenauswahl **B19-B23**

Technical data
Technische Daten **B236-B241**

Milling · Fräsen

Indexable Milling Tools · Wendepplattenfräser

Spare Parts · Ersatzteile

Diameter Durchmesser Ø D	Insert WSP	Screw Schraube	Wrench Schlüssel	
				
Ø63-Ø80	RC12	I60M3.5×10	WT15IS	--
Ø63 -Ø100	RC16	I60M5×13	--	WT20IT
Ø80 -Ø250	RC20	I43M6×16	--	WT25IT





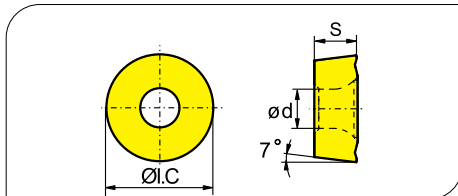

Coupling Aufnahme	Diameter Durchmesser Ø D	Screw-Schraube	Ring-Dichtring
B27	Ø80	LDB27C	B27-002-CP
B32	Ø100	LDB32C	B32-002-CP
B40	Ø125	LDB40C	B40-002-CP
B40	Ø160	LDB40C	B40-003-CP

Applicable inserts · Wendeschneidplatten



Workpiece Material Werkstoffe	Ideal Machining Condition Gute Bearbeitungsbedingungen			Normal Machining Condition Normale Bearbeitungsbedingungen			Unfavorable Machining Condition Ungünstige Bearbeitungsbedingungen		
	P	M	K	N	S				
P Steel Stahl	●	●	●	●	●	●	●	●	●
M Stainless Steel Rostfreier Stahl	●	●	●	●	●	●	●	●	●
K Cast iron Gusseisen						●	●	●	●
N Non-ferite material Ne Metalle									●
S Heat-resistant steel Warmfester Stahl						●	●	●	●

Insert shape Plattenform	Type Typ	Dimension (mm) Abmessung			CVD Coating CVD Beschicht.						PVD Coating PVD Beschicht.						Cermet Cermet	Carbide uncoat. unbe. Hartmetall									
		I.C	S	d	YBC302	YBC301	YBC401	YBM253	YBM251	YBM351	YBD152	YBD252	YBG102	YB9320	YBG205	YBG202			YBG212	YBG302	YBG152	YBG252	YNG151	YNG151C	YC30S	YD101	YD201
					●	●	●	●	●	●	●	●	●	●	●	●			●	●	●	●	●	●	●	●	●
	RCKT1204MO-DM	12.0	4.76	4.0	●	●	●	●	●	●	●				●		●										
	RCKT1606MO-DM	16.0	6.35	5.56	●	●	●	●	●	●	●			●			●										
	RCKT2006MO-DM	20.0	6.35	6.55	●	●	●	●	●	●	●																
	RCKT1204MO-DR	12.0	4.76	4.0	●	●	●	●	●	●	●			●	●												
	RCKT1606MO-DR	16.0	6.35	5.56	●	●	●	●	●	●	●		●		●												
	RCKT2006MO-DR	20.0	6.35	6.55	●	●	●	●	●	●	●				●		●										
	RCKT1204MO-ER	12.0	4.76	4.0				●																			
	RCKT1606MO-ER	16.0	6.35	5.56				●																			
	RCKT2006MO-ER	20.0	6.35	6.55				●																			
	RCKT1204MO-NM	12.0	4.76	4.0				●									●										
	RCKT1606MO-NM	16.0	6.35	5.56													●										

● Ex Stock / ab Lager ○ On demand / auf Anfrage

Applicable inserts · Wendeschneidplatten

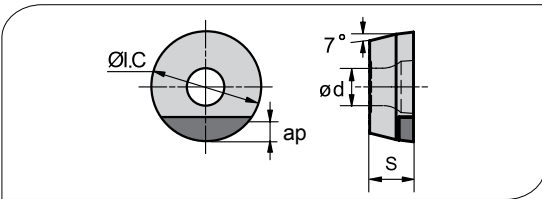

● Continuous cutting
Vollschnitt

⊗ Continuous and light interrupted cutting
Voll und leicht unterbrochener Schnitt

⊗ Interrupted cutting
Stark unterbrochener Schnitt

Workpiece Material Werkstoff	H	Workpiece Material			
		●	⊗	⊗	●
H Hardened material Gehärteter Werkstoff					
K Cast iron Gusseisen					●
N Non-ferrous material Nichte Metalle					

Insert shape Plattenform	Type Typ	Dimension (mm) Abmessung				CBN			
		I.C	S	d	apmax	YCB111	YCB121	YCB131	YCB211
	RCMW1204MO-PCBN	12.0	4.76	4.1	2.7				○

Recommended cutting data · Empfohlene Schnittdaten

Workpiece material Werkstückstoff	Hardness HB Härte	Grade Sorte	Cutting data · Schnittdaten			
			V (m/min)	f (mm/z)		
				-DM	-DR	
P Low-carbon steel Soft steel Niedriglegierter Kohlenstoffstahl Baustahl	≤180	YBM251 YBC301	270 (220-350)	0.2(0.1-0.5)	0.3 (0.2-0.8)	
		YBM351 YBC401	220 (180-300)	0.25(0.1-0.5)	0.3 (0.2-0.8)	
		YBG202	270 (200-360)	0.2(0.1-0.5)	0.3 (0.2-0.8)	
	High-carbon steel Alloy steel Hochleg. Kohlenstoffstahl	180-280	YBM251 YBC301	240 (200-320)	0.2(0.1-0.5)	0.3 (0.2-0.8)
			YBM351 YBC401	200 (160-280)	0.25(0.1-0.5)	0.3 (0.2-0.8)
			YBG202	240 (180-350)	0.2(0.1-0.5)	0.3 (0.2-0.8)
Alloy tool steel Leg. Werkzeugstahl	280-350	YBM251 YBC301	220 (180-300)	0.2(0.1-0.4)	0.3 (0.2-0.6)	
		YBM351 YBC401	180 (150-250)	0.2(0.1-0.5)	0.3 (0.2-0.8)	
		YBG202	220 (170-340)	0.2(0.1-0.4)	0.3 (0.2-0.6)	
M Stainless steel Rostfreier Stahl	≤270	YBM251 YBM253	150 (120-240)	0.2(0.1-0.4)	0.3 (0.2-0.6)	
		YBM351 YBC401	150 (100-220)	0.2(0.1-0.4)	0.3 (0.2-0.6)	
		YBG202	160 (110-270)	0.2(0.1-0.4)	0.3 (0.2-0.6)	
K Cast iron Gusseisen	180-250	YBD152	210 (120-300)	0.2(0.1-0.5)	0.3 (0.2-0.8)	

Applicable tool
Werkzeug **B11-B18**

Tools code key
Werkzeug ISO **B26-B27**

Grade selection guide
Sortenauswahl **B19-B23**

Technical data
Technische Daten **B236-B241**

Face Milling Tools · Planfräser





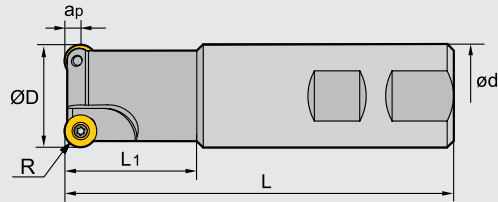

FMR03 P M K



■ Specification of tools · Werkzeug Beschreibung

Type Typ	*	Stock Lager	Dimension (mm) Abmessung				No. of teeth Zähne	Weight Gewicht (kg)		
			Ø D	Ø d	L	L ₁			R	ap _{max}
FMR03 -016-XP16-RD08-02		●	16	16	100	25	4	4	2	0.1
-016-XP16-RD08-02C	*	○	16	16	100	25	4	4	2	0.1
-025-XP25-RD08-02		●	25	25	100	30	4	4	2	0.3
-025-XP25-RD08-02C	*	●	25	25	100	30	4	4	2	0.3
-032-XP32-RD10-02		●	32	32	120	40	5	5	2	0.7
-032-XP32-RD10-02C	*	●	32	32	120	40	5	5	2	0.7
-040-XP32-RD12-03		●	40	32	120	40	6	6	3	0.7
-040-XP32-RD12-03C	*	●	40	32	120	40	6	6	3	0.7
-050-XP32-RD12-04		●	50	32	120	40	6	6	4	0.8
-050-XP32-RD12-04C	*	●	50	32	120	40	6	6	4	0.8

■ Spare Parts · Ersatzteile

Diameter Durchmesser Ø D	Screw Schraube	Wrench Schlüssel
Ø25	 I60M3×7	 WT09IP
Ø32-Ø50	 I60M4×10	 WT15IP

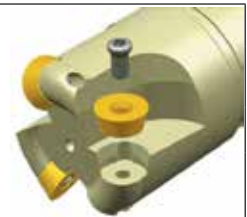

● Ex Stock / ab Lager ○ On demand / auf Anfrage * With internal cooling · Mit Innenkühlung

Applicable inserts · Wendeschneidplatten

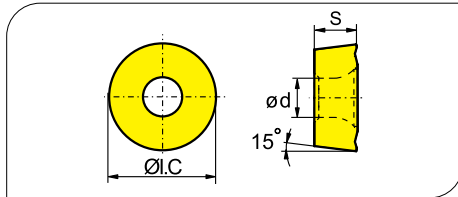

Workpiece Material Werkstoffe	Ideal Machining Condition Gute Bearbeitungsbedingungen			Normal Machining Condition Normale Bearbeitungsbedingungen			Unfavorable Machining Condition Ungünstige Bearbeitungsbedingungen		
	P	M	K	P	M	K	P	M	K
P Steel Stahl	●	●	●	●	●	●	●	●	●
M Stainless Steel Rostfreier Stahl	●	●	●	●	●	●	●	●	●
K Cast iron Gusseisen	●	●	●	●	●	●	●	●	●
N Non-ferrous material Nichtmetalle	●	●	●	●	●	●	●	●	●
S Heat-resistant steel Wärmebeständiger Stahl	●	●	●	●	●	●	●	●	●

Insert shape Plattenform	Type Typ	Dimension (mm) Abmessung			CVD Coating CVD Beschicht.						PVD Coating PVD Beschicht.						Cermet Cemet	Carbide uncoat. unbe. Hartmetall								
		I.C	S	d	YBC302	YBC301	YBC401	YBM253	YBM251	YBM351	YBD152	YBD252	YBG102	YB9320	YBG205	YBG202			YBG212	YBG302	YBG152	YBG252	YNG151	YNG151C	YC30S	YD101
	RDKW0803MO	8.0	3.18	3.4						●																
	RDKW10T3MO	10.0	3.97	4.4	●	●				○			●			●										
	RDKW1204MO	12.0	4.76	4.4	●					●	●			●	●	●	●		●							

B

Milling Tools
Fräser

Applicable tool
Werkzeug **B11-B18**

Tools code key
Werkzeug ISO **B26-B27**

Grade selection guide
Sortenauswahl **B19-B23**

Technical data
Technische Daten **B236-B241**

Face Milling Tools · Planfräser

FMR03 **P** **M** **K**

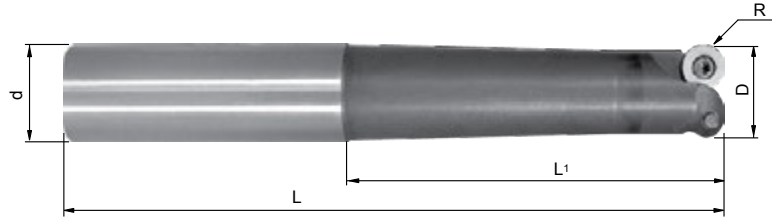

Type Typ	*	Stock Lager	Dimension (mm) Abmessung						No. of teeth Zähne
			Ø D	Ø d	L	L ₁	R	a _{pmax}	
FMR03 -015-G16-XS RD0702-02		●	15	16	88	40	3.5	3.5	2
-015-G16-XS RD0702-02C	*	○	15	16	88	40	3.5	3.5	2
-015-G16-S RD0702-02		●	15	16	108	60	3.5	3.5	2
-015-G16-S RD0702-02C	*	○	15	16	108	60	3.5	3.5	2
-015-G20-M RD0702-02		●	15	20	130	80	3.5	3.5	2
-015-G20-M RD0702-02C	*	○	15	20	130	80	3.5	3.5	2
-015-G20-L RD0702-02		○	15	20	150	100	3.5	3.5	2
-015-G20-L RD0702-02C	*	○	15	20	150	100	3.5	3.5	2
-015-G25-XL RD0702-02		●	15	25	120	176	3.5	3.5	2
-015-G25-XL RD0702-02C	*	○	15	25	120	176	3.5	3.5	2
-020-G20-XS RD1003-02		○	20	20	90	40	5	5	2
-020-G20-XS RD1003-02C	*	○	20	20	90	40	5	5	2
-020-G20-S RD1003-02		●	20	20	110	60	5	5	2
-020-G20-S RD1003-02C	*	○	20	20	110	60	5	5	2
-020-G25-M RD1003-02		●	20	25	136	80	5	5	2
-020-G25-M RD1003-02C	*	○	20	25	136	80	5	5	2
-020-G25-L RD1003-02		●	20	25	156	100	5	5	2
-020-G25-L RD1003-02C	*	○	20	25	156	100	5	5	2
-020-G25-XL RD1003-02		●	20	25	176	120	5	5	2
-020-G25-XL RD1003-02C	*	○	20	25	176	120	5	5	2

Inserts · WSP: RDKW0702MO**/ RDKW1003MO**

■ Spare Parts · Ersatzteile

Type Typ	Screw Schraube	Wrench Schlüssel	
FMR03**RD0702	 I60M2,5 x 5,0	 WT07P	
FMR03**RD1003	 I60M3,5 x 7,7	 WT15P	

● Ex Stock / ab Lager ○ On demand / auf Anfrage * With internal cooling · Mit Innenkühlung

Applicable inserts · Wendeschneidplatten

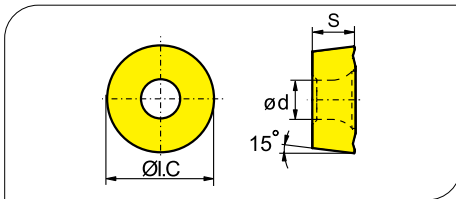

Workpiece Material Werkstoffe	Ideal Machining Condition Gute Bearbeitungsbedingungen			Normal Machining Condition Normale Bearbeitungsbedingungen			Unfavorable Machining Condition Ungünstige Bearbeitungsbedingungen		
	P	M	K	P	M	K	P	M	K
Steel Stahl	●	●	●	●	●	●	●	●	●
Stainless Steel Rostfreier Stahl	●	●	●	●	●	●	●	●	●
Cast iron Gusseisen	●	●	●	●	●	●	●	●	●
Non-ferrous material Nichtmetalle	●	●	●	●	●	●	●	●	●
Heat-resistant steel Wärmefester Stahl	●	●	●	●	●	●	●	●	●

Insert shape Plattenform	Type Typ	Dimension (mm) Abmessung			CVD Coating CVD Beschicht.						PVD Coating PVD Beschicht.				Cermet Cermet	Carbide uncoat. unbe. Hartmetall									
		I.C	S	d	YBC302	YBC301	YBC401	YBM253	YBM251	YBM351	YBD152	YBD252	YBG102	YB9320			YBG205	YBG202	YBG212	YBG302	YBG152	YBG252	YNG151	YNG151C	YC30S
	RDKW0702MO-1	7.0	2.38	2.7						●															
	RDKW0702MO-2	7.0	2.38	2.7									●												
	RDKW1003MO-1	10.0	3.18	3.9					●	●					●	●	●								
	RDKW1003MO-2	10.0	3.18	3.9									●												
	RDKW1003MO-3	10.0	3.18	3.9				●									●								

B

Milling Tools
Fräser

Recommended cutting data · Empfohlene Schnittdaten

Workpiece material Werkstückstoff	Hardness HB Härte	Grade Sorte	Cutting data · Schnittdaten	
			V (m/min)	f (mm/z)
P Low-carbon steel Soft steel Niedriglegierter Kohlenstoffstahl Baustahl	≤180	YBM251	270 (220-350)	0.2 (0.08-0.45)
		YBC301		
		YBM351	220 (180-300)	0.25 (0.15-0.45)
	YBG302			
	180-280	YBM251	240 (200-320)	0.2 (0.08-0.45)
		YBC301		
		YBM351	200 (160-280)	0.25 (0.15-0.45)
	YBG302			
	280-350	YBM251	240 (180-350)	0.2 (0.1-0.45)
YBC301				
YBM351		220 (170-340)	0.2 (0.1-0.45)	
YBG302				
M Stainless steel Rostfreier Stahl	≤270	YBM251	150 (120-240)	0.2 (0.08-0.45)
		YBM351		
		YBG302	150 (100-220)	0.25 (0.1-0.45)
	YBG202			
	180-250	YBM251	160 (110-270)	0.2 (0.1-0.45)
		YBM351		
YBG302		210 (120-300)	0.2 (0.1-0.45)	
YBG102				

Applicable tool
Werkzeug **B11-B18**

Tools code key
Werkzeug ISO **B26-B27**

Grade selection guide
Sortenauswahl **B19-B23**

Technical data
Technische Daten **B236-B241**

Face Milling Tools · Planfräser



FMR04 **P** **M** **K**

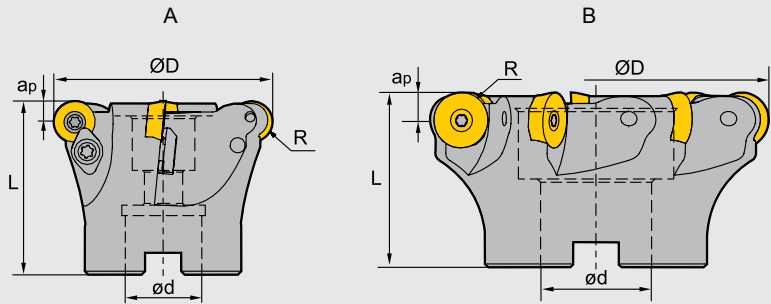

Specification of tools · Werkzeug Beschreibung

Type Typ	* Stock Lager	Dimension (mm) Abmessung					No. of teeth Zähne	Coupling Aufnahme	Weight Gewicht (kg)
		Ø D	Ø d	L	R	apmax			
FMR04 050-A22-RD12-03	●	50	22	40	6	6	3	A	0.3
050-A22-RD12-03C	* ●	50	22	40	6	6	3	A	0.3
063-A22-RD12-04	●	63	22	50	6	6	4	A	0.5
063-A22-RD12-04C	* ●	63	22	50	6	6	4	A	0.5
080-B27-RD16-05	●	80	27	50	8	8	5	B	1.2
080-B27-RD16-05C	* ●	80	27	50	8	8	5	B	1.2
100-B32-RD16-06	●	100	32	50	8	8	6	B	1.0
100-B32-RD16-06C	* ●	100	32	50	8	8	6	B	1.0
125-B40-RD20-06	○	125	40	63	10	10	6	B	1.9
125-B40-RD20-06C	* ○	125	40	63	10	10	6	B	1.9
160-B40-RD20-07	○	160	40	63	10	10	7	B	3.7
160-B40-RD20-07C	* ○	160	40	63	10	10	7	B	3.7

Spare Parts · Ersatzteile

Diameter Durchmesser Ø D	Screw Schraube	Clamp Pratze	Clamp Screw Schraube (Pratze)	Wrench Schlüssel	
	Ø50-Ø80				
Ø63 -Ø125	I60M3.5×10	WD-204	I60M4×10	WT15IP	--
Ø125 -Ø160	I60M5×13	WD-207	I60M5×13	--	WT20IT
	I43M6×16	--	--	--	WT25IT

Coupling Aufnahme	Diameter Durchmesser Ø D	Screw-Schraube	Ring-Dichtring
B27	Ø80	LDB27C	B27-002-CP
B32	Ø100	LDB32C	B32-002-CP
B40	Ø125	LDB40C	B40-002-CP
B40	Ø160	LDB40C	B40-003-CP

● Ex Stock / ab Lager ○ On demand / auf Anfrage * With internal cooling · Mit Innenkühlung

Applicable inserts · Wendeschneidplatten

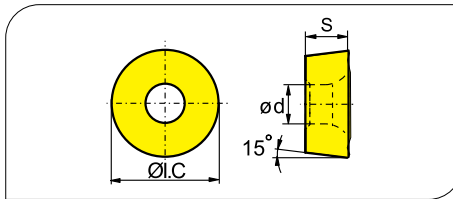

Workpiece Material Werkstoffe	Ideal Machining Condition Gute Bearbeitungsbedingungen			Normal Machining Condition Normale Bearbeitungsbedingungen			Unfavorable Machining Condition Ungünstige Bearbeitungsbedingungen		
	P	M	K	P	M	K	P	M	K
P Steel Stahl	●	●	●	●	●	●	●	●	●
M Stainless Steel Rostfreier Stahl	●	●	●	●	●	●	●	●	●
K Cast iron Gusseisen			●			●			●
N Non-ferrous material Ne Metalle									●
S Heat-resistant steel Wärmefester Stahl				●	●		●	●	

Insert shape Plattenform	Type Typ	Dimension (mm) Abmessung			CVD Coating CVD Beschicht.						PVD Coating PVD Beschicht.				Cermets Cermet	Carbide uncoat. unbe. Hartmetall										
		I.C	S	d	YBC302	YBC301	YBC401	YBM253	YBM251	YBM351	YBD152	YBD252	YBG102	YB9320			YBG205	YBG202	YBG212	YBG302	YBG152	YBG252	YNG151	YNG151C	YC30S	YD101
	RDKW1204MO	12.0	4.76	4.4	●				●	●			●	●	●	●		●								
	RDKW1605MO	16.0	5.56	5.5						●						●										
	RDKW2006MO	20.0	6.35	6.5	●					●		●														
	RDKW2006MO-3	20.0	6.35	6.5												●										

B

Milling Tools
Fräser

Applicable tool
Werkzeug **B11-B18**

Tools code key
Werkzeug ISO **B26-B27**

Grade selection guide
Sortenauswahl **B19-B23**

Technical data
Technische Daten **B236-B241**

Milling · Fräsen

Indexable Milling Tools · Wendepplattenfräser

Face Milling Tools · Planfräser



FMR04 **P** **M** **K**

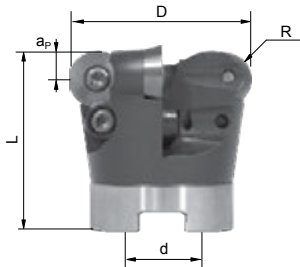

Type Typ	Stock Lager	Dimension (mm) Abmessung					No. of teeth Zähne
		Ø D	Ø d	L	R	a _p max	
FMR04 042-A16-RD1003-06	●	42	16	44	5	5	6
042-A16-RD1003-06C	* ●	42	16	44	5	5	6
052-A22-RD1003-06	●	52	22	50	5	5	6
052-A22-RD1003-07	●	52	22	50	5	5	7
052-A22-RD1003-07C	* ●	52	22	50	5	5	7
042-A16-RD12T3-05	●	42	16	42	6	6	5
042-A16-RD12T3-05C	* ●	42	16	42	6	6	5
052-A22-RD12T3-05	●	52	22	50	6	6	5
052-A22-RD12T3-05C	* ●	52	22	50	6	6	5
066-A27-RD12T3-06	●	66	27	50	6	6	6
066-A27-RD12T3-06C	* ●	66	27	50	6	6	6
080-A27-RD12T3-07	●	80	27	50	6	6	7
080-A27-RD12T3-07C	* ●	80	27	50	6	6	7
*052-A22-RD1604-04	●	52	22	50	8	8	4
*052-A22-RD1604-04C	* ●	52	22	50	8	8	4
*052-A22-RD1604-05	○	52	22	50	8	8	5
*052-A22-RD1604-05C	* ●	52	22	50	8	8	5
066-A27-RD1604-05	●	66	27	50	8	8	5
066-A27-RD1604-05C	* ●	66	27	50	8	8	5
080-A27-RD1604-06	●	80	27	52	8	8	6
080-A27-RD1604-06C	* ●	80	27	52	8	8	6
100-B32-RD1604-07	●	100	32	52	8	8	7
100-B32-RD1604-07C	* ●	100	32	52	8	8	7
125-B40-RD1604-08	●	125	40	52	8	8	8
125-B40-RD1604-08C	* ●	125	40	52	8	8	8
160-B40-RD1604-09	●	160	40	52	8	8	9
160-B40-RD1604-09C	* ●	160	40	52	8	8	9

Spare Parts · Ersatzteile

* = WX16N (außer für FMP04-052) (except for FMP04-052)

** = nur ab (Ø 052) from (Ø 052)

Type Typ	Screw Schraube	Clamp Klemmscheibe	Clamp Screw Klemmschraube	Wrench Schlüssel
FMR04**RD1003	I60M3,5 x 7,7	-	-	WT15P
FMR04**RD12T3	I60M3,5 x 7,7	-	**LOM 3,5 x 7,1	WT15P
FMR04**RD1604	I60M4,5 x 1,0	*WX16N	-	WT20T

● Ex Stock / ab Lager ○ On demand / auf Anfrage * With internal cooling · Mit Innenkühlung

Applicable inserts · Wendeschneidplatten

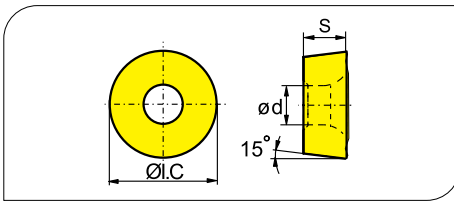

Workpiece Material Werkstoffe	Ideal Machining Condition Gute Bearbeitungsbedingungen			Normal Machining Condition Normale Bearbeitungsbedingungen			Unfavorable Machining Condition Ungünstige Bearbeitungsbedingungen		
	P	M	K	P	M	K	P	M	K
P Steel Stahl	●	●	●	●	●	●	●	●	●
M Stainless Steel Rostfreier Stahl	●	●	●	●	●	●	●	●	●
K Cast iron Gusseisen	●	●	●	●	●	●	●	●	●
N Non-ferrous material Nichte Metalle	●	●	●	●	●	●	●	●	●
S Heat-resistant steel Wärmefester Stahl	●	●	●	●	●	●	●	●	●

Insert shape Plattenform	Type Typ	Dimension (mm) Abmessung			CVD Coating CVD Beschicht.				PVD Coating PVD Beschicht.				Cermet Cermet	Carbide uncoat. unbe. Hartmetall												
		I.C	S	d	YBC302	YBC301	YBC401	YBM253	YBM251	YBM351	YBD152	YBD252		YBG102	YB9320	YBG205	YBG202	YBG212	YBG302	YBG152	YBG252	YNG151	YNG151C	YC30S	YD101	YD201
	RDKW1003MO-1	10.0	3.18	3.9					●	●				●	●	●										
	RDKW1003MO-2	10.0	3.18	3.9										●												
	RDKW1003MO-3	10.0	3.18	3.9				●								●										
	RDKW12T3MO-1	12.0	3.97	3.9					●	●					●	●	●									
	RDKW12T3MO-2	12.0	3.97	3.9											●		○								●	
	RDKW12T3MO-3	12.0	3.97	3.9				●									●									
	RDKW1604MO-1	16.0	4.76	5.2						●	●					●	●	●		●						
	RDKW1604MO-2	16.0	4.76	5.2												●										
RDKW1604MO-3	16.0	4.76	5.2	●	●		●							●	●					●						

Recommended cutting data · Empfohlene Schnittdaten

Workpiece material Werkstückstoff	Hardness HB Härte	Grade Sorte	Cutting data Schnittdaten		
			V (m/min)	f (mm/z)	
P Low-carbon steel Soft steel Niedriglegierter Kohlenstoffstahl Baustahl	≤180	YBM251 YBC301	270 (220-350)	0.2 (0.08-0.45)	
		YBM351 YBG302	220 (180-300)	0.25 (0.15-0.45)	
		YBG202	270 (200-360)	0.2 (0.1-0.45)	
	High-carbon steel Alloy steel Hochleg. Kohlenstoffstahl	180-280	YBM251 YBC301	240 (200-320)	0.2 (0.08-0.45)
			YBM351 YBG302	200 (160-280)	0.25 (0.15-0.45)
			YBG202	240 (180-350)	0.2 (0.1-0.45)
Alloy tool steel Leg. Werkzeugstahl	280-350	YBM251 YBC301	220 (180-300)	0.2 (0.08-0.45)	
		YBM351 YBG302	180 (150-250)	0.25 (0.15-0.45)	
		YBG202	220 (170-340)	0.2 (0.1-0.45)	
M Stainless steel Rostfreier Stahl	≤270	YBM251	150 (120-240)	0.2 (0.08-0.45)	
		YBM351 YBG302	150 (100-220)	0.25 (0.1-0.45)	
		YBG202	160 (110-270)	0.2 (0.1-0.45)	
K Cast iron Gusseisen	180-250	YBG102	210 (120-300)	0.2 (0.1-0.45)	

Applicable tool
Werkzeug **B11-B18**

Tools code key
Werkzeug ISO **B26-B27**

Grade selection guide
Sortenauswahl **B19-B23**

Technical data
Technische Daten **B236-B241**

Milling · Fräsen

Indexable Milling Tools · Wendeplattenfräser

Case study for FMR04
Bearbeitungsbeispiel für FMA04



Workpiece material
Werkstoff: 42CrMo (HRC35)
Cooling system: dry cutting
Kühlsystem: trocken

Machine: vertical machining center
Maschine: vertikales Maschinen-Center

Cutting data
Schnittdaten:
 $V_c=200\text{m/min}$
 $a_p=3\text{mm}$
 $f_z=0.3\text{mm/z}$

- Tool · Werkzeug: FMR04-063-A22-RD12-04
- Inserts · WSP: RDKW1204MO/YBG202



- Wear comparison after 90 min
Verschleißvergleich nach 90 min

ZCC-CT



Competitor A
Wettbewerber A



● Ex Stock / ab Lager ○ On demand / auf Anfrage

Square shoulder milling tools · Eckfräser

Kr:90°



EMP01 P M K N

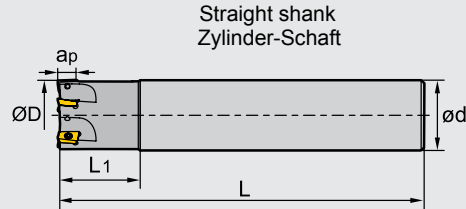



Specification of tools · Werkzeug Beschreibung

Type Typ	* Stock Lager	Dimensions (mm) Abmessungen					No. of teeth Zähne	Weight Gewicht (kg)	
		$\varnothing D$	$\varnothing d$	L	L ₁	a _{pmax}			
EMP01	012-G16-AP11-01	●	12	16	85	25	10.5	1	0.1
	012-G16-AP11-01C	* ○	12	16	85	25	10.5	1	0.1
Straight shank	016-G16-AP11-02	●	16	16	90	25	10.5	2	0.1
	016-G16-AP11-02C	* ●	16	16	90	25	10.5	2	0.1
Zylinder- Schaft	020-G20-AP11-02	●	20	20	100	30	10.5	2	0.2
	020-G20-AP11-02C	* ●	20	20	100	30	10.5	2	0.2
	020-G20-AP11-03	●	20	20	100	30	10.5	3	0.2
	020-G20-AP11-03C	* ●	20	20	100	30	10.5	3	0.2
	025-G25-AP11-03	●	25	25	115	35	10.5	3	0.4
	025-G25-AP11-03C	* ○	25	25	115	35	10.5	3	0.4
	025-G25-AP11-04	●	25	25	115	35	10.5	4	0.4
	025-G25-AP11-04C	* ●	25	25	115	35	10.5	4	0.4
	032-G32-AP11-04	●	32	32	125	40	10.5	4	0.7
	032-G32-AP11-04C	* ○	32	32	125	40	10.5	4	0.7
	025-G25-AP16-02	●	25	25	115	35	15.5	2	0.4
	025-G25-AP16-02C	* ●	25	25	115	35	15.5	2	0.4
	032-G32-AP16-03	●	32	32	125	40	15.5	3	0.7
	032-G32-AP16-03C	* ○	32	32	125	40	15.5	3	0.7
	040-G32-AP16-03	●	40	32	130	42	15.5	3	0.7
	040-G32-AP16-03C	* ●	40	32	130	42	15.5	3	0.7
	040-G32-AP16-04	●	40	32	130	42	15.5	4	0.8
	040-G32-AP16-04C	* ○	40	32	130	42	15.5	4	0.8
	050-G32-AP16-05	●	50	32	135	45	15.5	5	1.0
	050-G32-AP16-05C	* ○	50	32	135	45	15.5	5	1.0
	063-G32-AP16-06	●	63	32	135	45	15.5	6	1.4
	063-G32-AP16-06C	* ○	63	32	135	45	15.5	6	1.4

● Ex stock / ab Lager ○ On demand / auf Anfrage * With internal cooling · Mit Innenkühlung

Spare Parts · Ersatzteile

Diameter Durchmesser $\varnothing D$	Insert WSP	Screw Schraube	Wrench Schlüssel	
				
$\varnothing 12$ - $\varnothing 32$	AP11	I60M2.5×6.5T	WT08IP	--
$\varnothing 25$ - $\varnothing 63$	AP16	I60M4×8.4	--	WT15IS



Applicable tool
Werkzeug **B11-B18**

Tools code key
Werkzeug ISO **B26-B27**

Grade selection guide
Sortenauswahl **B19-B23**

Technical data
Technische Daten **B236-B241**

Milling · Fräsen

Indexable Milling Tools · Wendeplattenfräser

Square shoulder milling tools · Eckfräser

Kr:90°



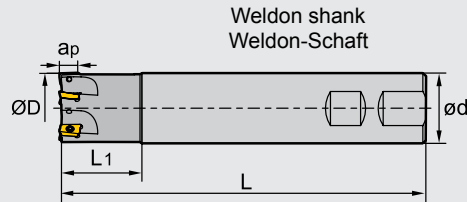

EMP01 P M K N



Specification of tools · Werkzeug Beschreibung

Type Typ	* Stock Lager	Dimensions (mm) Abmessungen					No. of teeth Zähne	Weight Gewicht (kg)	
		Ø D	Ø d	L	L ₁	ap _{max}			
EMP01		•	12	16	85	25	10.5	1	0.1
	*	•	12	16	85	25	10.5	1	0.1
Weldon shank		•	16	16	90	25	10.5	2	0.1
	*	•	16	16	90	25	10.5	2	0.1
Zylinder- Schaft		•	20	20	100	30	10.5	2	0.2
	*	•	20	20	100	30	10.5	2	0.2
		•	20	20	100	30	10.5	3	0.2
	*	•	20	20	100	30	10.5	3	0.2
		•	25	25	115	35	10.5	3	0.4
	*	•	25	25	115	35	10.5	3	0.4
		•	25	25	115	35	10.5	4	0.4
	*	•	25	25	115	35	10.5	4	0.4
		•	32	32	125	40	10.5	4	0.7
	*	•	32	32	125	40	10.5	4	0.7
		•	25	25	115	35	15.5	2	0.4
	*	•	25	25	115	35	15.5	2	0.4
		•	32	32	125	40	15.5	3	0.7
	*	○	32	32	125	40	15.5	3	0.7
		•	40	32	130	42	15.5	4	0.8
	*	•	40	32	130	42	15.5	4	0.8
		•	50	32	135	45	15.5	5	1.0
	*	•	50	32	135	45	15.5	5	1.0
		○	63	32	135	45	15.5	6	1.4
	*	○	63	32	135	45	15.5	6	1.4

Spare Parts · Ersatzteile

Diameter Durchmesser Ø D	Insert WSP	Screw Schraube	Wrench Schlüssel	
				
Ø12-Ø32	AP11	I60M2.5×6.5T	WT08IP	--
Ø25-Ø63	AP16	I60M4×8.4	--	WT15IS



● Ex Stock / ab Lager ○ On demand / auf Anfrage * With internal cooling · Mit Innenkühlung

Milling · Fräsen

Indexable Milling · Fräswendeplatten

■ Applicable inserts · Wendeschneidplatten
 ● Ideal Machining Condition / Gute Bearbeitungsbedingungen
 ● Normal Machining Condition / Normale Bearbeitungsbedingungen
 ● Unfavorable Machining Condition / Ungünstige Bearbeitungsbedingungen

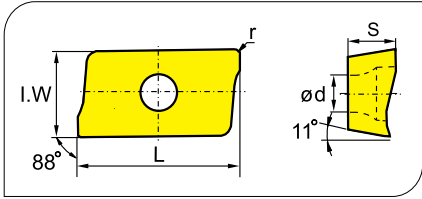

Workpiece Material / Werkstoffe	P	M	K	N	S	Steel / Stahl	Stainless Steel / Rostfreier Stahl	Cast iron / Guss Eisen	Non-ferrite material / Ne Metalle	Heat-resistant steel / Warmfester Stahl
Steel / Stahl	●	●	●	●	●	●	●	●	●	●
Stainless Steel / Rostfreier Stahl	●	●	●	●	●	●	●	●	●	●
Cast iron / Guss Eisen	●	●	●	●	●	●	●	●	●	●
Non-ferrite material / Ne Metalle	●	●	●	●	●	●	●	●	●	●
Heat-resistant steel / Warmfester Stahl	●	●	●	●	●	●	●	●	●	●

Insert shape / Plattenform	Type / Typ	Dimensions (mm) / Abmessungen					CVD Coating / CVD Beschicht.					PVD Coating / PVD Beschicht.					Cermet / Cermet	Carbide uncoat. / unbe. Hartmetall								
		L	I.W	S	d	r	YBC302	YBC301	YBC401	YBM253	YBM251	YBM351	YBD152	YBD252	YBG102	YB9320			YBG205	YBG202	YBG212	YBG302	YBG152	YBG252	YNG151	YNG151C
	APKT11T304-PF	12.24	6.5	3.6	2.8	0.4	○	●							●		●	●								
	APKT11T308-PF	12.24	6.5	3.6	2.8	0.8					●						●									
	APKT11T312-PF	12.24	6.5	3.6	2.8	1.2												○								
	APKT11T316-PF	12.24	6.5	3.6	2.8	1.6												●								
	APKT160408-PF	17.877	9.33	5.76	4.4	0.8		●			●	●						●		●						
	APKT160430-PF	17.877	9.33	5.76	4.4	3.0	●																			
	APKT11T304-PM	12.24	6.5	3.6	2.8	0.4	●	●	●		●	●			●		●	●								
	APKT11T308-PM	12.24	6.5	3.6	2.8	0.8	●	●	●		●	●	●	●	●		●	●	●							
	APKT11T312-PM	12.24	6.5	3.6	2.8	1.2					●				●		●		●							
	APKT11T316-PM	12.24	6.5	3.6	2.8	1.6					●				●		●									
	APKT160408-PM	17.877	9.33	5.76	4.4	0.8	●	●	●	●	●	●	●	●	●		●	●	●	●						
	APKT160416-PM	17.877	9.33	5.76	4.4	1.6	●										●									
	APKT11T304-PR	12.24	6.5	3.6	2.8	0.4					●						●		●							
	APKT11T308-PR	12.24	6.5	3.6	2.8	0.8													○							
	APKT11T312-PR	12.24	6.5	3.6	2.8	1.2													○							
	APKT11T316-PR	12.24	6.5	3.6	2.8	1.6													○							
	APKT160408-PR	17.877	9.33	5.76	4.4	0.8													○							
	APKT11T304-LH	12.24	6.5	3.6	2.8	0.4																		●	●	
	APKT11T308-LH	12.24	6.5	3.6	2.8	0.8																		●	●	
	APKT160408-LH	17.877	9.33	5.76	4.4	0.8																		●	●	
	APKT11T304-APF	12.24	6.5	3.6	2.8	0.4										●										
	APKT11T308-APF	12.24	6.5	3.6	2.8	0.8										●										
	APKT160408-APF	17.877	9.33	5.76	4.4	0.8										●	●		●							
	APKT11T304-APM	12.24	6.5	3.6	2.8	0.4																				
	APKT11T308-APM	12.24	6.5	3.6	2.8	0.8					●						●									
	APKT11T312-APM	12.24	6.5	3.6	2.8	1.2					●						●									
	APKT11T316-APM	12.24	6.5	3.6	2.8	1.6					●						●									
	APKT11T320-APM	12.24	6.5	3.6	2.8	2.0					●						●									
	APKT160408-APM	17.877	9.33	5.76	4.4	0.8					●					●	●		●							
	APKT160416-APM	17.877	9.33	5.76	4.4	1.6					●						●									
	APKT160420-APM	17.877	9.33	5.76	4.4	2.0					●						●									
	APKT160424-APM	17.877	9.33	5.76	4.4	2.4					●						●									
	APKT160430-APM	17.877	9.33	5.76	4.4	3.0					●						●									
	APKT11T304-ALH	12.24	6.5	3.6	2.8	0.4																		●	●	
	APKT11T308-ALH	12.24	6.5	3.6	2.8	0.8																		●	●	
	APKT160408-ALH	17.877	9.33	5.76	4.4	0.8																		●	●	

Applicable tool B11-B18
Werkzeug

Tools code key B26-B27
Werkzeug ISO

Grade selection guide B19-B23
Sortenauswahl

Technical data B236-B241
Technische Daten

Milling · Fräsen

Indexable Milling Tools · Wendepplattenfräser

Chipbreaker Selection EMP01 · Spanbrecher Auswahl EMP01

Application Anwendung	Finishing Schlichten	Semi-Finishing Mittlere Bearbeitung	Roughing Schruppen
P	-PF -APF	-PM -APM	-PR
M	-PF -APF	-PM -APM	-PR
K	-PF	-PM -APM	
AL	-ALH -LH		

1 Square shoulder milling 1 Eckfräsen

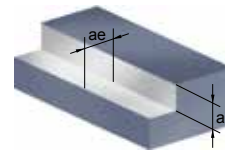

Recommended cutting data · Empfohlene Schnittdaten

Workpiece material Werkstück Material	Hardness HB Härte	Grade Sorte	Cutting data Schnittdaten				
			V(m/min)	f(mm/z)			ae(mm)
				-PF	-PM	-PR	
P	Low-carbon steel Soft steel Niedrig legierter Kohlenstoffstahl Baustahl	YBM251 YBC301	320 (240-400)	0.1 (0.08-0.2)	0.2 (0.1-0.3)	0.25(0.2-0.35)	≤0.5D
		YBM351	260 (180-380)	0.1 (0.08-0.2)	0.2 (0.1-0.3)	0.25(0.2-0.35)	≤0.5D
		YBG202 YBG205	320 (200-400)	0.1 (0.08-0.2)	0.2 (0.1-0.3)	0.25(0.2-0.35)	≤0.5D
		YBG302	280 (180-400)	0.1 (0.08-0.2)	0.2 (0.1-0.3)	0.25(0.2-0.35)	≤0.5D
	High-carbon steel Alloy steel Hoch Leg. Kohlenstoffstahl Leg. Stahl	YBM251 YBC301	280 (210-380)	0.1 (0.08-0.2)	0.2 (0.1-0.3)	0.25(0.2-0.3)	≤0.5D
		YBM351	240 (160-320)	0.1 (0.08-0.2)	0.2 (0.1-0.3)	0.25(0.2-0.35)	≤0.5D
		YBG202 YBG205 YB9320	280 (180-350)	0.1 (0.08-0.2)	0.2 (0.1-0.3)	0.25(0.2-0.3)	≤0.5D
		YBG302	260 (150-380)	0.1 (0.08-0.2)	0.2 (0.1-0.3)	0.25(0.2-0.35)	≤0.5D
	Alloy tool steel Leg. Werkzeugstahl	YBM251 YBC301	260 (180-350)	0.1 (0.08-0.2)	0.2 (0.1-0.3)	0.25(0.2-0.3)	≤0.5D
		YBM351	220 (150-280)	0.1 (0.08-0.2)	0.2 (0.1-0.3)	0.25(0.2-0.35)	≤0.5D
		YBG202 YBG205	260 (160-330)	0.1 (0.08-0.2)	0.2 (0.1-0.3)	0.25(0.2-0.3)	≤0.5D
		YBG302	240 (120-350)	0.1 (0.08-0.2)	0.2 (0.1-0.3)	0.25(0.2-0.35)	≤0.5D
M	Stainless steel Rostfreier Stahl	YBM251	200 (120-270)	0.1 (0.08-0.2)	0.2 (0.1-0.3)	0.25(0.2-0.3)	≤0.5D
		YBM351	180 (150-300)	0.1 (0.08-0.2)	0.2 (0.1-0.3)	0.25(0.2-0.3)	≤0.5D
		YBG202 YBG205	200 (110-300)	0.1 (0.08-0.2)	0.2 (0.1-0.3)	0.25(0.2-0.3)	≤0.5D
		YBG302	170 (100-280)	0.1 (0.08-0.2)	0.2 (0.1-0.3)	0.25(0.2-0.3)	≤0.5D
K	Cast iron Gusseisen	YBG102	220 (120-250)	0.1 (0.08-0.2)	0.2 (0.1-0.3)	-	≤0.5D
		YBD152	240 (180-300)	-	0.2 (0.1-0.3)	-	≤0.5D
		YBD252	200 (120-320)	-	0.2 (0.1-0.3)	-	≤0.5D
N	Al alloy Al Leg.	YD101	300-	-LH			≤0.5D
		YD201	300-	0.2 (0.08-0.4)			≤0.5D

2 Slot milling 2 Nutenfräsen

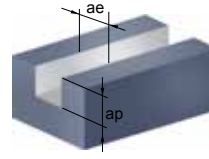

Recommended cutting data · Empfohlene Schnittdaten

Workpiece material Werkstück Material	Hardness HB Härte	Grade Sorte	Cutting data Schnittdaten					
			V(m/min)	f(mm/z)			ae(mm)	
				-PF	-PM	-PR		
P	Low-carbon steel Soft steel Niedrig legierter Kohlenstoffstahl Baustahl	≤180	YBM251	190 (170-250)	0.1 (0.08-0.15)	0.15 (0.1-0.25)	0.2 (0.2-0.3)	D
			YBC301					
			YBM351	150 (130-210)	0.1 (0.08-0.15)	0.15 (0.1-0.25)	0.2 (0.2-0.3)	D
			YBG202 YBG205	190 (140-250)	0.1 (0.08-0.15)	0.15 (0.1-0.25)	0.2 (0.2-0.3)	D
	High-carbon steel Alloy steel Hoch Leg. Kohlenstoffstahl Leg. Stahl	180-280	YBM251	170 (150-220)	0.1 (0.08-0.15)	0.15 (0.1-0.25)	0.2 (0.2-0.3)	D
			YBC301					
			YBM351	140 (110-200)	0.1 (0.08-0.15)	0.15 (0.1-0.25)	0.2 (0.2-0.3)	D
			YBG202 YBG205	170 (130-250)	0.1 (0.08-0.15)	0.15 (0.1-0.25)	0.2 (0.2-0.3)	D
	Alloy tool steel Leg. Werkzeugstahl	280-350	YBM251	150 (130-210)	0.1 (0.08-0.15)	0.15 (0.1-0.25)	0.2 (0.2-0.3)	D
			YBC301					
			YBM351	130 (100-180)	0.1 (0.08-0.15)	0.15 (0.1-0.25)	0.2 (0.2-0.3)	D
			YBG202 YBG205	150 (110-240)	0.1 (0.08-0.15)	0.15 (0.1-0.25)	0.2 (0.2-0.3)	D
M	Stainless steel Rostfreier Stahl	≤270	YBM251	110 (80-190)	0.1 (0.08-0.15)	0.15 (0.1-0.25)	0.2 (0.2-0.3)	D
			YBM351	100 (80-170)	0.1 (0.08-0.15)	0.15 (0.1-0.25)	0.2 (0.2-0.3)	D
			YBG202 YBG205	120 (80-190)	0.1 (0.08-0.15)	0.15 (0.1-0.25)	0.2 (0.2-0.3)	D
			YBG302	100 (70-180)	0.1 (0.08-0.15)	0.15 (0.1-0.25)	0.2 (0.2-0.3)	D
K	Cast iron Gusseisen	180-250	YBG102	130 (80-180)	0.1 (0.08-0.15)	0.15 (0.1-0.25)	-	D
			YBD152	140 (80-210)	-	0.15 (0.1-0.25)	-	D
			YBD252	120 (80-210)	-	0.15 (0.1-0.25)	-	D
N	Al alloy Al Leg.	----	YD101	300-	-LH			D
			YD201	300-	0.2 (0.08-0.3)			D

Milling · Fräsen

Indexable Milling Tools · Wendeplattenfräser

3 Ramp milling, helical interpolation milling
3 Tauchfräsen, Spiral Interpolationsfräsen

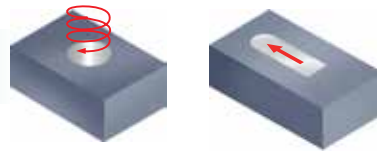

Recommended cutting data · Empfohlene Schnittdaten

Ramp milling Tauchfräsen

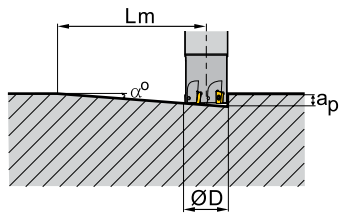

$$L_m = \frac{a_p}{\tan \alpha}$$

(α: Maximum ramp angle)
(α: Maximaler Eintauchwinkel)

Helical interpolation milling Spiral-Interpolationsfräsen

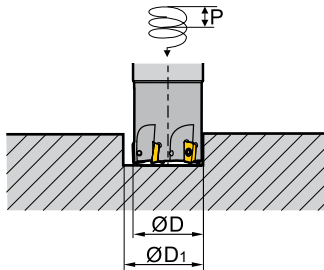

$$\tan \alpha = \frac{P}{\pi D_1}$$

(α: helical angle)
(α: Spiral Winkel)

Diameter Durchmesser Ø D (mm)	APKT Ramp milling, helical interpolation milling (Inserts—11) APKT Tauchfräsen, Spiral-Interpolationsfräsen				
	Ramp milling Tauchfräsen			Helical interpolation milling Spiral-Interpolationsfräsen	
	Max. cutting depth Schnitttiefe a_p(mm)	Max. ramp angle Eintauchwinkel α°	Min. length Länge L _m (mm)	Min. diameter Durchmesser Ø D ₁ (mm)	Max. pitch Steigung (mm)
16	10.0	10.0	56.7	20.0	2.0
20	10.0	5.0	114.4	28.0	2.0
25	10.0	4.5	127.0	40.0	2.0
32	10.0	3.0	190.8	56.0	2.0
40	10.0	2.0	286.4	70.0	2.0

B

Milling Tools
Fräser

Case study for EMP01 Bearbeitungsbeispiel für EMP01



- Tool · Werkzeug : EMP01-040-XP32-AP16-04
- Inserts · WSP : APKT160408-PM/YBC301

Workpiece material: Cast Steel (HB220)
Werkstück Material:

Cooling system: dry cutting
Kühlsystem: trocken

Machine: vertical machining center
Maschine: vertikales Maschinen-Center

Cutting data:
Schnittdaten:
Vc=180m/min
ap=3mm
fz=0.1mm/z

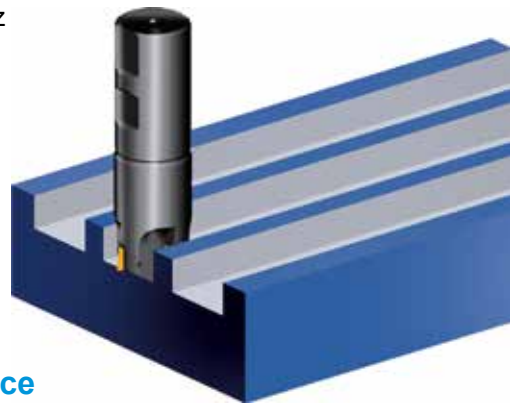

B

Milling Tools
Fräser

- Wear comparison of insert after milling curved face
- Verschleißvergleich der WSP

ZCC-CT

Produkt of competitor
Wettbewerbsprodukt

15'



25'

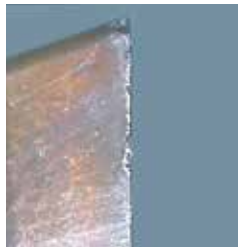

Square shoulder milling tools · Eckfräser

Kr:90°



EMP02 P M K N

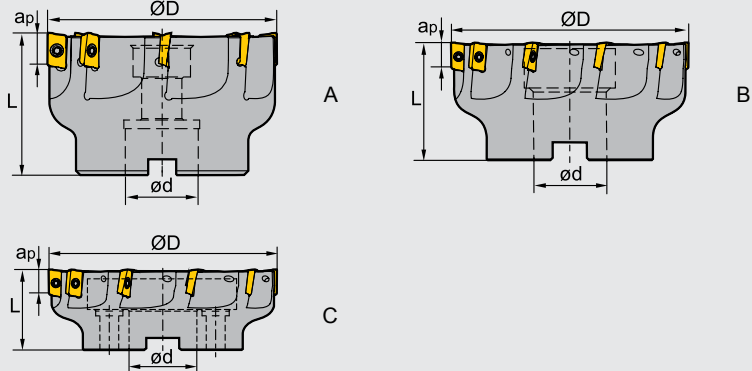





Specification of tools · Werkzeug Beschreibung

Type Typ	*	Stock Lager	Dimensions (mm) Abmessungen				No. of teeth Zähne	Coupling Aufnahme	Weight Gewicht (kg)
			$\varnothing D$	$\varnothing d$	L	a_{pmax}			
EMP02 040-A16-AP11-05C	*	○	40	16	40	11	5	A	0.177
040-A22-AP11-05C	*	●	40	22	40	11	5	A	0.2
050-A22-AP11-06		●	50	22	40	11	6	A	0.3
050-A22-AP11-06C	*	●	50	22	40	11	6	A	0.3
063-A22-AP11-08		●	63	22	40	11	8	A	0.6
063-A22-AP11-08C	*	●	63	22	40	11	8	A	0.6
063-A22-AP11-09C	*	●	63	22	40	11	9	A	0.54
080-A27-AP11-08		●	80	27	50	11	8	A	1.2
080-A27-AP11-08C	*	●	80	27	50	11	8	A	1.2
080-A27-AP11-10C	*	●	80	27	50	11	10	A	1.13
100-B32-AP11-10		●	100	32	50	11	10	B	1.7
100-B32-AP11-10C	*	○	100	32	50	11	10	B	1.7
125-B40-AP11-10		●	125	40	63	11	10	B	3.42
040-A16-AP16-03		○	40	16	40	15.5	3	A	0.17
040-A16-AP16-04C	*	●	40	16	40	15.5	4	A	0.17
050-A22-AP16-05		●	50	22	40	15.5	5	A	0.3
050-A22-AP16-05C	*	●	50	22	40	15.5	5	A	0.3
063-A22-AP16-06		●	63	22	40	15.5	6	A	0.5
063-A22-AP16-06C	*	●	63	22	40	15.5	6	A	0.5
080-A27-AP16-07		●	80	27	50	15.5	7	A	1.1
080-A27-AP16-07C	*	●	80	27	50	15.5	7	A	1.1
100-B32-AP16-08		●	100	32	50	15.5	8	B	1.6
100-B32-AP16-08C	*	●	100	32	50	15.5	8	B	1.6
125-B40-AP16-10		●	125	40	63	15.5	10	B	3.2
125-B40-AP16-10C	*	●	125	40	63	15.5	10	B	3.2
160-B40-AP16-07C	*	●	160	40	63	15.5	7	B	4.3
160-B40-AP16-10		●	160	40	63	15.5	10	B	6.3
160-B40-AP16-10C	*	○	160	40	63	15.5	10	B	6.3
200-C60-AP16-12		○	200	60	63	15.5	12	C	8.1
250-C60-AP16-12		○	250	60	63	15.5	12	C	11.2

● Ex Stock / ab Lager ○ On demand / auf Anfrage * With internal cooling · Mit Innenkühlung

Spare Parts · Ersatzteile

Diameter Durchmesser Ø D	Insert WSP	Screw Schraube	Wrench Schlüssel	
				
Ø50-Ø250	AP11	I60M2.5×6.5T	WT08IS	
Ø50-Ø250	AP16	I60M4×10	WT15IS	

Coupling Aufnahme	Diameter Durchmesser Ø D	Screw·Schraube	Ring·Dichtring
B32	Ø100	 LDB32C	 B32-002-CP
B40	Ø125	LDB40C	B40-002-CP
B40	Ø160	LDB40C	B40-003-CP

Applicable tool
Werkzeug **B11-B18**

Tools code key
Werkzeug ISO **B26-B27**

Grade selection guide
Sortenauswahl **B19-B23**

Technical data
Technische Daten **B236-B241**

Milling · Fräsen

Indexable Milling · Fräswendeplatten

■ Applicable inserts · Wendeschneidplatten

● Ideal Machining Condition
Gute Bearbeitungsbedingungen

● Normal Machining Condition
Normale Bearbeitungsbedingungen

● Unfavorable Machining Condition
Ungünstige Bearbeitungsbedingungen

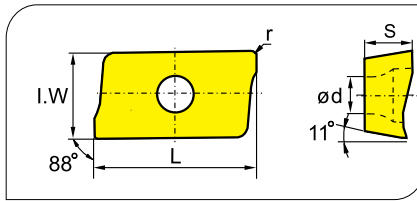

Workpiece Material / Werkstoffe	P	M	K	N	S
Steel / Stahl	●	●	●	●	●
Stainless Steel / Rostfreier Stahl	●	●	●	●	●
Cast iron / Guss Eisen	●	●	●	●	●
Non-ferrite material / Ne Metalle	●	●	●	●	●
Heat-resistant steel / Warmfester Stahl	●	●	●	●	●

Insert shape / Plattenform	Type / Typ	Dimensions (mm) / Abmessungen					CVD Coating / CVD Beschicht.						PVD Coating / PVD Beschicht.						Cermets / Cermet	Carbide uncoat. / unbe. Hartmetall								
		L	I.W	S	d	r	YBC302	YBC301	YBC401	YBM253	YBM251	YBM351	YBD152	YBD252	YBG102	YB9320	YBG205	YBG202		YBG212	YBG302	YBG152	YBG252	YNG151	YNG151C	YC30S	YD101	YD201
	APKT11T304-PF	12.24	6.5	3.6	2.8	0.4	○							●			●											
	APKT11T308-PF	12.24	6.5	3.6	2.8	0.8					●							●										
	APKT11T312-PF	12.24	6.5	3.6	2.8	1.2												○										
	APKT11T316-PF	12.24	6.5	3.6	2.8	1.6												●										
	APKT160408-PF	17.877	9.33	5.76	4.4	0.8		●			●	●			●			●										
	APKT160430-PF	17.877	9.33	5.76	4.4	3.0	●																					
	APKT11T304-PM	12.24	6.5	3.6	2.8	0.4	●	●	●		●	●		●			●											
	APKT11T308-PM	12.24	6.5	3.6	2.8	0.8	●	●	●		●	●	●	●	●	●	●	●	●	●								
	APKT11T312-PM	12.24	6.5	3.6	2.8	1.2					●			●			●			●								
	APKT11T316-PM	12.24	6.5	3.6	2.8	1.6					●			●			●			●								
	APKT160408-PM	17.877	9.33	5.76	4.4	0.8	●	●	●	●	●	●	●	●	●	●	●	●	●	●	●							
	APKT160416-PM	17.877	9.33	5.76	4.4	1.6	●										●											
	APKT11T304-PR	12.24	6.5	3.6	2.8	0.4						●					●			●								
	APKT11T308-PR	12.24	6.5	3.6	2.8	0.8														○								
	APKT11T312-PR	12.24	6.5	3.6	2.8	1.2														○								
	APKT11T316-PR	12.24	6.5	3.6	2.8	1.6														○								
	APKT160408-PR	17.877	9.33	5.76	4.4	0.8														○								
	APKT11T304-LH	12.24	6.5	3.6	2.8	0.4																			●	●		
	APKT11T308-LH	12.24	6.5	3.6	2.8	0.8																			●	●		
	APKT160408-LH	17.877	9.33	5.76	4.4	0.8																			●	●		
	APKT11T304-APF	12.24	6.5	3.6	2.8	0.4										●												
	APKT11T308-APF	12.24	6.5	3.6	2.8	0.8										●												
	APKT160408-APF	17.877	9.33	5.76	4.4	0.8										●	●			●								
	APKT11T304-APM	12.24	6.5	3.6	2.8	0.4										●												
	APKT11T308-APM	12.24	6.5	3.6	2.8	0.8				●		●				●												
	APKT11T312-APM	12.24	6.5	3.6	2.8	1.2					●		●			●												
	APKT11T316-APM	12.24	6.5	3.6	2.8	1.6					●		●			●												
	APKT11T320-APM	12.24	6.5	3.6	2.8	2.0					●		●			●												
	APKT160408-APM	17.877	9.33	5.76	4.4	0.8										●	●											
	APKT160416-APM	17.877	9.33	5.76	4.4	1.6					●		●			●												
	APKT160420-APM	17.877	9.33	5.76	4.4	2.0					●		●			●												
	APKT160424-APM	17.877	9.33	5.76	4.4	2.4					●		●			●												
	APKT160430-APM	17.877	9.33	5.76	4.4	3.0					●		●			●												
	APKT11T304-ALH	12.24	6.5	3.6	2.8	0.4																			●	●		
	APKT11T308-ALH	12.24	6.5	3.6	2.8	0.8																			●	●		
	APKT160408-ALH	17.877	9.33	5.76	4.4	0.8																			●	●		

● Ex Stock / ab Lager ○ On demand / auf Anfrage

Chipbreaker Selection · Spanbrecher Auswahl

Application Anwendung	Finishing Schlichten	Semi-Finishing Mittlere Bearbeitung	Roughing Schruppen
P	-PF -APF	-PM -APM	-PR
M	-PF -APF	-PM -APM	-PR
K	-PF	-PM -APM	
AL	-LH -ALH		

Square shoulder milling Eckfräsen

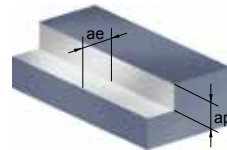

Recommended cutting data · Empfohlene Schnittdaten

Workpiece material Werkstück Material	Hardness HB Härte	Grade Sorte	Cutting data Schnittdaten					
			V(m/min)	f(mm/z)			ae(mm)	
				-PF	-PM	-PR		
P Low-carbon steel Soft steel Niedrig legierter Kohlenstoffstahl Baustahl	≤180	YBM251 YBC301	320 (240-400)	0.1 (0.08-0.2)	0.2 (0.1-0.3)	0.25(0.2-0.35)	≤0.5D	
		YBM351	260 (180-380)	0.1 (0.08-0.2)	0.2 (0.1-0.3)	0.25(0.2-0.35)	≤0.5D	
		YBG202 YBG205 YB9320	320 (200-400)	0.1 (0.08-0.2)	0.2 (0.1-0.3)	0.25(0.2-0.35)	≤0.5D	
		YBG302	280 (180-400)	0.1 (0.08-0.2)	0.2 (0.1-0.3)	0.25(0.2-0.35)	≤0.5D	
	High-carbon steel Alloy steel Hoch Leg. Kohlenstoffstahl Leg. Stahl	180-280	YBM251 YBC301	280 (210-380)	0.1 (0.08-0.2)	0.2 (0.1-0.3)	0.25(0.2-0.3)	≤0.5D
			YBM351	240 (160-320)	0.1 (0.08-0.2)	0.2 (0.1-0.3)	0.25(0.2-0.35)	≤0.5D
			YBG202 YBG205 YB9320	280 (180-350)	0.1 (0.08-0.2)	0.2 (0.1-0.3)	0.25(0.2-0.3)	≤0.5D
			YBG302	260 (150-380)	0.1 (0.08-0.2)	0.2 (0.1-0.3)	0.25(0.2-0.35)	≤0.5D
	Alloy tool steel Leg. Werkzeugstahl	280-350	YBM251 YBC301	260 (180-350)	0.1 (0.08-0.2)	0.2 (0.1-0.3)	0.25(0.2-0.3)	≤0.5D
			YBM351	220 (150-280)	0.1 (0.08-0.2)	0.2 (0.1-0.3)	0.25(0.2-0.35)	≤0.5D
			YBG202 YB9320	260 (160-330)	0.1 (0.08-0.2)	0.2 (0.1-0.3)	0.25(0.2-0.3)	≤0.5D
			YBG302	240 (120-350)	0.1 (0.08-0.2)	0.2 (0.1-0.3)	0.25(0.2-0.35)	≤0.5D
M Stainless steel Rostfreier Stahl	≤270	YBM251	200 (120-270)	0.1 (0.08-0.2)	0.2 (0.1-0.3)	0.25(0.2-0.3)	≤0.5D	
		YBM351	180 (150-300)	0.1 (0.08-0.2)	0.2 (0.1-0.3)	0.25(0.2-0.3)	≤0.5D	
		YBG202 YB9320	200 (110-300)	0.1 (0.08-0.2)	0.2 (0.1-0.3)	0.25(0.2-0.3)	≤0.5D	
		YBG302	170 (100-280)	0.1 (0.08-0.2)	0.2 (0.1-0.3)	0.25(0.2-0.3)	≤0.5D	
K Cast iron Gusseisen	180-250	YBG102	220 (120-250)	0.1 (0.08-0.2)	0.2 (0.1-0.3)	-	≤0.5D	
		YBD152	240 (180-300)	-	0.2 (0.1-0.3)	-	≤0.5D	
		YBD252	200 (120-320)	-	0.2 (0.1-0.3)	-	≤0.5D	
N Al alloy Al Leg.	----	YD101	300-	-LH 0.2 (0.08-0.4)			≤0.5D	
		YD201	300-	0.2 (0.08-0.4)			≤0.5D	

Milling · Fräsen

Indexable Milling Tools · Wendeplattenfräser

Square shoulder milling tools · Eckfräser

Kr:90°



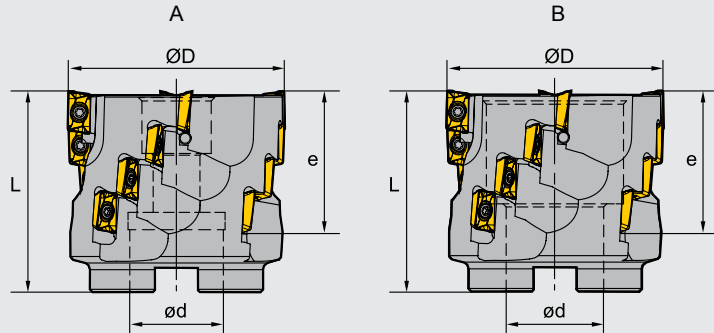

EMPO3 P M K N



Specification of tools · Werkzeug Beschreibung

Type Typ	*	Stock Lager	Dimensions (mm) Abmessungen				Flute number Zahn- reihen z	No. of inserts WSP Anzahl	Coupling Aufnahme	Weight Gewicht (kg)
			Ø D	Ø d	L	e				
EMPO3 -050-A22-AP11-04		●	50	22	58	39	4	16	A	0.5
-050-A22-AP11-04C	*	○	50	22	58	39	4	16	A	0.5
-063-A27-AP11-04		●	63	27	58	39	4	16	A	0.9
-063-A27-AP11-04C	*	○	63	27	58	39	4	16	A	0.9
-080-B32-AP11-05		●	80	32	63	39	5	20	B	1.3
-080-B32-AP11-05C	*	○	80	32	63	39	5	20	B	1.3
-100-B40-AP11-06		●	100	40	63	39	6	24	B	2.0
-100-B40-AP11-06C	*	○	100	40	63	39	6	24	B	2.0

Spare Parts · Ersatzteile

Diameter Durchmesser Ø D	Screw Schraube	Wrench Schlüssel	
Ø50-Ø100	 I60M2.5×6.5T	 WT08IS	

● Ex Stock / ab Lager ○ On demand / auf Anfrage * With internal cooling · Mit Innenkühlung

Square shoulder milling tools · Eckfräser

Kr:90°



EMP04 **P** **M** **K** **N**

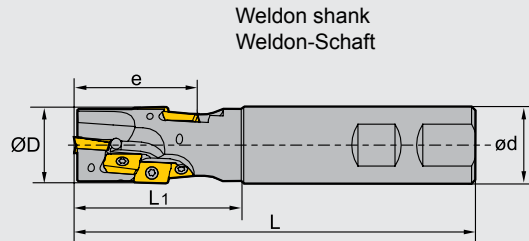



Specification of tools · Werkzeug Beschreibung

Type Typ	* Stock Lager	Dimensions (mm) Abmessungen			Flute number Zahn- reihen z	No. of inserts WSP Anzahl	Weight Gewicht (kg)		
		Ø D	Ø d	L					
EMP04 -020-XP20-AP11-01	●	20	20	120	45	29.4	1	3	0.3
-025-XP25-AP11-02	●	25	25	130	55	38.9	2	8	0.4
-032-XP32-AP11-02	●	32	32	140	65	48.5	2	10	0.7
-040-XP40-AP11-02	●	40	40	150	75	58.0	2	14	1.3

● Ex stock / ab Lager ○ On demand / auf Anfrage * With internal cooling · Mit Innenkühlung

Spare Parts · Ersatzteile

Diameter Durchmesser Ø D	Screw Schraube	Wrench Schlüssel
Ø20-Ø40	 I60M2.5×6.5T	 WT08IS



Applicable tool **B11-B18**
Werkzeug

Tools code key **B26-B27**
Werkzeug ISO

Grade selection guide **B19-B23**
Sortenauswahl

Technical data **B236-B241**
Technische Daten

Milling · Fräsen

Indexable Milling · Fräswendeplatten

■ Applicable inserts · Wendeschneidplatten
 ● Ideal Machining Condition / Gute Bearbeitungsbedingungen
 ● Normal Machining Condition / Normale Bearbeitungsbedingungen
 ● Unfavorable Machining Condition / Ungünstige Bearbeitungsbedingungen

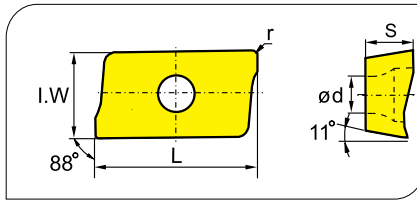

Workpiece Material / Werkstoffe	P	M	K	N	S	Steel / Stahl	Stainless Steel / Rostfreier Stahl	Cast iron / Guss Eisen	Non-ferrous material / Ne Metalle	Heat-resistant steel / Warmfester Stahl
Steel / Stahl	●	●	●	●	●	●	●	●	●	●
Stainless Steel / Rostfreier Stahl	●	●	●	●	●	●	●	●	●	●
Cast iron / Guss Eisen	●	●	●	●	●	●	●	●	●	●
Non-ferrous material / Ne Metalle	●	●	●	●	●	●	●	●	●	●
Heat-resistant steel / Warmfester Stahl	●	●	●	●	●	●	●	●	●	●

B

Milling Tools
Fräser

Insert shape Plattenform	Type Typ	Dimensions (mm) Abmessungen					CVD Coating CVD Beschicht.						PVD Coating PVD Beschicht.						Cermet Cermet	Carbide uncoat. unbe. Hartmetall								
		L	I.W	S	d	r	YBC302	YBC301	YBC401	YBM253	YBM251	YBM351	YBD152	YBD252	YBG102	YB9320	YBG205	YBG202		YBG212	YBG302	YBG152	YBG252	YNG151	YNG151C	YC30S	YD101	YD201
	APKT11T304-PF	12.24	6.5	3.6	2.8	0.4		○			●				●			●										
	APKT11T308-PF	12.24	6.5	3.6	2.8	0.8					●								●									
	APKT11T312-PF	12.24	6.5	3.6	2.8	1.2													●									
	APKT11T316-PF	12.24	6.5	3.6	2.8	1.6										●			●									
	APKT11T304-PM	12.24	6.5	3.6	2.8	0.4	●	●	●		●	●			●			●		●								
	APKT11T308-PM	12.24	6.5	3.6	2.8	0.8	●	●		●	●	●	●	●	●			●		●								
	APKT11T312-PM	12.24	6.5	3.6	2.8	1.2					●				●			●		●								
	APKT11T316-PM	12.24	6.5	3.6	2.8	1.6					●				●			●										
	APKT11T304-PR	12.24	6.5	3.6	2.8	0.4						●						●		●								
	APKT11T308-PR	12.24	6.5	3.6	2.8	0.8														○								
	APKT11T312-PR	12.24	6.5	3.6	2.8	1.2														○								
	APKT11T316-PR	12.24	6.5	3.6	2.8	1.6														○								
	APKT11T304-LH	12.24	6.5	3.6	2.8	0.4																			●	●		
	APKT11T308-LH	12.24	6.5	3.6	2.8	0.8																			●	●		
	APKT11T304-APF	12.24	6.5	3.6	2.8	0.4																						
	APKT11T308-APF	12.24	6.5	3.6	2.8	0.8																						
	APKT11T304-APM	12.24	6.5	3.6	2.8	0.4																						
	APKT11T308-APM	12.24	6.5	3.6	2.8	0.8				●		●			●			●										
	APKT11T312-APM	12.24	6.5	3.6	2.8	1.2				●		●			●			●										
	APKT11T316-APM	12.24	6.5	3.6	2.8	1.6				●		●			●			●										
	APKT11T320-APM	12.24	6.5	3.6	2.8	2.0				●		●			●			●										
	APKT11T304-ALH	12.24	6.5	3.6	2.8	0.4																			●	●		
	APKT11T308-ALH	12.24	6.5	3.6	2.8	0.8																			●	●		

● Ex Stock / ab Lager ○ On demand / auf Anfrage

Chipbreaker Selection · Spanbrecher Auswahl

Application Anwendung	Finishing Schlichten	Semi-Finishing Mittlere Bearbeitung	Roughing Schruppen
P	-PF -APF	-PM -APM	-PR
M	-PF -APF	-PM -APM	-PR
K	-PF	-PM -APM	
AL	-LH -ALH		

Recommended cutting data · Empfohlene Schnittdaten

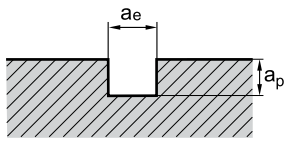
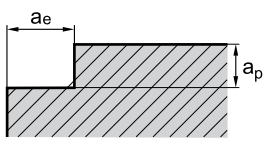
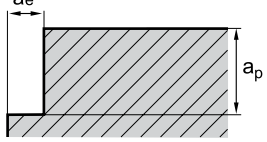
Slot milling Nutenfräsen	Square shoulder milling Eckfräsen	Deep square shoulder milling Tiefes Eckfräsen
		
ae=D ap:≤0.5D	ae:≤0.5D ap:≤1.2D	ae:≤0.2D ap<Cutting length of insert Schneidkantenlänge

Workpiece material Werkstück Material	Hardness HB Härte	Grade Sorte	Cutting data Schnittdaten			
			Square shoulder milling Eckfräsen			
			V(m/min)	f(mm/z)		
			-PF	-PM	-PR	
P	Low-carbon steel Soft steel Niedrig legierter Kohlenstoffstahl Baustahl	YBM251 YBC301	270 (240-350)	0.1 (0.08-0.2)	0.2 (0.1-0.3)	0.25(0.2-0.35)
		YBM351	220 (180-300)	0.1 (0.08-0.2)	0.2 (0.1-0.3)	0.25(0.2-0.35)
		YBG202 YBG205 YB9320	270 (200-360)	0.1 (0.08-0.2)	0.2 (0.1-0.3)	0.25(0.2-0.35)
		YBG302	240 (180-350)	0.1 (0.08-0.2)	0.2 (0.1-0.3)	0.25(0.2-0.35)
	High-carbon steel Alloy steel Hoch Leg. Kohlenstoffstahl Leg. Stahl	YBM251 YBC301	240 (210-320)	0.1 (0.08-0.2)	0.2 (0.1-0.3)	0.25(0.2-0.35)
		YBM351	200 (160-280)	0.1 (0.08-0.2)	0.2 (0.1-0.3)	0.25(0.2-0.35)
		YBG202 YBG205 YB9320	240 (180-360)	0.1 (0.08-0.2)	0.2 (0.1-0.3)	0.25(0.2-0.35)
		YBG302	220 (150-330)	0.1 (0.08-0.2)	0.2 (0.1-0.3)	0.25(0.2-0.35)
	Alloy tool steel Leg. Werkzeugstahl	YBM251 YBC301	220 (180-300)	0.1 (0.08-0.2)	0.2 (0.1-0.3)	0.25(0.2-0.35)
		YBM351	180 (150-250)	0.1 (0.08-0.2)	0.2 (0.1-0.3)	0.25(0.2-0.35)
		YBG202 YBG205 YB9320	220 (160-340)	0.1 (0.08-0.2)	0.2 (0.1-0.3)	0.25(0.2-0.35)
		YBG302	200 (120-300)	0.1 (0.08-0.2)	0.2 (0.1-0.3)	0.25(0.2-0.35)
M	Stainless steel Rostfreier Stahl	YBM251	170 (120-240)	0.1 (0.08-0.2)	0.2 (0.1-0.3)	0.25(0.2-0.35)
		YBM351	160 (150-270)	0.1 (0.08-0.2)	0.2 (0.1-0.3)	0.25(0.2-0.35)
		YBG202 YBG205	150 (110-270)	0.1 (0.08-0.2)	0.2 (0.1-0.3)	0.25(0.2-0.35)
		YBG302	140 (100-250)	0.1 (0.08-0.2)	0.2 (0.1-0.3)	0.25(0.2-0.35)
K	Cast iron Gusseisen	YBG102	200 (120-240)	0.1 (0.08-0.2)	0.2 (0.1-0.3)	-
		YBD152	240 (180-300)	0.1 (0.08-0.2)	0.2 (0.1-0.3)	-
		YBD252	180 (120-300)	-	0.2 (0.1-0.3)	-
N	Al alloy Al Leg.	YD101	300-	-ALH -LH		
		YD201	300-	0.2 (0.08-0.4)		

Milling · Fräsen

Indexable Milling Tools · Wendepplattenfräser

Recommended cutting data · Empfohlene Schnittdaten

Workpiece material Werkstück Material	Hardness HB Härte	Grade Sorte	Cutting data Schnittdaten				
			Slot milling, deep square shoulder milling Nutenfräsen, Eckfräsen				
			V(m/min)	f(mm/z)			
-PF	-PM	-PR					
P Low-carbon steel Soft steel Niedrig legierter Kohlenstoffstahl Baustahl	≤180	YBM251	270 (240-350)	0.1 (0.08-0.15)	0.15 (0.1-0.25)	0.2 (0.2-0.3)	
		YBC301					
		YBM351	220 (180-300)	0.1 (0.08-0.15)	0.15 (0.1-0.25)	0.2 (0.2-0.3)	
		YBG202					
	YBG205	270 (200-360)	0.1 (0.08-0.15)	0.15 (0.1-0.25)	0.2 (0.2-0.3)		
	YB9320						
	YBG302	240 (180-350)	0.1 (0.08-0.15)	0.15 (0.1-0.25)	0.2 (0.2-0.3)		
	180-280	YBM251	240 (210-320)	0.1 (0.08-0.15)	0.15 (0.1-0.25)	0.2 (0.2-0.3)	
		YBC301					
		YBM351	200 (160-280)	0.1 (0.08-0.15)	0.15 (0.1-0.25)	0.2 (0.2-0.3)	
		YBG202					
	YBG205	240 (180-360)	0.1 (0.08-0.15)	0.15 (0.1-0.25)	0.2 (0.2-0.3)		
YB9320							
YBG302	220 (150-330)	0.1 (0.08-0.15)	0.15 (0.1-0.25)	0.2 (0.2-0.3)			
280-350	YBM251	220 (180-300)	0.1 (0.08-0.15)	0.15 (0.1-0.25)	0.2 (0.2-0.3)		
	YBC301						
	YBM351	180 (150-250)	0.1 (0.08-0.15)	0.15 (0.1-0.25)	0.2 (0.2-0.3)		
	YBG202						
YBG205	220 (160-340)	0.1 (0.08-0.15)	0.15 (0.1-0.25)	0.2 (0.2-0.3)			
YB9320							
YBG302	200 (120-300)	0.1 (0.08-0.15)	0.15 (0.1-0.25)	0.2 (0.2-0.3)			
M Stainless steel Rostfreier Stahl	≤270	YBM251	170 (120-240)	0.1 (0.08-0.15)	0.15 (0.1-0.25)	0.2 (0.2-0.3)	
		YBM351	160 (150-270)	0.1 (0.08-0.15)	0.15 (0.1-0.25)	0.2 (0.2-0.3)	
		YBG202					
		YBG205	150 (110-270)	0.1 (0.08-0.15)	0.15 (0.1-0.25)	0.2 (0.2-0.3)	
YB9320							
YBG302	140 (100-250)	0.1 (0.08-0.15)	0.15 (0.1-0.25)	0.2 (0.2-0.3)			
K Cast iron Gusseisen	180-250	YBG102	200 (120-240)	0.1 (0.08-0.15)	0.15 (0.1-0.25)	-	
		YBD152	240 (180-300)	0.1 (0.08-0.15)	0.15 (0.1-0.25)	-	
		YBD252	180 (120-300)	-	0.15 (0.1-0.25)	-	
N	---	YD101	300-	-ALH -LH			
		YD201	300-	0.2 (0.08-0.3)			
				0.2 (0.08-0.3)			

● Ex Stock / ab Lager ○ On demand / auf Anfrage

Square shoulder milling tools · Eckfräser

Kr:90°



EMP05 **P** **M** **K**

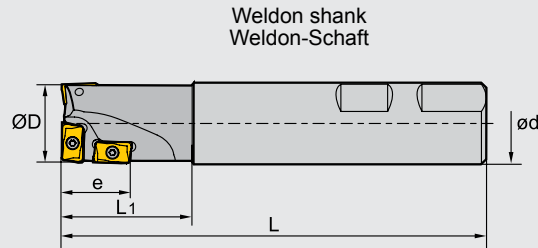

Specification of tools · Werkzeug Beschreibung

Type Typ	*	Stock Lager	Dimensions (mm) Abmessungen						No. of inserts WSP Anzahl		Weight Gewicht (kg)
			R	Ø D	Ø d	L	L ₁	e	APMT11	APMT16	
EMP05		●		25	25	130	40	20	3	--	0.5
	*	●		25	25	130	40	20	3	--	0.5
		●		32	32	140	50	30	--	3	0.8
	*	●		32	32	140	50	30	--	3	0.8
		●		40	32	150	60	40	--	4	1.0
	*	●		40	32	150	60	40	--	4	1.0

● Ex stock / ab Lager ○ On demand / auf Anfrage * With internal cooling · Mit Innenkühlung

Spare Parts · Ersatzteile

Diameter Durchmesser Ø D	Insert WSP	Screw Schraube	Wrench Schlüssel	
Ø25-Ø40	APMT11	I60M2.5×6.5T	WT08IP	
	APMT16	I60M4×10	WT15IP	

Applicable tool **B11-B18**
Werkzeug

Tools code key **B26-B27**
Werkzeug ISO

Grade selection guide **B19-B23**
Sortenauswahl

Technical data **B236-B241**
Technische Daten

Milling · Fräsen

Indexable Milling · Fräswendeplatten

Applicable inserts · Wendeschneidplatten

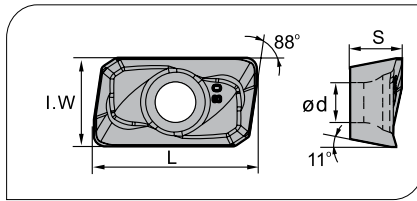

Workpiece Material Werkstoffe	Ideal Machining Condition Gute Bearbeitungsbedingungen			Normal Machining Condition Normale Bearbeitungsbedingungen			Unfavorable Machining Condition Ungünstige Bearbeitungsbedingungen			
	P	M	K	N	S					
P Steel Stahl	●	●	●	●	●	●	●	●	●	●
M Stainless Steel Rostfreier Stahl	●	●	●	●	●	●	●	●	●	●
K Cast iron Gusseisen						●	●	●	●	●
N Non-ferrous material Nichte Metalle									●	●
S Heat-resistant steel Warmfester Stahl						●	●	●	●	●

Insert shape Plattenform	Type Typ	Dimensions (mm) Abmessungen					CVD Coating CVD Beschicht.						PVD Coating PVD Beschicht.				Cermets Cermet	Carbide uncoat. unbe. Hartmetall										
		L	I.W	S	d	r	YBC302	YBC301	YBC401	YBM253	YBM251	YBM351	YBD152	YBD252	YBG102	YBG320		YBG205	YBG202	YBG212	YBC302	YBG152	YBG252	YNG151	YNG151C	YC30S	YD101	YD201
	APMT1135PDR	11.25	6.2	3.5	2.8	0.8					○					●	○		○									
	APMT160408PDER	17.25	9.25	4.76	4.4	0.8					○					●	○		○									

1 Plunge Milling Tauchfräsen



Recommended cutting data · Empfohlene Schnittdaten

	Workpiece material Werkstück Material	Hardness HB Härte	Grade Sorte	Cutting data · Schnittdaten	
				V(m/min)	f(mm/z)
P	Low-carbon steel Soft steel Niedrig legierter Kohlenstoffstahl Baustahl	≤180	YBG202 YBG205	180 (150-220)	0.2 (0.08-0.25)
	High-carbon steel Alloy steel Hoch Leg. Kohlenstoffstahl	180-280	YBG202 YBG205	160 (130-200)	0.15 (0.08-0.2)
	Alloy tool steel Leg. Werkzeugstahl	280-350	YBG202 YBG205	140 (120-180)	0.12 (0.05-0.2)
M	Stainless steel Rostfreier Stahl	≤270	YBG202 YBG205	80 (50-150)	0.08 (0.03-0.15)
K	Cast iron Gusseisen	180-250	YBG202 YBG205	150 (100-220)	0.15 (0.08-0.2)

2 Milling Fräsen

Recommended cutting data · Empfohlene Schnittdaten

	Workpiece material Werkstück Material	Hardness HB Härte	Grade Sorte	Cutting data · Schnittdaten	
				V(m/min)	f(mm/z)
P	Low-carbon steel Soft steel Niedrig legierter Kohlenstoffstahl Baustahl	≤180	YBG202 YBG205	190 (140-250)	0.08 (0.04-0.15)
	High-carbon steel Alloy steel Hoch leg. Kohlenstoffstahl	180-280	YBG202 YBG205	170 (130-250)	0.08 (0.04-0.15)
	Alloy tool steel Leg. Werkzeugstahl	280-350	YBG202 YBG205	150 (110-240)	0.08 (0.04-0.15)
M	Stainless steel Rostfreier Stahl	≤270	YBG202 YBG205	120 (80-190)	0.08 (0.04-0.15)
K	Cast iron Gusseisen	180-250	YBG202 YBG205	120 (80-210)	0.08 (0.04-0.15)

● Ex Stock / ab Lager ○ On demand / auf Anfrage

EMP13 *Kr:90°*

Achieving 90° with high quality Square Shoulder Milling Tools

Erreichen Sie 90° mit der neuen Eckfräserserie

The PVD coating of the tools leads to a longer tool life.

Eine PVD-Beschichtung auf dem Fräser erzielt eine höhere Lebensdauer der Trägerwerkzeuge.

Extra thick inserts with a positive soft cutting geometry reduces the cutting resistance and improves the wear resistance at the same time.

Extra dicke Wendeschneidplatte mit einer positiv weich schneidenden Geometrie reduziert den Schneidwiderstand bei gleichzeitiger Verbesserung der Bruchfestigkeit.

Maximum cutting depth:
Maximale Schnitttiefe:

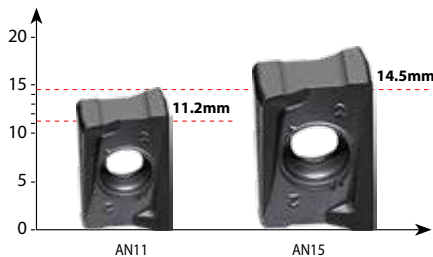

Specially designed cutting edges with high precision control can achieve high quality 90° square shoulder milling.

Speziell entwickelte Schneidkanten mit hoher Präzisionskontrolle für qualitativ hochwertiges 90° Eckfräser.

Example

Beispiel

Workpiece Material: Mold Steel(HRC36)
Werkstück Material: Gesenkstahl(HRC36)

Tool / Werkzeug: EMP13-032-G32-AN15-02

Inserts / WSP: ANGX150608PNR-GM/YBG205

cutting data: $V_c=220\text{m/min}$, $f_z=0.1\text{mm/z}$,
Schnittdaten: $a_p=14.5\text{mm}$, $a_e=10\text{mm}$

Cutting condition: Dry cutting
Schnittbedingungen: Trocken

Insert grades:
WSP Sorten:

YBM253	YB9320	YBG205	YBD152	YD101
CVD	PVD	PVD	CVD	-
P20 - P40	P10 - P30	P10 - P30	K05-K25	K05-K25
M10 - M30	M20 - M30	M20 - M30		

Comparison of Surface Quality:
Vergleich der Oberflächengüte:



EMP13

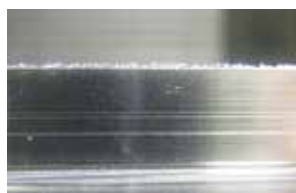

Wettbewerber A

The component machined by using EMP13 shows better surface quality and verticality than the similar products from company A.

Das Werkstück, das mit EMP13 bearbeitet wurde, weist eine bessere Oberflächengüte und – Vertikalität auf als nach der Bearbeitung mit einem ähnlichen Produkt vom Wettbewerber.

Square Shoulder Milling Tools · Eckfräser

Kr:90°



EMP13 P K

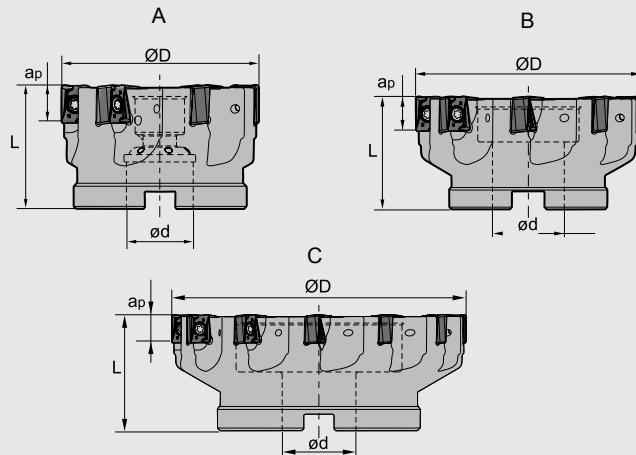

Specification of tools · Werkzeug Beschreibung

Type Typ	*	Stock Lager		Dimension (mm) Abmessung				No. of teeth Zähne	Coupling Aufnahme	Weight Gewicht (kg)
		R	L	ØD	Ød	L	apmax			
EMP13	-050-A22-AN11-06	●		50	22	40	11.2	6	A	0.30
	-063-A22-AN11-07	●		63	22	40	11.2	7	A	0.49
	-080-A27-AN11-09	●		80	27	50	11.2	9	A	1.18
	-100-B32-AN11-12	●		100	32	50	11.2	12	B	1.46
	-100-B32-AN11-12C	* ●		100	32	50	11.2	12	B	1.46
	-125-B40-AN11-14	●		125	40	63	11.2	14	B	2.92
	-125-B40-AN11-14C	* ●		125	40	63	11.2	14	B	2.92
	-160-C40-AN11-16	●		160	40	63	11.2	16	C	4.30
EMP13	-050-A22-AN15-04	●		50	22	40	14.5	4	A	0.26
	-063-A22-AN15-05	●		63	22	40	14.5	5	A	0.53
	-080-A27-AN15-06	●		80	27	50	14.5	6	A	1.23
	-100-B32-AN15-08	●		100	32	50	14.5	8	B	1.52
	-100-B32-AN15-08C	* ●		100	32	50	14.5	8	B	1.52
	-125-B40-AN15-10	●		125	40	63	14.5	10	B	3.05
	-125-B40-AN15-10C	* ●		125	40	63	14.5	10	B	3.05
	-160-C40-AN15-12	●		160	40	63	14.5	12	C	4.46
-200-C60-AN15-16	●		200	60	63	14.5	16	C	6.26	

Spare Parts · Ersatzteile

Diameter Durchmesser Ø D	Insert WSP	Screw Schraube	Drehmoment Torque	Wrench Schlüssel
Ø50-Ø160	ANGX110504PNR-**	I60M3X9	2 Nm	WT09IS
	ANGX110508PNR-**			
Ø50-Ø200	ANGX150608PNR-**	I60M4X12	3 Nm	WT15IS
	ANGX150616PNR-**			

We recommend to use torque wrenches · Wir empfehlen den Einsatz von Drehmomentschlüsseln

Coupling Aufnahme	Diameter Durchmesser Ø D	Screw·Schraube	Ring·Dichtring
B32	Ø100	LDB32C	B32-002-CP
B40	Ø125	LDB40C	B40-002-CP

● Ex Stock / ab Lager ○ On demand / auf Anfrage * With internal cooling · Mit Innenkühlung

Square Shoulder Milling Tools · Eckfräser

Kr:90°

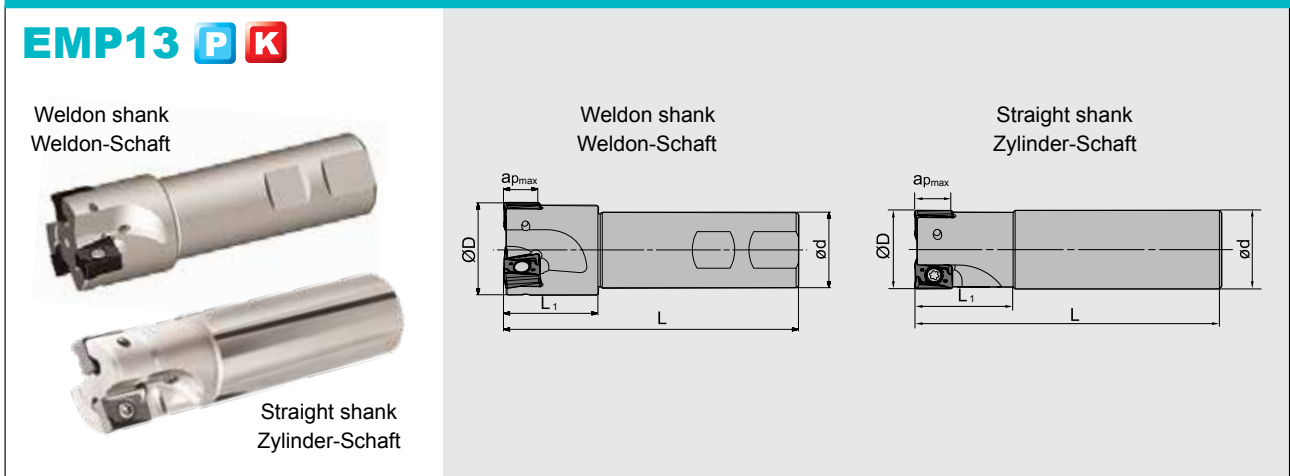

Specification of tools · Werkzeug Beschreibung

Type Typ	*	Stock Lager		Dimension (mm) Abmessung					No. of teeth Zähne	Weight Gewicht (kg)	
		R	L	ØD	Ød	L	L ₁	a _{pmax}			
Weldon shank Weldon- Schaft	EMP13 -025-XP25-AN11-02	*	●		25	25	100	32	11.2	2	0.31
	-032-XP32-AN11-03	*	●		32	32	115	40	11.2	3	0.61
	-040-XP32-AN11-04	*	●		40	32	125	40	11.2	4	0.75
	-032-XP32-AN15-02	*	●		32	32	125	40	11.2	2	0.66
	-040-XP32-AN15-03	*	●		40	32	125	40	11.2	3	0.76
Straight shank Zylinder- Schaft	EMP13 -025-G25-AN11-02	*	●		25	25	100	32	11.2	2	0.31
	-032-G32-AN11-03	*	●		32	32	115	40	11.2	3	0.61
	-040-G32-AN11-04	*	●		40	32	125	40	11.2	4	0.75
	-032-G32-AN15-02	*	●		32	32	125	40	14.5	2	0.66
	-040-G32-AN15-03	*	●		40	32	125	40	14.5	3	0.76

● Ex stock / ab Lager ○ On demand / auf Anfrage * With internal cooling · Mit Innenkühlung

Spare Parts · Ersatzteile

Diameter Durchmesser Ø D	Insert WSP	Screw Schraube	Drehmoment Torque	Wrench Schlüssel
Ø25-Ø40	ANGX110504PNR-**	I60M3X9	2 Nm	WT09IS
	ANGX110508PNR-**			
Ø32-Ø40	ANGX150608PNR-**	I60M4X12	3 Nm	WT15IS
	ANGX150616PNR-**			

We recommend to use torque wrenches · Wir empfehlen den Einsatz von Drehmomentschlüsseln

Applicable tool
Werkzeug

B11-B18

Tools code key
Werkzeug ISO

B26-B27

Grade selection guide
Sortenauswahl

B19-B23

Technical data
Technische Daten

B236-B241

Square Shoulder Milling Tools · Eckfräser

Kr:90°





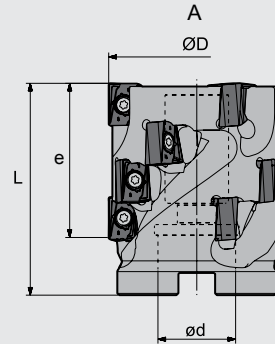



EMP13 P K



Specification of tools · Werkzeug Beschreibung

Type Typ	Stock Lager	Dimension (mm) Abmessung				No. of flutes Zähne	No. of inserts WSP Anzahl	Mounting style Aufnahme	Weight Gewicht (kg)		
		R	L	ØD	Ød						
EMP13 -050X43-A22-AN11-03	●			50	22	60	43	3	12	A	0.52
-063X64-A27-AN11-04	○			63	27	80	64	4	24	A	1.15
-063X53-A27-AN15-03	●			63	27	75	53	3	12	A	1.14
-080X53-A32-AN15-04	●			80	32	75	53	4	16	A	1.82

Spare Parts · Ersatzteile

Diameter Durchmesser Ø D	Insert WSP	Screw Schraube	Drehmoment Torque	Wrench Schlüssel
Ø50-Ø63	 ANGX110504PNR-**	 I60M3X9	2 Nm	 WT09IS
Ø63-Ø80	 ANGX150608PNR-**	 I60M4X12	3 Nm	 WT15IS



We recommend to use torque wrenches · Wir empfehlen den Einsatz von Drehmomentschlüsseln

● Ex Stock / ab Lager ○ On demand / auf Anfrage

Square Shoulder Milling Tools · Eckfräser

Kr:90°



EMP13 P K

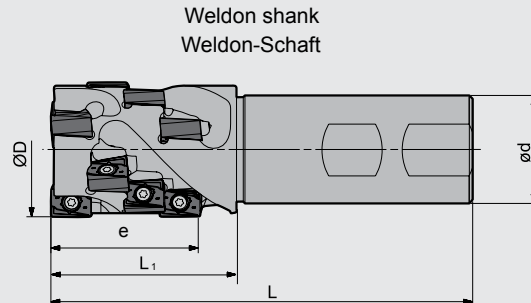

■ Specification of tools · Werkzeug Beschreibung

Type Typ	Stock Lager	Dimension (mm) Abmessung						No. of flutes Zähne	No. of inserts WSP Anzahl	Weight Gewicht (kg)	
		R	L	ØD	Ød	L	L ₁				e
EMP13 -032X43-XP32-AN11-02	●			32	32	115	48	43	2	8	0.61
-040X43-XP32-AN11-03	●			40	32	125	55	43	3	12	0.79
-040X40-XP32-AN15-02	●			40	32	115	55	40	2	6	0.79
-050X53-XP40-AN15-02	●			50	40	145	70	53	2	8	1.53

■ Spare Parts · Ersatzteile

Diameter Durchmesser Ø D	Insert WSP	Screw Schraube	Drehmoment Torque	Wrench Schlüssel	
Ø32-Ø40	ANGX110504PNR-**	I60M3X9	2 Nm	WT09IS	
Ø40-Ø50	ANGX150608PNR-**	I60M4X12	3 Nm	WT15IS	

We recommend to use torque wrenches · Wir empfehlen den Einsatz von Drehmomentschlüsseln

Applicable tool
Werkzeug **B11-B18**

Tools code key
Werkzeug ISO **B26-B27**

Grade selection guide
Sortenauswahl **B19-B23**

Technical data
Technische Daten **B236-B241**

Milling · Fräsen

Indexable Milling · Fräswendelplatten

Applicable inserts · Wendeschneidplatten

● Ideal Machining Condition / Gute Bearbeitungsbedingungen
● Normal Machining Condition / Normale Bearbeitungsbedingungen
● Unfavorable Machining Condition / Ungünstige Bearbeitungsbedingungen

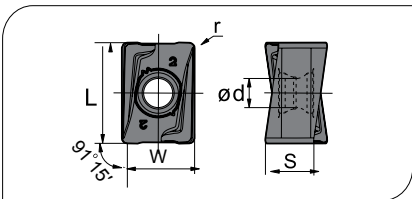

Workpiece Material / Werkstoff	P	M	K	N	S	YBC302	YBC301	YBC401	YBM253	YBM251	YBM351	YBD152	YBD252	YBG102	YBG320	YBG205	YBG202	YBG212	YBG302	YBG152	YBG252	YNG151	YNG151C	YC30S	YD101	YD201
P Steel / Stahl	●	●	●	●	●	●	●	●	●	●	●	●	●	●	●	●	●	●	●	●	●	●	●	●	●	●
M Stainless Steel / Rostfreier Stahl	●	●	●	●	●	●	●	●	●	●	●	●	●	●	●	●	●	●	●	●	●	●	●	●	●	●
K Cast iron / Gusseisen	●	●	●	●	●	●	●	●	●	●	●	●	●	●	●	●	●	●	●	●	●	●	●	●	●	●
N Non-ferrous material / NE-Metalle	●	●	●	●	●	●	●	●	●	●	●	●	●	●	●	●	●	●	●	●	●	●	●	●	●	●
S Heat-resistant steel / Warmfester Stahl	●	●	●	●	●	●	●	●	●	●	●	●	●	●	●	●	●	●	●	●	●	●	●	●	●	●

Insert shape / Plattenform	Type / Typ	Dimension (mm) / Abmessung					CVD Coating / CVD Beschicht.						PVD Coating / PVD Beschicht.					Cermets / Cermet	Carbide uncoat. / unbe. Hartmetall									
		L	W	S	Ød	r	YBC302	YBC301	YBC401	YBM253	YBM251	YBM351	YBD152	YBD252	YBG102	YBG320	YBG205		YBG202	YBG212	YBG302	YBG152	YBG252	YNG151	YNG151C	YC30S	YD101	YD201
	ANGX110504PNR-GM	11.85	8.4	5.7	3.5	0.8				●			●		●	●												
	ANGX110508PNR-GM	11.85	8.4	5.7	3.5	0.4	○			●			●	●	●	●												
	ANGX150608PNR-GM	15.43	11.0	7.3	4.4	0.8	○			●			●	●	●	●												
	ANGX150616PNR-GM	15.43	11.0	7.3	4.4	1.6				●			●				●											
	ANGX150620PNR-GM	15.43	11.0	7.3	4.4	2.0				●			●	●			●											
	ANGX110504PNR-LH	11.85	8.4	5.7	3.5	0.8																				●		
	ANGX150608PNR-LH	15.43	11.0	7.3	4.4	0.8																				●		

Recommended cutting data · Empfohlene Schnittdaten

Workpiece material / Werkstückstoff	Hardness HB / Härte	Grade / Sorte	Cutting data / Schnittdaten		
			V (m/min)	f (mm/z)	a _p max
P Low-carbon steel / Soft steel / Niederlegierter Kohlenstoffstahl	≤180	YBM253	270 (220-350)	0.25 (0.1-0.4)	11.2(AN11) 14.5(AN15)
		YBG205 YB9320			
K Alloy tool steel / Leg. Werkzeugstahl	180-350	YBM253	240 (180-320)	0.2 (0.1-0.4)	
		YBG205 YB9320			
K Cast iron / Gusseisen	180-250	YBD152	270 (150-300)	0.25 (0.1-0.4)	
N Al alloy / NE-Metalle	-	YD101	300	0.25 (0.1-0.4)	
		YD201	300	0.25 (0.1-0.4)	
		YBG101	400-700	0.25 (0.1-0.4)	

Mounting double side inserts:

Montage von doppelseitigen Wendeschneidplatten bei Fräsern:



Please make sure that the faces with same marks are in the same direction.

Bitte stellen Sie sicher, dass die Platten mit derselben Markierung in dieselbe Richtung angebracht werden.

● Ex Stock / ab Lager ○ On demand / auf Anfrage

Profile milling tools · Profilfräser

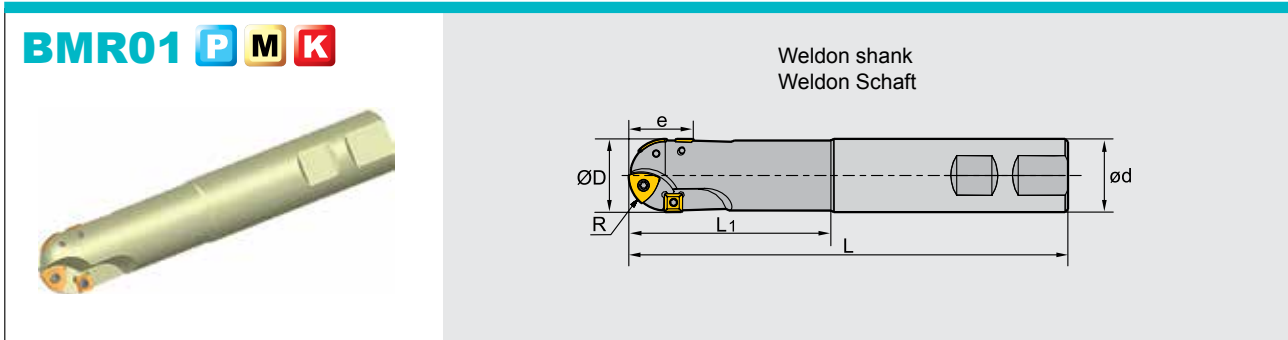

Specification of tools · Werkzeug Beschreibung

Type Typ	Stock Lager	Dimensions (mm) Abmessungen						Inserts WSP				Weight Gewicht (kg)
		R	Ø D	e	ø d	L	L ₁	Type Typ	Quantity Anzahl	Type Typ	Quantity Anzahl	
BMR01	○	10	20	20	20	125	50	ZDET08T2CYR10	2	SPMT060304	2	0.3
	○	10	20	20	20	150	75	ZDET08T2CYR10	2	SPMT060304	2	0.3
	○	10	20	20	20	200	100	ZDET08T2CYR10	2	SPMT060304	2	0.4
	○	12.5	25	23	25	150	70	ZDET1103CYR12.5	2	SPMT060304	2	0.5
	○	12.5	25	23	25	175	95	ZDET1103CYR12.5	2	SPMT060304	2	0.6
	○	12.5	25	23	25	200	100	ZDET1103CYR12.5	2	SPMT060304	2	0.7
	○	16	32	31	32	175	85	ZDET13T3CYR16	2	SDMT090308	2	0.9
	○	16	32	31	32	200	100	ZDET13T3CYR16	2	SDMT090308	2	1.1
	○	16	32	31	32	250	150	ZDET13T3CYR16	2	SDMT090308	2	1.4
	○	20	40	41	40	175	85	ZPNT2204CY(R20)	3	SPMT120408	2	1.4
	○	20	40	41	40	200	100	ZPNT2204CY(R20)	3	SPMT120408	2	1.7
	○	20	40	41	40	250	150	ZPNT2204CY(R20)	3	SPMT120408	2	2.1
	○	25	50	45	40	200	100	ZPNT2204CY(R25)	3	SPMT120408	2	1.8
	○	25	50	45	40	300	100	ZPNT2204CY(R25)	3	SPMT120408	2	2.8
	○	31.5	63	52	40	200	100	ZPNT2204CY(R31)	4	SPMT120408	2	3.0
	○	31.5	63	52	40	300	100	ZPNT2204CY(R31)	4	SPMT120408	2	3.5

● Ex Stock / ab Lager ○ On demand / auf Anfrage

Spare parts · Ersatzteile

Diameter Durchmesser Ø D	Screw Schraube	Wrench Schlüssel	
	Ø20-Ø25	I43M2.5×5.7	WT07IP
Ø32	I43M4×8	--	WT15IS
Ø40-Ø63	I43M5×11	--	WT20IS



Applicable tool
Werkzeug **B11-B18**

Tools code key
Werkzeug ISO **B26-B27**

Grade selection guide
Sortenauswahl **B19-B23**

Technical data
Technische Daten **B236-B241**

Milling - Fräsen

Indexable Milling - Fräswendepplatten

Applicable inserts · Wendeschneidplatten

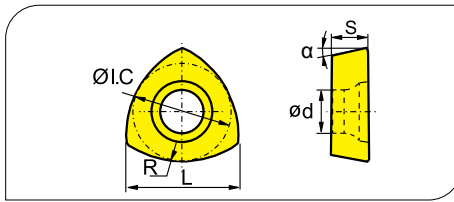

Workpiece Material Werkstoffe	Ideal Machining Condition Gute Bearbeitungsbedingungen			Normal Machining Condition Normale Bearbeitungsbedingungen			Unfavorable Machining Condition Ungünstige Bearbeitungsbedingungen								
	P	M	K	N	S	P	M	K	N	S	P	M	K	N	S
P Steel Stahl	●	●	●	●	●	●	●	●	●	●	●	●	●	●	●
M Stainless Steel Rostfreier Stahl	●	●	●	●	●	●	●	●	●	●	●	●	●	●	●
K Cast iron Gusseisen	●	●	●	●	●	●	●	●	●	●	●	●	●	●	●
N Non-ferrous material Nichte Metalle	●	●	●	●	●	●	●	●	●	●	●	●	●	●	●
S Heat-resistant steel Warmfester Stahl	●	●	●	●	●	●	●	●	●	●	●	●	●	●	●

Insert WSP	Type Typ	Dimensions (mm) Abmessungen						CVD Coating CVD Beschicht.						PVD Coating PVD Beschicht.						Cermet Cermet	Carbide uncoat. unbe. Hartmetall												
		R	L	I.C.	S	d	α	YBC302	YBC301	YBC401	YBM253	YBM251	YBM351	YBD152	YBD252	YBG102	YBG320	YBG205	YBG202		YBG212	YBG302	YBG152	YBG252	YNG151	YNG151C	YC30S	YD101	YD201				
	ZDET08T2CYR10	10	8.4	6.75	2.78	2.8	14°					●																					
	ZDET1103CYR12.5	12.5	10.6	8.5	3.18	2.8	14°					○																					
	ZDET13T3CYR16	16	13.2	10.5	3.97	4.4	14°					●								●													
	ZPNT2204CY(R20)	20	16.1	12.7	4.76	5.56	11°					●																					
	ZPNT2204CY(R25)	25	16.9	12.7	4.76	5.56	11°					●																					
	ZPNT2204CY(R31)	31.5	17.6	12.7	4.76	5.56	11°					●																					

Applicable inserts · Wendeschneidplatten

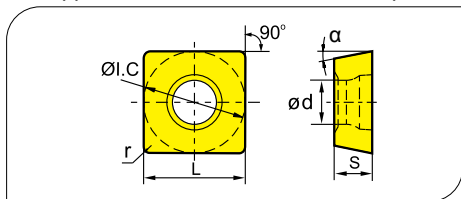

Workpiece Material Werkstoffe	Ideal Machining Condition Gute Bearbeitungsbedingungen			Normal Machining Condition Normale Bearbeitungsbedingungen			Unfavorable Machining Condition Ungünstige Bearbeitungsbedingungen								
	P	M	K	N	S	P	M	K	N	S	P	M	K	N	S
P Steel Stahl	●	●	●	●	●	●	●	●	●	●	●	●	●	●	●
M Stainless Steel Rostfreier Stahl	●	●	●	●	●	●	●	●	●	●	●	●	●	●	●
K Cast iron Gusseisen	●	●	●	●	●	●	●	●	●	●	●	●	●	●	●
N Non-ferrous material Nichte Metalle	●	●	●	●	●	●	●	●	●	●	●	●	●	●	●
S Heat-resistant steel Warmfester Stahl	●	●	●	●	●	●	●	●	●	●	●	●	●	●	●

Insert WSP	Type Typ	Dimensions (mm) Abmessungen						CVD Coating CVD Beschicht.						PVD Coating PVD Beschicht.						Cermet Cermet	Carbide uncoat. unbe. Hartmetall												
		r	L	I.C.	S	d	α	YBC302	YBC301	YBC401	YBM253	YBM251	YBM351	YBD152	YBD252	YBG102	YBG320	YBG205	YBG202		YBG212	YBG302	YBG152	YBG252	YNG151	YNG151C	YC30S	YD101	YD201				
	SPMT060304	0.4	6.35	6.35	3.18	2.8	11°					●																					
	SDMT090308	0.8	9.525	9.525	3.18	4.4	15°					●	●																				
	SPMT120408	0.8	12.7	12.70	4.76	5.5	11°	●	●			●	●									●											

Recommended Cutting data · Schnittdaten

Workpiece material Werkstückstoff	Hardness HB Härte	Grade Sorte	Cutting data Schnittdaten	
			V(m/min)	f(mm/z)
P Low-carbon steel Soft steel Niedriglegierter Kohlenstoffstahl Baustahl	≤180	YBM251	180(120-220)	0.25(0.1-0.4)
		YBC301		
		YBG302	160(120-220)	0.25(0.1-0.4)
	YBC401			
	YBM251			
	180-280	YBC301	150(100-200)	0.2(0.1-0.4)
YBG302		120(100-200)	0.2(0.1-0.4)	
YBC401				
280-350	YBM251	100(80-150)	0.2(0.1-0.3)	
	YBC301	100(80-150)	0.2(0.1-0.3)	
	YBG302			
M Stainless steel Rostfreier Stahl	≤270	YBM251	100(80-150)	0.2(0.1-0.3)
		YBG302	100(80-150)	0.2(0.1-0.3)
K Cast iron Gusseisen	180-250	YBM251	150(100-180)	0.3(0.2-0.5)

● Ex Stock / ab Lager ○ On demand / auf Anfrage



Profile milling tools · Profilfräser

BMR02 P M K

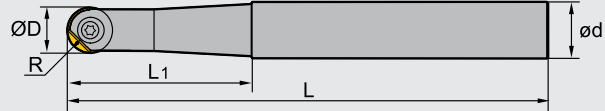

■ Specification of tools · Werkzeug Beschreibung

	Type Typ	Stock Lager	Dimensions (mm) Abmessungen					Weight Gewicht (kg)
			R	Ø D	ø d	L	L ₁	
BMR02	-012-G16-S	●	6	12	16	110	40	0.1
	-012-G16-M	●	6	12	16	130	50	0.2
	-012-G16-L	●	6	12	16	160	50	0.2
	-016-G20-S	●	8	16	20	140	45	0.3
	-016-G20-M	●	8	16	20	170	65	0.3
	-016-G20-L	●	8	16	20	200	65	0.4
	-020-G25-S	●	10	20	25	160	60	0.5
	-020-G25-M	●	10	20	25	200	80	0.6
	-020-G25-L	●	10	20	25	240	80	0.8

■ Spare parts · Ersatzteile

Diameter Durchmesser Ø D	Screw Schraube	Wrench Schlüssel
Ø12	I70M4×10TT	WT10S
Ø16	I70M5×12TT	WT15S
Ø20	I70M5×16TT	WT15S



Applicable tool B11-B18
Werkzeug

Tools code key B26-B27
Werkzeug ISO

Grade selection guide B19-B23
Sortenauswahl

Technical data B236-B241
Technische Daten

Milling - Fräsen

Indexable Milling - Fräswendepetten

Applicable inserts · Wendeschneidplatten

Workpiece Material Werkstoffe	P Steel Stahl	M Stainless Steel Rostfreier Stahl	K Cast iron Gusseisen	N Non-ferrous material Nietmetalle	S Heat-resistant steel Wärmefester Stahl	Ideal Maching Condition Gute Bearbeitungsbedingungen	Normal Maching Condition Normale Bearbeitungsbedingungen	Unfavorable Maching Condition Ungünstige Bearbeitungsbedingungen
	●	●	●	●	●	●	●	●
	●	●	●	●	●	●	●	●
	●	●	●	●	●	●	●	●
	●	●	●	●	●	●	●	●
	●	●	●	●	●	●	●	●
	●	●	●	●	●	●	●	●
	●	●	●	●	●	●	●	●
	●	●	●	●	●	●	●	●
	●	●	●	●	●	●	●	●
	●	●	●	●	●	●	●	●

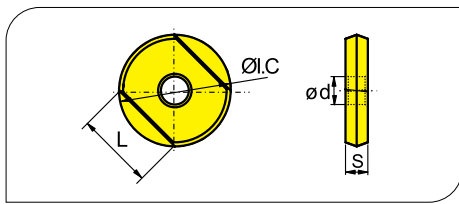

Insert WSP	Type Typ	Dimensions (mm) Abmessungen					CVD Coating CVD Beschicht.					PVD Coating PVD Beschicht.					Cermet Cermet	Carbide uncoat. unbe. Hartmetall														
		I.C	L	S	d	Applicable tools Entsprechendes Werkzeug	YBC302	YBC301	YBC401	YBM253	YBM251	YBM351	YBD152	YBD252	YBG102	YB9320		YBG205	YBG202	YBG212	YBG302	YBG152	YBG252	YNG151	YNG151C	YC30S	YD101	YD201				
	ROHX1203	12	8.5	3	4	Φ12									○	●							●									
	ROHX1604	16	11.3	4	5	Φ16											●						●									
	ROHX2005	20	14.1	5	5	Φ20											●						●									

Recommended Cutting data · Schnittdaten

Workpiece material Werkstückstoff	Hardness HB Härte	Grade Sorte	Cutting data Schnittdaten	Diameter Durchmesser Ø D					
				Ø12	Ø16	Ø20			
P	carbon steel leg. Kohlenstoffstahl	HB≤180	V(m/min)	100~200	100~200	100~200			
			f _z (mm/z)	0.15~0.25	0.2~0.3	0.2~0.3			
			a _{pmax} (mm)	0.8	1	1.25			
	Alloy steel Leg. Stahl	HB180~280	V(m/min)	80~180	80~180	80~180			
			f _z (mm/z)	0.15~0.25	0.2~0.3	0.2~0.3			
			a _{pmax} (mm)	0.8	1	1.25			
	Hardened steel gehärteter Stahl	HRC55~65	YBG202	V(m/min)	60~100	60~100	60~100		
			YBG252	f _z (mm/z)	0.15~0.25	0.2~0.3	0.2~0.3		
			a _{pmax} (mm)	0.4	0.5	0.6			
	M	Stainless steel Rostfreier Stahl	HB≤270	V(m/min)	70~150	70~150	70~150		
				f _z (mm/z)	0.1~0.2	0.1~0.25	0.1~0.25		
				a _{pmax} (mm)	0.6	0.8	1		
a _{emax} (mm)				0.6	0.8	1			
K				Cast iron Gusseisen	HB180-250	V(m/min)	160~300	160~300	160~300
						f _z (mm/z)	0.2~0.3	0.25~0.35	0.25~0.35
	a _{pmax} (mm)	1	1.5			1.8			
			a _{emax} (mm)	1	1.5	1.8			

● Ex Stock / ab Lager ○ On demand / auf Anfrage



Profile milling tools · Profilfräser

BMR03 P M K



Straight shank
Zylinder Schaft

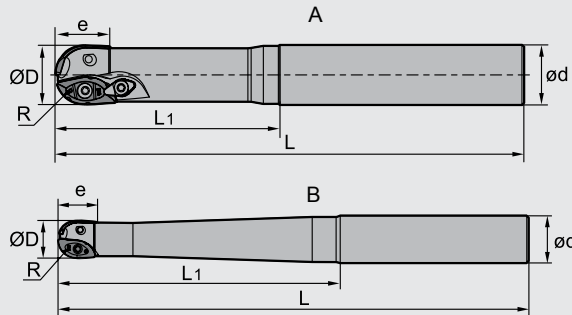

Specification of tools · Werkzeug Beschreibung

Type Typ	Stock Lager	Dimensions (mm) Abmessungen						No. of teeth Zähne	Weight Gewicht (kg)	Type Typ	Clamp Pratze	
		R	Ø D	ø d	L	L ₁	e					
BMR03	-016-G20-S	●	8	16	20	150	70	16	2	0.3	B	
	-016-G20-M	●	8	16	20	180	80	16	2	0.4	B	
	-020-G25-S	●	10	20	25	180	80	20	2	0.5	B	
	-020-G25-M	●	10	20	25	200	100	20	2	0.6	B	
	-020-G25-L	●	10	20	25	250	150	20	2	0.7	B	
	-020-G25-XL	○	10	20	25	300	110	20	2	1.0	B	
	-025-G25-S	●	12.5	25	25	180	80	25	2	0.6	B	
	-025-G25-M	●	12.5	25	25	200	100	25	2	0.7	B	
	-025-G25-L	○	12.5	25	25	250	110	25	2	0.8	B	
	-025-G25-XL	○	12.5	25	25	300	120	25	2	1.0	B	
	-030-G32-S	○	15	30	32	200	120	30	2	1.0	A	WD-208
	-030-G32-M	●	15	30	32	250	150	30	2	1.3	A	
	-030-G32-L	○	15	30	32	300	200	30	2	1.6	A	
	-030-G32-XL	○	15	30	32	350	200	30	2	1.9	A	
	-032-G32-S	●	16	32	32	200	120	32	2	1.1	A	
	-032-G32-M	●	16	32	32	250	150	32	2	1.4	A	
	-032-G32-L	●	16	32	32	300	200	32	2	1.6	A	
	-032-G32-XL	○	16	32	32	350	200	32	2	2.0	A	
	-040-G40-S	○	20	40	40	200	120	40	2	1.6	A	CBH5R1
	-040-G40-M	○	20	40	40	250	150	40	2	2.0	A	
	-040-G40-L	●	20	40	40	300	200	40	2	2.5	A	
	-040-G40-XL	○	20	40	40	350	200	40	2	3.0	A	

Applicable tool
Werkzeug

B11-B18

Tools code key
Werkzeug ISO

B26-B27

Grade selection guide
Sortenauswahl

B19-B23

Technical data
Technische Daten

B236-B241

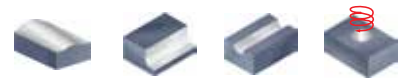

Profile milling tools · Profilfräser

BMR03 P M K

A (Ø30-Ø50)



B (Ø16-Ø25)

Weld on shank
Weld on shaft

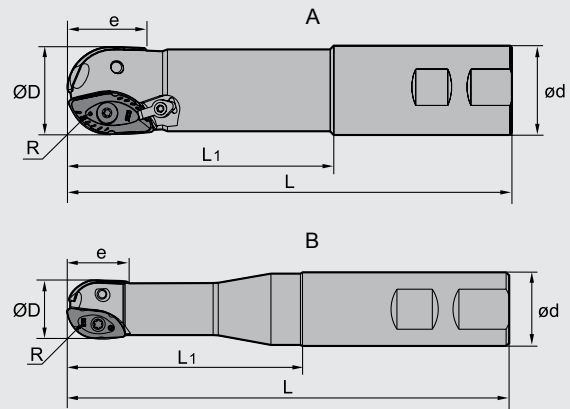

Specification of tools · Werkzeug Beschreibung

	Type Typ	Stock Lager	Dimensions (mm) Abmessungen						No. of teeth Zähne	Weight Gewicht (kg)	Type Typ	Clamp Pratze
			R	Ø D	ø d	L	L ₁	e				
BMR03	-016-XP20-M	●	8	16	20	111	60	16	2	0.2	B	
	-020-XP25-M	●	10	20	25	127	70	20	2	0.3	B	
	-020-XP25-L	●	10	20	25	150	80	20	2	0.4	B	
	-025-XP25-M	●	12.5	25	25	137	80	25	2	0.4	B	
	-025-XP25-L	●	12.5	25	25	200	100	25	2	0.6	B	
	-030-XP32-M	●	15	30	32	161	100	30	2	0.8	A	
	-030-XP32-L	●	15	30	32	250	150	30	2	1.3	A	WD-208
	-032-XP32-M	●	16	32	32	161	100	32	2	0.8	A	
	-032-XP32-L	○	16	32	32	250	120	32	2	1.3	A	
	-040-XP40-M	○	20	40	40	175	100	40	2	1.3	A	CBH5R1
	-040-XP40-L	●	20	40	40	250	120	40	2	2.0	A	
	-050-XP50-M	○	25	50	50	200	100	50	2	2.5	A	
-050-XP50-L	○	25	50	50	250	150	50	2	3.1	A		

● Ex Stock / ab Lager ○ On demand / auf Anfrage



Profile milling tools · Profilfräser

BMR03 P M K

A (Ø30-Ø50)



B (Ø20-Ø25)

Morse taper shank
Morsekegel Schaft

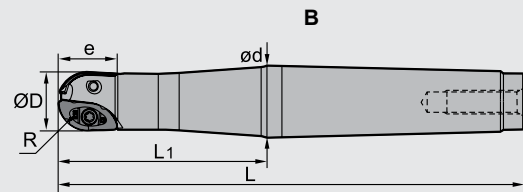
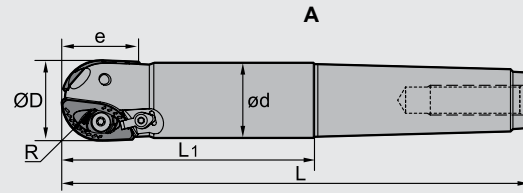

Specification of tools · Werkzeug Beschreibung

Type Typ	Stock Lager	Dimensions (mm) Abmessungen							No. of teeth Zähne	Weight Gewicht (kg)	type typ	Clamp Pratze
		R	Ø D	ø d	L	L1	e					
BMR03	-020-MT3-M	○	10	20	18.7	156	70	20	2	0.4	B	WD-208
	-020-MT3-L	○	10	20	18.7	186	100	20	2	0.4	B	
	-025-MT3-M	○	12.5	25	23.5	156	70	25	2	0.4	B	
	-025-MT3-L	○	12.5	25	23.5	186	100	25	2	0.4	B	
	-030-MT4-M	○	15	30	28.2	189	70	30	2	0.8	A	WD-208
	-030-MT4-L	○	15	30	28.2	229	120	30	2	1.0	A	
	-032-MT4-M	○	16	32	29.2	179	70	32	2	0.9	A	
	-032-MT4-L	●	16	32	29.2	209	100	32	2	0.9	A	
	-040-MT4-M	○	20	40	36.9	199	100	40	2	1.0	A	CBH5R1
	-040-MT5-L	○	20	40	36.9	226	90	40	2	1.8	A	
	-040-MT5-XL	○	20	40	36.9	256	120	40	2	2.0	A	
	-050-MT5-M	●	25	50	46.8	236	100	50	2	2.2	A	
-050-MT5-L	○	25	50	46.8	286	150	50	2	2.9	A		

Applicable tool
Werkzeug

[B11-B18](#)

Tools code key
Werkzeug ISO

[B26-B27](#)

Grade selection guide
Sortenauswahl

[B19-B23](#)

Technical data
Technische Daten

[B236-B241](#)



Profile milling tools · Profilfräser

BMR03 P M K

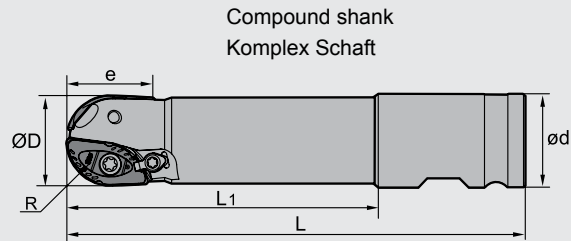

Specification of tools · Werkzeug Beschreibung

Type Typ	Stock Lager	Dimensions (mm) Abmessungen							No. of teeth Zähne	Weight Gewicht (kg)	Clamp Pratze
		R	Ø D	ø d	L	L ₁	e				
BMR03	-040-XPX-M	○	20	40	50.8	250	170	40	2	1.3	CBH5R1
	-040-XPX-L	○	20	40	50.8	300	220	40	2	3.1	
	-040-XPX-XL	○	20	40	50.8	350	270	40	2	3.5	
	-050-XPX-M	○	25	50	50.8	250	170	50	2	3.1	
	-050-XPX-L	○	25	50	50.8	300	200	50	2	3.8	
	-050-XPX-XL	○	25	50	50.8	350	270	50	2	4.4	

Spare parts · Ersatzteile

Diameter Durchmesser Ø D	Clamp Pratze	Screw Schraube	Wrench Schlüssel	
Φ16	--	I60M2.5×6.5	--	WT07P
Φ20	--	I60M3.5×08TT	--	WT10IP
Φ25	--	I60M4×10	--	WT15S
Φ30	WD-208	I60M5×13	WT20IT	--
Φ32	WD-208	I60M5×13	WT20IT	--
Φ40	CBH5R1	I43M6×16	WT25IT	--
Φ50	CBH5R1	I43M8×21	WT25IT	--
		I43M6×16	WT30IT	--



● Ex Stock / ab Lager ○ On demand / auf Anfrage

Milling · Fräsen

Indexable Milling · Fräswendeplatten

■ Applicable inserts · Wendeschneidplatten

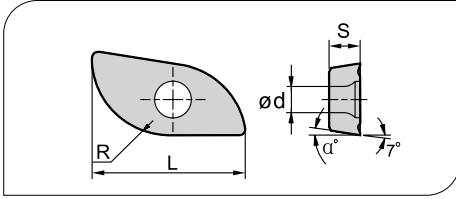

Workpiece Material Werkstoffe	Ideal Machining Condition Gute Bearbeitungsbedingungen			Normal Machining Condition Normale Bearbeitungsbedingungen			Unfavorable Machining Condition Ungünstige Bearbeitungsbedingungen		
	P	M	K	P	M	K	P	M	K
P Steel Stahl	●	●	●	●	●	●	●	●	●
M Stainless Steel Rostfreier Stahl	●	●	●	●	●	●	●	●	●
K Cast iron Gusseisen							●	●	●
N Non-ferrous material Nichtmetalle									●
S Heat-resistant steel Warmfester Stahl							●	●	●

Insert WSP	Type Typ	Dimensions (mm) Abmessungen					Applicable tools Entsprechendes Werkzeug	CVD Coating CVD Beschicht.							PVD Coating PVD Beschicht.				Cermet Cermet	Carbide uncoat. unbe. Hartmetall							
		R	d	S	α°	L		YBC302	YBC301	YBC401	YBM253	YBM251	YBM351	YBD152	YBD252	YBG102	YBG320	YBG205			YBG202	YBG212	YBG302	YBG152	YBG252	YNG151	YNG151C
	XPHT16R0803-GM	8	3.1	3.18	9	16	Φ16													●							
	XPHT20R10T3-GM	10	4.0	3.97	9	20	Φ20													●							
	XPHT25R1204-GM	12.5	4.7	4.76	9	25	Φ25													●							
	XPHT30R1506-GM	15	5.8	6.35	11	30	Φ30													●							
	XPHT32R1606-GM	16	5.8	6.35	9	32	Φ32													●							
	XPHT40R2007-GM	20	6.8	7.94	9	40	Φ40													●							
	XPHT50R2507-GM	25	9.2	7.94	9	50	Φ50													●							

B

Milling Tools
Fräser



BMR03



Ball nose end mills - Serie - Kugelschaftfräser

- The unique chipbreaker design and big rake angle can effectively control the curling and flow direction of chippings and reduce the cutting force, improve workpiece surface quality and tool life.
 - The insert after precisely grinding periphery and locating surface can sufficiently ensure the shape accuracy of cutting edge and the precision of location and installation, improve the reliability of installation and the workpiece precision after machining.
 - The concave structure design of flank can effectively enhance the strength of cutting edge, and prevent the scraping between the clearance face and workpiece surface. Therefore it improves the workpiece surface quality and prolongs the life of insert.
 - The design of cutting edge over center and a big negative rake angle make it possible to cut vertically, thus the capability of anti-breakage is enhanced.
 - The rough ball nose milling cutters with big diameter adopt the top and hole clamping style, insert clamping becomes more firm and stable. The machining also is high efficiency even at the poor condition such as long overhang and large vibration etc.
 - The adapter types include straight shank, Weldon shank, Morse taper shank and compound shank.
-
- Das einzigartige Spanbrecherdesign mit großem Spanwinkel, kontrolliert Spanbildung und Spanabfuhr, reduziert die Schnittkräfte und erhöht die Werkzeuglebensdauer.
 - Die umfangsgeschliffene Schneidplatte und die Präzision des Plattensitzes sind ein Garant für die Erzielung einer hohen Werkstückqualität.
 - Die konkave Schneidengeometrie erhöht die Schneidkantenstabilität und schützt die Schneide vor Ausbrüchen.
 - Die Ausführung der Zentrumsschneide und ein großer negativer Spanwinkel ermöglicht eine vertikale Bearbeitung (Zustellung) und stabilisiert das Werkzeug.
 - Der Schruppradiusfräser für größere Durchmesser ist neben der Schrauben- mit einer zusätzlichen Prattenklemmung versehen. Dadurch wird die Schneidplattenklemmung deutlich erhöht. Dies ermöglicht eine effizientere Bearbeitung auch unter ungünstigen Bedingungen, wie bei langer Auskragung oder Vibrationen.
 - Durch verschiedene Schaftausführungen kann das Werkzeugsystem auf unterschiedlichen Maschinen eingesetzt werden.

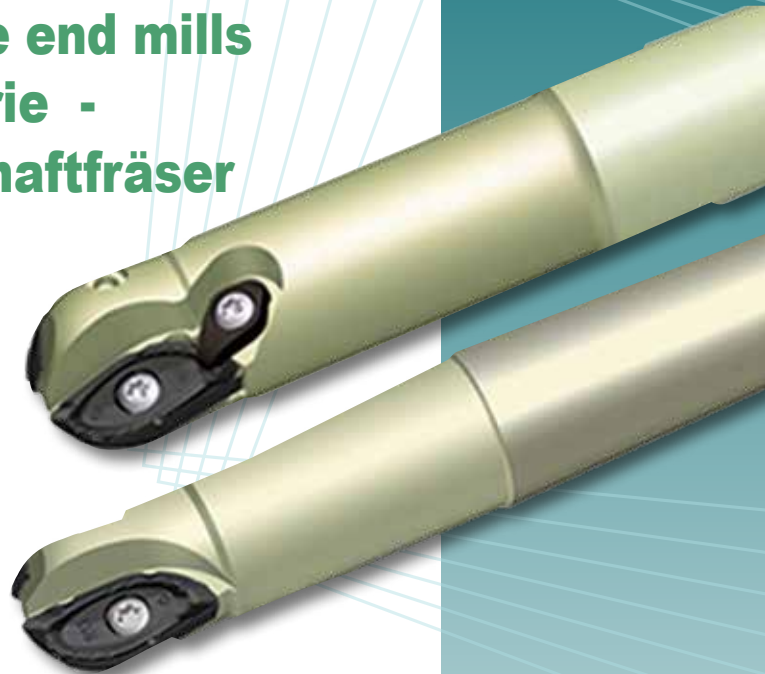

Slot shape after machining
Nut nach der Bearbeitung

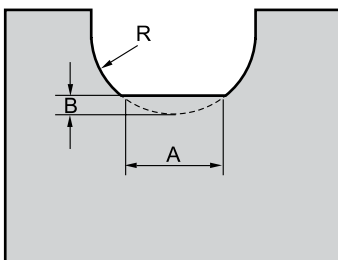

R	A	B
08	1.7	0.09
10	2.2	0.12
12.5	3.0	0.18
15	3.9	0.20
16	3.5	0.22
20	3.6	0.24
25	3.8	0.26

Diameter range
Durchmesser Bereich Ø16

Recommended Cutting data · Schnittdaten

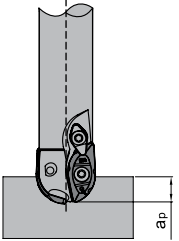
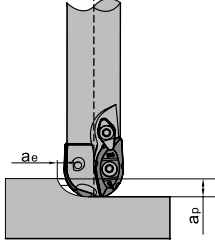
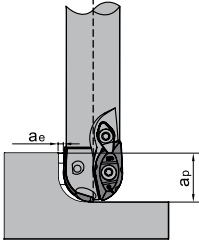
Operations Anwendung						
Workpiece material Werkstückstoff	Cutting data Schnittdaten	Machining of slot Nutenfräsen	Side milling (slight) Schulterfräsen		Side milling (deep) Schulterfräsen	Grade Sorte
Medium carbon steel Kohlenstoffstahl Hardness Härte 150~250HB	V(m/min)	150~220	150~220	150~220	150~220	YBG302
	Fz(mm/z)	0.1~0.4	0.1~0.4	0.1~0.4	0.1~0.4	
	a _p (mm)	4	4	8	16	
	a _e (mm)	--	3	4	1.5	
Alloy steel Leg. Stahl Hardness Härte 150~280HB	V(m/min)	100~150	100~150	100~150	100~150	
	Fz(mm/z)	0.1~0.4	0.1~0.4	0.1~0.4	0.1~0.4	
	a _p (mm)	4	4	8	16	
	a _e (mm)	--	3	4	1.5	
Die steel Gesenkstahl Hardness Härte 150~255HB	V(m/min)	80~120	80~120	80~120	80~120	
	Fz(mm/z)	0.1~0.3	0.1~0.3	0.1~0.3	0.1~0.3	
	a _p (mm)	4	4	8	16	
	a _e (mm)	--	3	4	1.5	
Hardened steel gehärteter Stahl Hardness Härte 40~50HRC	V(m/min)	80~100	80~100	80~100	--	
	Fz(mm/z)	0.08~0.15	0.08~0.15	0.08~0.15	--	
	a _p (mm)	4	4	8	--	
	a _e (mm)	--	2	3	--	
Grey Cast iron Grauguss Hardness Härte 160~260HB	V(m/min)	250~300	250~300	250~300	250~300	
	Fz(mm/z)	0.08~0.15	0.08~0.15	0.08~0.15	0.08~0.15	
	a _p (mm)	4	4	8	16	
	a _e (mm)	--	3	4	1.5	
Nodular Cast iron Kugelgrafitguss Hardness Härte 170~300HB	V(m/min)	200~250	200~250	200~250	200~250	
	Fz(mm/z)	0.08~0.15	0.08~0.15	0.08~0.15	0.08~0.15	
	a _p (mm)	4	4	8	16	
	a _e (mm)	--	3	4	1.5	

Milling · Fräsen

Indexable Milling Tools · Wendeplattenfräser

Diameter range Ø20

Durchmesser Bereich Ø20

■ Recommended Cutting data · Schnittdaten

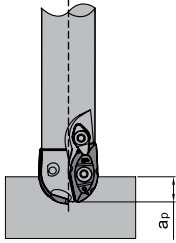
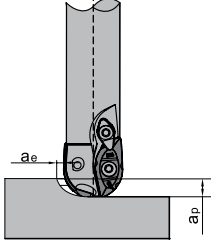
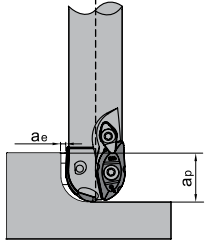
Operations Anwendung						
Workpiece material Werkstückstoff	Cutting data Schnittdaten	Machining of slot Nutenfräsen	Side milling (slight) Schulterfräsen		Side milling (deep) Schulterfräsen	Grade Sorte
Medium carbon steel Kohlenstoffstahl Hardness Härte 150~250HB	V(m/min)	150~220	150~220	150~220	150~220	YBG302
	Fz(mm/z)	0.1~0.4	0.1~0.4	0.1~0.4	0.1~0.4	
	a _p (mm)	5	5	10	20	
	a _e (mm)	--	4	5	2	
Alloy steel Leg. Stahl Hardness Härte 150~280HB	V(m/min)	100~150	100~150	100~150	100~150	
	Fz(mm/z)	0.1~0.4	0.1~0.4	0.1~0.4	0.1~0.4	
	a _p (mm)	5	5	10	20	
	a _e (mm)	--	4	5	2	
Die steel Gesenkstahl Hardness Härte 150~255HB	V(m/min)	80~120	80~120	80~120	80~120	
	Fz(mm/z)	0.1~0.3	0.1~0.3	0.1~0.3	0.1~0.3	
	a _p (mm)	5	5	10	20	
	a _e (mm)	--	4	5	2	
Hardened steel gehärteter Stahl Hardness Härte 40~50HRC	V(m/min)	80~100	80~100	80~100	--	
	Fz(mm/z)	0.08~0.15	0.08~0.15	0.08~0.15	--	
	a _p (mm)	5	5	10	--	
	a _e (mm)	--	4	5	--	
Grey Cast iron Grauguss Hardness Härte 160~260HB	V(m/min)	250~300	250~300	250~300	250~300	
	Fz(mm/z)	0.08~0.15	0.08~0.15	0.08~0.15	0.08~0.15	
	a _p (mm)	5	5	10	20	
	a _e (mm)	--	4	5	2	
Nodular Cast iron Kugelgraphitguss Hardness Härte 170~300HB	V(m/min)	200~250	200~250	200~250	200~250	
	Fz(mm/z)	0.08~0.15	0.08~0.15	0.08~0.15	0.08~0.15	
	a _p (mm)	5	5	10	20	
	a _e (mm)	--	4	5	2	

B

Milling Tools
Fräser

Diameter range
Durchmesser Bereich Ø25

Recommended Cutting data · Schnittdaten

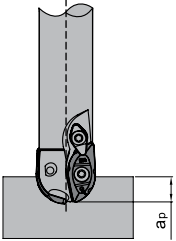
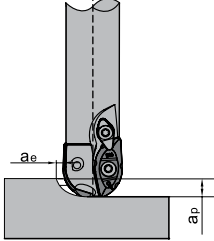
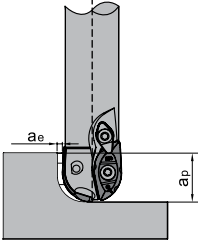
Operations Anwendung						
Workpiece material Werkstückstoff	Cutting data Schnittdaten	Machining of slot Nutenfräsen	Side milling (slight) Schulterfräsen		Side milling (deep) Schulterfräsen	Grade Sorte
Medium carbon steel Kohlenstoffstahl Hardness Härte 150~250HB	V(m/min)	150~220	150~220	150~220	150~220	YBG302
	Fz(mm/z)	0.1~0.4	0.1~0.4	0.1~0.4	0.1~0.4	
	a _p (mm)	6	6	12.5	25	
	a _e (mm)	--	5	6.5	3	
Alloy steel Leg. Stahl Hardness Härte 150~280HB	V(m/min)	100~150	100~150	100~150	100~150	
	Fz(mm/z)	0.1~0.4	0.1~0.4	0.1~0.4	0.1~0.4	
	a _p (mm)	6	6	12.5	25	
	a _e (mm)	--	5	6.5	3	
Die steel Gesenkstahl Hardness Härte 150~255HB	V(m/min)	80~120	80~120	80~120	80~120	
	Fz(mm/z)	0.1~0.3	0.1~0.3	0.1~0.3	0.1~0.3	
	a _p (mm)	6	6	12.5	25	
	a _e (mm)	--	5	6.5	3	
Hardened steel gehärteter Stahl Hardness Härte 40~50HRC	V(m/min)	80~100	80~100	80~100	--	
	Fz(mm/z)	0.08~0.15	0.08~0.15	0.08~0.15	--	
	a _p (mm)	6	6	12.5	--	
	a _e (mm)	--	5	6.5	--	
Grey Cast iron Grauguss Hardness Härte 160~260HB	V(m/min)	250~300	250~300	250~300	250~300	
	Fz(mm/z)	0.08~0.15	0.08~0.15	0.08~0.15	0.08~0.15	
	a _p (mm)	6	6	12.5	25	
	a _e (mm)	--	5	6.5	3	
Nodular Cast iron Kugelgrafitguss Hardness Härte 170~300HB	V(m/min)	200~250	200~250	200~250	200~250	
	Fz(mm/z)	0.08~0.15	0.08~0.15	0.08~0.15	0.08~0.15	
	a _p (mm)	6	6	12.5	25	
	a _e (mm)	--	5	6.5	3	

Milling · Fräsen

Indexable Milling Tools · Wendeplattenfräser

Diameter range
Durchmesser Bereich Ø30 Ø32

Recommended Cutting data · Schnittdaten

Operations Anwendung						
Workpiece material Werkstückstoff	Cutting data Schnittdaten	Machining of slot Nutenfräsen	Side milling (slight) Schulterfräsen		Side milling (deep) Schulterfräsen	Grade Sorte
Medium carbon steel Kohlenstoffstahl Hardness Härte 150~250HB	V(m/min)	150~220	150~220	150~220	150~220	YBG302
	Fz(mm/z)	0.1~0.4	0.1~0.4	0.1~0.4	0.1~0.4	
	a _p (mm)	10	10	16	28	
	a _e (mm)	--	6	9	6	
Alloy steel Leg. Stahl Hardness Härte 150~280HB	V(m/min)	100~150	100~150	100~150	100~150	
	Fz(mm/z)	0.1~0.4	0.1~0.4	0.1~0.4	0.1~0.4	
	a _p (mm)	10	10	16	28	
	a _e (mm)	--	6	9	6	
Die steel Gesenkstahl Hardness Härte 150~255HB	V(m/min)	80~120	80~120	80~120	80~120	
	Fz(mm/z)	0.1~0.3	0.1~0.3	0.1~0.3	0.1~0.3	
	a _p (mm)	10	10	16	28	
	a _e (mm)	--	6	9	6	
Hardened steel gehärteter Stahl Hardness Härte 40~50HRC	V(m/min)	80~100	80~100	80~100	--	
	Fz(mm/z)	0.08~0.15	0.08~0.15	0.08~0.15	--	
	a _p (mm)	10	10	16	--	
	a _e (mm)	--	6	9	--	
Grey Cast iron Grauguss Hardness Härte 160~260HB	V(m/min)	250~300	250~300	250~300	250~300	
	Fz(mm/z)	0.08~0.15	0.08~0.15	0.08~0.15	0.08~0.15	
	a _p (mm)	10	10	16	28	
	a _e (mm)	--	6	9	6	
Nodular Cast iron Kugelgrafitguss Hardness Härte 170~300HB	V(m/min)	200~250	200~250	200~250	200~250	
	Fz(mm/z)	0.08~0.15	0.08~0.15	0.08~0.15	0.08~0.15	
	a _p (mm)	10	10	16	28	
	a _e (mm)	--	6	9	6	

B
Milling Tools
Fräser

Diameter range

Durchmesser Bereich Ø40

Recommended Cutting data · Schnittdaten

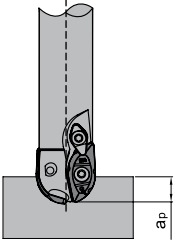
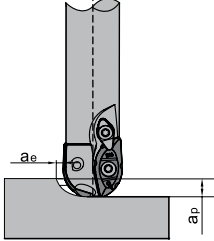
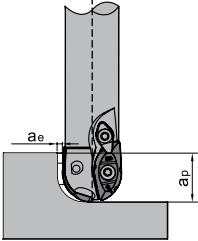
Operations Anwendung						
Workpiece material Werkstückstoff	Cutting data Schnittdaten	Machining of slot Nutenfräsen	Side milling (slight) Schulterfräsen		Side milling (deep) Schulterfräsen	Grade Sorte
Medium carbon steel Kohlenstoffstahl Hardness Härte 150~250HB	V(m/min)	150~220	150~220	150~220	150~220	YBG302
	Fz(mm/z)	0.1~0.4	0.1~0.4	0.1~0.4	0.1~0.4	
	a _p (mm)	12	10	20	35	
	a _e (mm)	--	8	12	8	
Alloy steel leg. Stahl Hardness Härte 150~280HB	V(m/min)	100~150	100~150	100~150	100~150	
	Fz(mm/z)	0.1~0.4	0.1~0.4	0.1~0.4	0.1~0.4	
	a _p (mm)	12	10	20	35	
	a _e (mm)	--	8	12	8	
Die steel Gesenkstahl Hardness Härte 150~255HB	V(m/min)	80~120	80~120	80~120	80~120	
	Fz(mm/z)	0.1~0.3	0.1~0.3	0.1~0.3	0.1~0.3	
	a _p (mm)	12	10	20	35	
	a _e (mm)	--	8	12	8	
Hardened steel gehärteter Stahl Hardness Härte 40~50HRC	V(m/min)	80~100	80~100	80~100	--	
	Fz(mm/z)	0.08~0.15	0.08~0.15	0.08~0.15	--	
	a _p (mm)	12	10	20	--	
	a _e (mm)	--	8	12	--	
Grey Cast iron Grauguss Hardness Härte 160~260HB	V(m/min)	250~300	250~300	250~300	250~300	
	Fz(mm/z)	0.08~0.15	0.08~0.15	0.08~0.15	0.08~0.15	
	a _p (mm)	12	10	20	35	
	a _e (mm)	--	8	12	8	
Nodular Cast iron Kugelgrafitguss Hardness Härte 170~300HB	V(m/min)	200~250	200~250	200~250	200~250	
	Fz(mm/z)	0.08~0.15	0.08~0.15	0.08~0.15	0.08~0.15	
	a _p (mm)	12	10	20	35	
	a _e (mm)	--	8	12	8	

Milling · Fräsen

Indexable Milling Tools · Wendeplattenfräser

Diameter range
Durchmesser Bereich Ø50

Recommended Cutting data · Schnittdaten

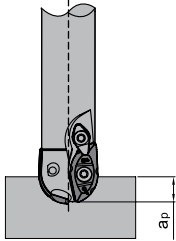
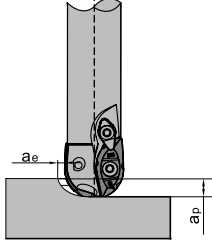
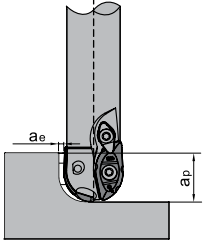
Operations Anwendung						Grade Sorte
Workpiece material Werkstückstoff	Cutting data Schnittdaten	Machining of slot Nutenfräsen	Side milling (slight) Schulterfräsen		Side milling (deep) Schulterfräsen	
Medium carbon steel Kohlenstoffstahl Hardness Härte 150~250HB	V(m/min)	150~220	150~220	150~220	150~220	YBG302
	Fz(mm/z)	0.1~0.4	0.1~0.4	0.1~0.4	0.1~0.4	
	a _p (mm)	15	10	25	40	
	a _e (mm)	--	10	15	10	
Alloy steel leg. Stahl Hardness Härte 150~280HB	V(m/min)	100~150	100~150	100~150	100~150	
	Fz(mm/z)	0.1~0.4	0.1~0.4	0.1~0.4	0.1~0.4	
	a _p (mm)	15	10	25	40	
	a _e (mm)	--	10	15	10	
Die steel Gesenkstahl Hardness Härte 150~255HB	V(m/min)	80~120	80~120	80~120	80~120	
	Fz(mm/z)	0.1~0.3	0.1~0.3	0.1~0.3	0.1~0.3	
	a _p (mm)	15	10	25	40	
	a _e (mm)	--	10	15	10	
Hardened steel gehärteter Stahl Hardness Härte 40~50HRC	V(m/min)	80~100	80~100	80~100	--	
	Fz(mm/z)	0.08~0.15	0.08~0.15	0.08~0.15	--	
	a _p (mm)	15	10	25	--	
	a _e (mm)	--	10	15	--	
Grey Cast iron Grauguss Hardness Härte 160~260HB	V(m/min)	250~300	250~300	250~300	250~300	
	Fz(mm/z)	0.08~0.15	0.08~0.15	0.08~0.15	0.08~0.15	
	a _p (mm)	15	10	25	40	
	a _e (mm)	--	10	15	10	
Nodular Cast iron Kugelgraphitguss Hardness Härte 170~300HB	V(m/min)	200~250	200~250	200~250	200~250	
	Fz(mm/z)	0.08~0.15	0.08~0.15	0.08~0.15	0.08~0.15	
	a _p (mm)	15	10	25	40	
	a _e (mm)	--	10	15	10	

B

Milling Tools
Fräser



Profile milling tools · Profilfräser

BMR04 P M K



Straight shank
Zylinderschaft

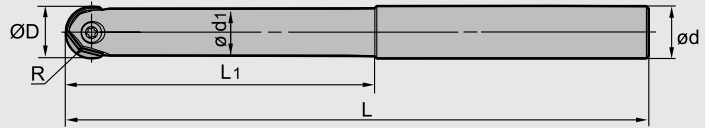

Specification of tools · Werkzeug Beschreibung

	Type Typ	Stock Lager	Dimensions (mm) Abmessungen						Weight Gewicht (kg)
			R	Ø D	ø d	ø d ₁	L ₁	L	
BMR04	-012-G12-M	●	6	12	12	11	35	125	0.1
	-012-G12-L	●	6	12	12	11	45	150	0.1
	-016-G16-M	●	8	16	16	14	40	150	0.2
	-016-G16-L	●	8	16	16	14	55	180	0.3
	-020-G20-M	●	10	20	20	18	65	180	0.4
	-020-G20-L	●	10	20	20	18	100	250	0.6
	-025-G25-M	●	12.5	25	25	23	70	200	0.7
	-025-G25-L	●	12.5	25	25	23	100	250	0.9
	-030-G32-M	●	15	30	32	27	80	250	1.2
	-030-G32-L	●	15	30	32	27	110	300	1.5
	-032-G32-M	●	16	32	32	29	80	250	1.4
	-032-G32-L	●	16	32	32	29	110	300	1.7

● Ex Stock / ab Lager ○ On demand / auf Anfrage

Applicable tool
Werkzeug **B11-B18**

Tools code key
Werkzeug ISO **B26-B27**

Grade selection guide
Sortenauswahl **B19-B23**

Technical data
Technische Daten **B236-B241**

Profile milling tools · Profilfräser



BMR04 **P** **M** **K**



Straight shank
Zylinderschaft

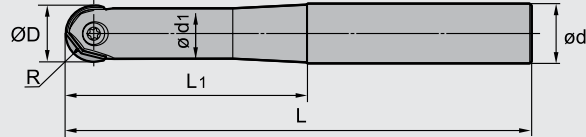





■ Specification of tools · Werkzeug Beschreibung

	Type Typ	Stock Lager	Dimensions (mm) Abmessungen						Weight Gewicht (kg)
			R	Ø D	ø d	ø d ₁	L ₁	L	
BMR04	-012-G16-M	●	6	12	16	11	50	125	0.2
	-012-G16-L	●	6	12	16	11	70	150	0.2
	-016-G20-M	●	8	16	20	14	60	150	0.3
	-016-G20-L	●	8	16	20	14	80	180	0.3
	-020-G25-M	●	10	20	25	18	75	180	0.6
	-020-G25-L	●	10	20	25	18	95	200	0.6
	-025-G32-M	●	12.5	25	32	23	90	200	1.0
	-025-G32-L	●	12.5	25	32	23	110	250	1.3
	-030-G40-M	●	15	30	40	27	110	250	2.0
	-030-G40-L	●	15	30	40	27	125	300	2.4
	-032-G40-M	●	16	32	40	29	110	250	2.0
	-032-G40-L	●	16	32	40	29	125	300	2.4

● Ex Stock / ab Lager ○ On demand / auf Anfrage

Spare parts · Ersatzteile

Diameter Durchmesser Ø D	Screw Schraube	Wrench Schlüssel	
			
Ø12	I70M4×10TT	WT15P	--
Ø16	I90M5×11TT	WT20P	--
Ø20	I90M5×13.5TT	WT20P	--
Ø25	I70M6×20TT	WT20P	--
Ø30	I70M8×25TT	--	WT30IT
Ø32	I70M8×25TT	--	WT30IT



Applicable inserts · Wendschneidplatten

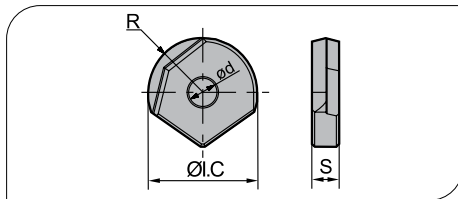

Workpiece Material Werkstoffe	Ideal Machining Condition Gute Bearbeitungsbedingungen			Normal Machining Condition Normale Bearbeitungsbedingungen			Unfavorable Machining Condition Ungünstige Bearbeitungsbedingungen		
	P	M	K	N	S				
P Steel Stahl	●	●	●	●	●	●	●	●	●
M Stainless Steel Rostfreier Stahl	●	●	●	●	●	●	●	●	●
K Cast iron Gusseisen	●	●	●	●	●	●	●	●	●
N Non-ferrous material Nichte Metalle	●	●	●	●	●	●	●	●	●
S Heat-resistant steel Warmfester Stahl	●	●	●	●	●	●	●	●	●

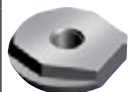
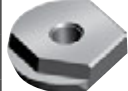
Insert WSP	Type Typ	Dimensions (mm) Abmessungen					CVD Coating CVD Beschicht.								PVD Coating PVD Beschicht.		Cermet Cemet	Carbide uncoat. unbe. Hartmetall									
		R	I.C	S	d	Applicable tools Zugehörige Werkzeug	YBC302	YBC301	YBC401	YBM253	YBM251	YBM351	YBD152	YBD252	YBG102	YBG205		YBG202	YBG212	YBG302	YBG152	YBG252	YNG151	YNG151C	YC30S	YD101	YD201
	ZOHX1203-GF	6	12	3	4	Φ12																					
	ZOHX1604-GF	8	16	4	5	Φ16																					
	ZOHX2005-GF	10	20	5	5	Φ20																					
	ZOHX2506-GF	12.5	25	6	6	Φ25																					
	ZOHX3007-GF	15	30	7	8	Φ30																					
	ZOHX3207-GF	16	32	7	8	Φ32																					
	ZOHX1203-GM	6	12	3	4	Φ12																					
	ZOHX1604-GM	8	16	4	5	Φ16																					
	ZOHX2005-GM	10	20	5	5	Φ20																					
	ZOHX2506-GM	12.5	25	6	6	Φ25																					
	ZOHX3007-GM	15	30	7	8	Φ30																					
	ZOHX3207-GM	16	32	7	8	Φ32																					

Applicable tool
Werkzeug **B11-B18**

Tools code key
Werkzeug ISO **B26-B27**

Grade selection guide
Sortenauswahl **B19-B23**

Technical data
Technische Daten **B236-B241**

BMR04

-GF

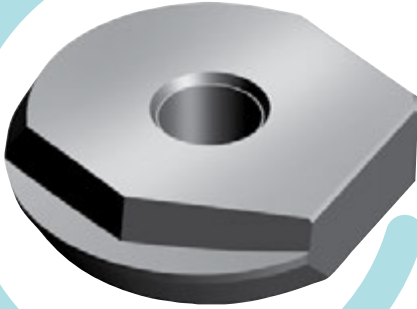

Positive rake angle and double clearance angle, the design of curved cutting edge take both sharpness and strength into consideration. The edge with high precision is applicable in the stable machining condition and the condition with high precision demand for workpiece profile.

Das spezielle Design aus positivem Spanwinkel und doppeltem Freiwinkel ermöglicht sowohl eine scharfe wie auch stabile Schneidkantenausführung. Die GF-Geometrie eignet sich besonders für Hochpräzisions- und Schlichtbearbeitung unter stabilen Maschinenbedingungen.

-GM

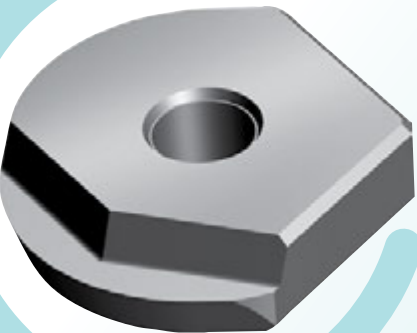

0° rake angle, only one clearance angle, high edge strength. Suitable for the machining condition requiring high cutting efficiency.

0° Grad Spanwinkel mit definiertem Freiwinkel ergeben eine sehr stabile Schneidkante. Für mittlere Bearbeitung mit hoher Effizienz.

The grade YBG 252 is a perfect combination of ultra fine grain carbide substrate and nano PVD-Coating.

Die Sorte YBG 252 ist die ideale Kombination von Ultra-Feinkorn-Hartmetallsubstrat und einer Nano-PVD-Beschichtung.

Calculation of cutting data for ball nose endmills (BMR02/04 series) Kalkulation der Schnittdaten für Kugelkopffräser (BMR02/04)

1. when tool axial line is vertical to the machined surface
Axiale Werkzeugachse zur vertikalen Fräsfläche:

$$N = \frac{1000 Vc}{\pi Dc} (r/min)$$

$$Dc = 2\sqrt{a_p(D - a_p)}$$

- N: revolution/min
Umdrehung/min
Vc: real cutting speed
effektive Schnittgeschwindigkeit
Dc: effective cutting diameter
effektive Ø
D: tool nominal diameter
nominale Ø
a_p: axial cutting depth
axiale Schnitttiefe

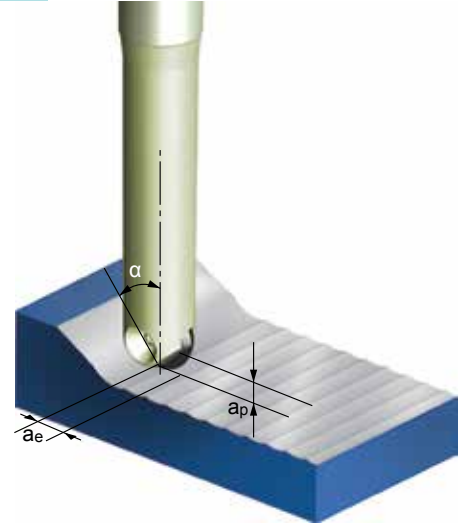

2. When there is a inclined angle between the tool axial line and the machined surface, the recommended cutting speed should be multiplied by a factor in the follow table to obtain the cutting speed used for programming

Unter Berücksichtigung des Neigungswinkels, (Werkzeugachse / bearbeitenden Oberfläche) erhalten Sie die empfohlene Schnittgeschwindigkeit durch in der Tabelle angegeben Multiplikator.

Diameter (mm) Durchmesser (mm) Ø		Ø12		Ø16		Ø20		Ø25		Ø30		Ø32	
depth of cut Schnitttiefe a _p (mm)		0.2	0.5	0.2	0.5	0.5	1	0.5	1	0.5	1.5	0.5	1.5
Inclined angle Neigungs- winkel α	15°	1.00	1.00	1.00	1.00	1.00	1.02	1.00	1.01	1.00	1.00	1.00	1.00
	30°	1.04	1.01	1.05	1.01	1.02	1.04	1.03	1.04	1.04	1.01	1.04	1.00
	45°	1.16	1.07	1.18	1.10	1.12	1.06	1.14	1.08	1.16	1.06	1.16	1.06
	60°	1.42	1.24	1.47	1.30	1.34	1.21	1.38	1.25	1.42	1.21	1.43	1.22
	75°	2.02	1.60	2.14	1.73	1.83	1.53	1.93	1.62	2.01	1.53	2.04	1.55
	90°	3.92	2.50	4.48	2.87	3.20	2.29	3.57	2.55	3.9	2.29	4.03	2.37

Milling · Fräsen

Indexable Milling Tools · Wendeplattenfräser

Recommended Cutting data · Schnittdaten

Workpiece material Werkstückstoff	Hardness Härte HB	Grade Sorte	Cutting data Schnittdaten	Diameter Durchmesser Ø D						
				Ø12	Ø16	Ø20	Ø25	Ø30	Ø32	
P	carbon steel leg. Kohlenstoff- stahl	HB≤180	V(m/min)	100~200	100~200	100~200	100~200	100~200	100~200	
			fz(mm/z)	0.15~0.25	0.2~0.3	0.2~0.3	0.25~0.35	0.25~0.35	0.25~0.35	
			apmax(mm)	0.8	1	1.25	1.5	2	2	
			aemax(mm)	0.8	1	1.25	1.5	2	2	
	Alloy steel Leg. Stahl	HB180~280	V(m/min)	80~180	80~180	80~180	80~180	80~180	80~180	
			fz(mm/z)	0.15~0.25	0.2~0.3	0.2~0.3	0.25~0.35	0.25~0.35	0.25~0.35	
			apmax(mm)	0.8	1	1.25	1.5	2	2	
			aemax(mm)	0.8	1	1.25	1.5	2	2	
	Hardened steel gehärteter Stahl	HRC55~65	YBG252	V(m/min)	60~100	60~100	60~100	60~100	60~100	60~100
				fz(mm/z)	0.15~0.25	0.2~0.3	0.2~0.3	0.25~0.35	0.25~0.35	0.25~0.35
				apmax(mm)	0.4	0.5	0.6	0.8	1	1
				aemax(mm)	0.4	0.5	0.6	0.8	1	1
M	Stainless steel Rostfreier Stahl	HB≤270	V(m/min)	70~150	70~150	70~150	70~150	70~150	70~150	
			fz(mm/z)	0.1~0.2	0.1~0.25	0.1~0.25	0.2~0.3	0.2~0.3	0.2~0.3	
			apmax(mm)	0.6	0.8	1	1.25	1.5	1.5	
			aemax(mm)	0.6	0.8	1	1.25	1.5	1.5	
K	Cast iron Gusseisen	HB180-250	V(m/min)	160~300	160~300	160~300	160~300	160~300	160~300	
			fz(mm/z)	0.2~0.3	0.25~0.35	0.25~0.35	0.3~0.4	0.3~0.4	0.3~0.4	
			apmax(mm)	1	1.5	1.8	2	2.5	2.5	
			aemax(mm)	1	1.5	1.8	2	2.5	2.5	

B

Milling Tools
Fräser

Case study for BMR04 Bearbeitungsbeispiel für BMR04



- Tool / Werkzeug: BMR04-020-G25-M
- Insert / WSP: ZOHX2005-GM/YBG252

Workpiece material: 42CrMo (HRC35)
Werkstoff:

Cooling system: dry cutting
Kühlsystem: trocken

Machine: vertical machining center
Maschine: vertikales Maschinen-Center

Cutting data
Schnittdaten:

$V_c=150\text{m/min}$

$a_p=0.1\text{mm}$

$f_z=0.2\text{mm/Z}$

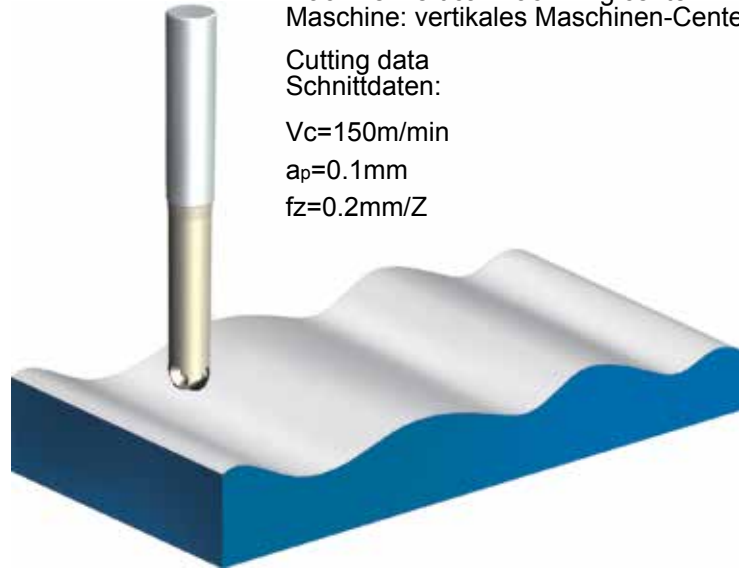

● Abrasion comparison of inserts after milling curved face Vergleich des Freiflächenverschleiß nach dem Fräsen einer Freiformfläche

ZCC-CT

Competitor A
Wettbewerber A

60 minutes later
Nach 60 Minuten



Flank abrasion 0.08
Freiflächenverschleiß 0.08

Flank abrasion 0.10
Freiflächenverschleiß 0.10

120 minutes later
Nach 120 Minuten



Flank abrasion 0.12
Freiflächenverschleiß 0.12

Flank abrasion 0.16
Freiflächenverschleiß 0.16

Milling · Fräsen

Indexable Milling Tools · Wendeplattenfräser

Side and face milling tools · Scheiben- und Planfräser code key

Milling tool type Fräserotyp	
FM	Face milling Planfräsen
EM	Square shoulder milling Eckfräsen
HM	Helical end milling Spiralfräsen
SM	Side and face milling Eck- und Planfräsen
BM	Profile milling Profilfräsen
CM	Chamfer milling Fasfräsen
XM	Special milling Spezialfräsen

Approach angle Anstellwinkel		
P	90°	
E	75°	
D	60°	
A	45°	
R		

Sequence number of series
Serien Nummer

Cutting diameter ØD (mm)
Fräserdurchmesser

Cutting width of milling tools
Schnittbreite

Coupling structure and demension Aufnahmetyp			
A	A type / A Typ	D	D type / D Typ
B	B type / B Typ	K	Mounting by keyway Mit Passfeder
C	C type / C Typ		

SM P 03 - 160 × 16 - K40

- M P 12 - 12 L

Insert WSP	
C	Diamond with 80° Raute mit 80°
D	Diamond with 55° Raute mit 55°
R	Round Rund
S	Square Viereckig
T	Regular triangle dreieckig
V	Diamond with 35° Raute mit 35°
M	Diamond with 86° Raute mit 86°

Insert clearance angle Freiwinkel	
N	0°
B	5°
C	7°
P	11°
D	15°
E	20°

Diameter of IC Durchmesser Innenkreis	Length of cutting edge Schneidkantenlänge					
	Insert · WSP					
	C	D	R	S	T	V
5.556	—	—	—	—	09	—
6.350	06	07	—	—	11	—
9.525	09	11	09	09	16	16
12.700	12	15	12	12	22	22
15.875	16	19	15	15	27	—
19.050	19	—	19	19	33	—
25.400	25	—	25	25	44	—

Cutting direction
Schnitttrichtung
(R: right L: left)
(R: rechts L: links)

Number of teeth
Zähnezahl

Milling Tools
Fräser

Side and face milling tools · Scheibenfräser

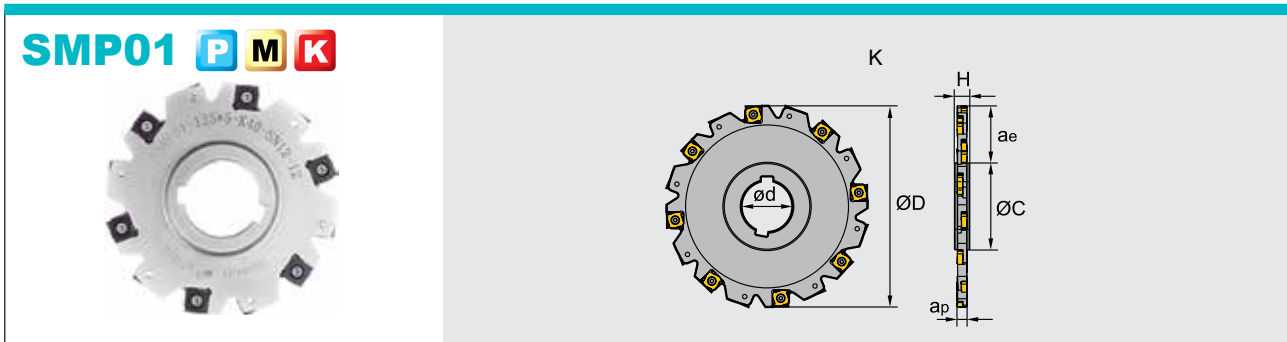

Specification of tools · Werkzeug Beschreibung

Type Typ	Stock Lager	Dimensions (mm) Abmessungen						Inserts WSP	No. of teeth Zähne	Coupling Aufnahme	Weight Gewicht (kg)	
		Ø D	ø d	ø c	H	ap	ae max					
Mounting by keyway	●	-100×4-K27-SN12-10	100	27	45	12	4	25	XSEQ1202	10	K	0.2
	●	-125×4-K40-SN12-12	125	40	56	12	4	32		12	K	0.3
	●	-160×4-K40-SN12-16	160	40	67	12	4	44		16	K	0.5
Mit Passfeder	●	-100×5-K27-SN12-10	100	27	45	12	5	25	XSEQ1203	10	K	0.2
	○	-125×5-K40-SN12-12	125	40	56	12	5	32		12	K	0.3
	○	-160×5-K40-SN12-16	160	40	67	12	5	44		16	K	0.6
	●	-100×6-K27-SN12-10	100	27	45	12	6	25	XSEQ12T3	10	K	0.3
	●	-125×6-K40-SN12-12	125	40	56	12	6	32		12	K	0.4
	●	-160×6-K40-SN12-16	160	40	67	12	6	44		16	K	0.7
	○	-200×6-K50-SN12-18	200	50	71	12	6	62	XSEQ12T4	18	K	1.1
	●	-250×6-K50-SN12-24	250	50	71	12	6	87		24	K	1.7
	●	-100×7-K27-SN12-10	100	27	45	12	7	25		XSEQ1204	10	K
	●	-125×7-K40-SN12-12	125	40	56	12	7	32	12		K	0.4
	●	-160×7-K40-SN12-16	160	40	67	12	7	44	16		K	0.8
	●	-200×7-K50-SN12-18	200	50	71	12	7	62	XSEQ12T4	18	K	1.2
	○	-250×7-K50-SN12-24	250	50	71	12	7	87		24	K	1.9
	●	-100×8-K27-SN12-10	100	27	45	12	8	25		XSEQ12T4	10	K
	●	-125×8-K40-SN12-12	125	40	56	12	8	32	12		K	0.5
●	-160×8-K40-SN12-16	160	40	67	12	8	44	16	K		0.9	
●	-200×8-K50-SN12-18	200	50	71	12	8	62	18	K		1.4	
●	-250×8-K50-SN12-24	250	50	71	12	8	87	24	K		2.2	

● Ex Stock / ab Lager ○ On demand / auf Anfrage

Applicable tool
Werkzeug

[B11-B18](#)

Tools code key
Werkzeug ISO

[B26-B27](#)

Grade selection guide
Sortenauswahl

[B19-B23](#)

Technical data
Technische Daten

[B236-B241](#)

Side and face milling tools · Scheibenfräser



SMP01 **P** **M** **K**

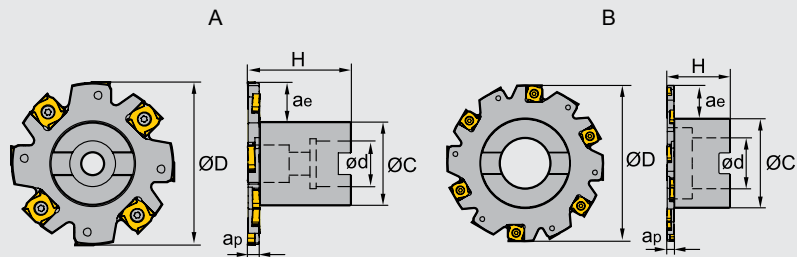



Specification of tools · Werkzeug Beschreibung

Type Typ	Stock Lager		Dimensions (mm) Abmessungen							Inserts WSP	No. of teeth Zähne	Coupling Aufnahme	Weight Gewicht (kg)
	R	L	Ø D	ø d	ø c	H	ap	ae _{max}					
SMP01 Arbor mounting	-063×4-A22-SN12-06	●	○	63	22	32	40	4	14	XSEQ1202	6	A	0.2
	-080×4-A22-SN12-08	●	○	80	22	40	40	4	18		8	A	0.4
	-100×4-A27-SN12-10	●	○	100	27	48	50	4	23		10	A	0.6
Arbor Aufnahme	-063×5-A22-SN12-06	○	○	63	22	32	40	5	14	XSEQ1203	6	A	0.2
	-080×5-A22-SN12-08	●	○	80	22	40	40	5	18		8	A	0.4
	-100×5-A27-SN12-10	●	○	100	27	48	50	5	23		10	A	0.7
	-063×6-A22-SN12-06	●	○	63	22	32	40	6	14	XSEQ12T3	6	A	0.2
	-080×6-A22-SN12-08	●	○	80	22	40	40	6	18		8	A	0.5
	-100×6-A27-SN12-10	●	○	100	27	48	50	6	23		10	A	0.7
	-125×6-B40-SN12-12	●	○	125	40	70	50	6	30		12	B	1.0
	-160×6-B40-SN12-16	●	○	160	40	70	60	6	41		16	B	1.3
	-063×7-A22-SN12-06	○	○	63	22	32	40	7	14		XSEQ1204	6	A
-080×7-A22-SN12-08	○	○	80	22	40	40	7	18	8	A		0.5	
-100×7-A27-SN12-10	○	○	100	27	48	50	7	23	10	A		0.7	
	-125×7-B40-SN12-12	○	○	125	40	70	50	7	30		12	B	1.1
	-160×7-B40-SN12-16	○	○	160	40	70	60	7	41		16	B	1.4
	-063×8-A22-SN12-06	●	○	63	22	32	40	8	14		XSEQ12T4	6	A
-080×8-A22-SN12-08	○	○	80	22	40	40	8	18	8	A		0.5	
-100×8-A27-SN12-10	●	○	100	27	48	50	8	23	10	A		0.8	
	-125×8-B40-SN12-12	○	○	125	40	70	50	8	30		12	B	1.1
	-160×8-B40-SN12-16	●	○	160	40	70	60	8	41		16	B	1.5

● Ex Stock / ab Lager ○ On demand / auf Anfrage

Spare parts - Ersatzteile

Diameter Durchmesser Ø D	Cutting width Schnittbreite a _p	Screw Schraube	Wrench Schlüssel	
				
Ø63-Ø160	4	I91M4×3.2X	WT08IP	
Ø63-Ø160	5	I91M4×4.2X		
Ø63-Ø250	6	I91M4×5.1X		
Ø63-Ø250	7	I91M4×6.1X		
Ø63-Ø250	8	I91M4×7.1X		

Applicable inserts - Wendschneidplatten

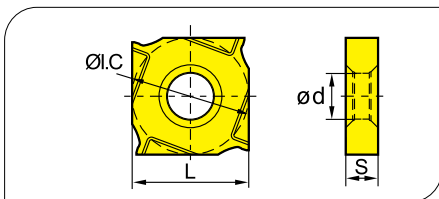

Workpiece Material Werkstoffe	Ideal Machining Condition Gute Bearbeitungsbedingungen			Normal Machining Condition Normale Bearbeitungsbedingungen			Unfavorable Machining Condition Ungünstige Bearbeitungsbedingungen		
	P	M	K	P	M	K	P	M	K
P Steel Stahl	●	●	●	●	●	●	●	●	●
M Stainless Steel Rostfreier Stahl	●	●	●	●	●	●	●	●	●
K Cast iron Gusseisen	●	●	●	●	●	●	●	●	●
N Non-ferrite material Ne Metalle	●	●	●	●	●	●	●	●	●
S Heat-resistant steel Warmfester Stahl	●	●	●	●	●	●	●	●	●

Insert WSP	Type Typ	Dimensions (mm) Abmessungen				CVD Coating CVD Beschicht.				PVD Coating PVD Beschicht.				Cermet Cermet	Carbide uncoat. unbe. Hartmetall													
		I.C	L	S	d	YBC302	YBC301	YBC401	YBM253	YBM251	YBM351	YBD152	YBD252		YBG102	YB9320	YBG205	YBG202	YBG212	YBG302	YBG152	YBG252	YNG151	YNG151C	YC30S	YD101	YD201	
	XSEQ1202	12.7	12.7	2.3	5.0																							
	XSEQ1203	12.7	12.7	3.0	5.0	●			●									●										
	XSEQ12T3	12.7	12.7	3.5	5.0		●												●								○	
	XSEQ1204	12.7	12.7	4.0	5.0															●								
	XSEQ12T4	12.7	12.7	4.5	5.0																●							

Recommended Cutting data - Schnittdaten

	Workpiece material Werkstückstoff	Hardness HB Härte	Grade Sorte	Cutting data Schnittdaten	
				V(m/min)	f(mm/z)
P	Low-carbon steel Soft steel Niedriglegierter Kohlenstoffstahl Baustahl	≤180	YBG202	180 (100-250)	0.1(0.08-0.25)
			YBG302	150 (100-200)	0.15(0.1-0.3)
	High-carbon steel Alloy steel Hochleg. Kohlenstoffstahl Leg. Stahl	180-280	YBG202	150 (80-250)	0.1(0.08-0.25)
			YBG302	120 (80-200)	0.15(0.1-0.3)
M	Stainless steel Rostfreier Stahl	≤270	YBG202	120 (80-250)	0.1(0.05-0.15)
			YBG302	100 (80-200)	0.08(0.05-0.15)
K	Cast iron Gusseisen	180-250	YBG152	120 (80-250)	0.1(0.05-0.15)
			YBG302	150 (100-250)	0.08(0.05-0.15)

Applicable tool
Werkzeug **B11-B18**

Tools code key
Werkzeug ISO **B26-B27**

Grade selection guide
Sortenauswahl **B19-B23**

Technical data
Technische Daten **B236-B241**

Milling · Fräsen

Indexable Milling Tools · Wendepplattenfräser

Side and face milling tools · Scheibenfräser



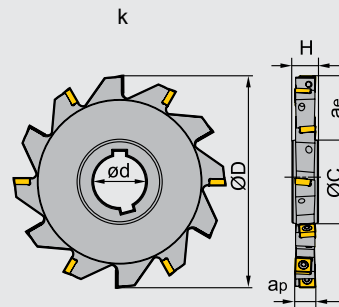

SMP03 **P** **M** **K**



■ Specification of tools · Werkzeug Beschreibung

Type Typ	Stock Lager	Dimensions (mm) Abmessungen							Inserts WSP	No. of teeth Zähne	Coupling Aufnahme	Weight Gewicht (kg)
		ØD	øc	ød	ae _{max}	ap	H					
SMP03 Arbor mounting	●	80	44.0	27	17.6	8	12	MPHT060304-DM	10	K	0.2	
	○	100	49.0	32	25.1	8	12		14	K	0.3	
Arbor Aufnahme	○	100	49.0	32	25.1	10	14		MPHT080305-DM	14	K	0.4
	○	125	57.0	40	33.6	10	14			16	K	0.6
	●	125	58.3	40	32.6	12	16		MPHT120408-DM	12	K	0.7
	●	160	64.3	40	31.5	12	16			14	K	1.3
	●	160	64.6	40	47.6	16	20			12	K	1.6
	○	160	65.3	40	47.3	18	24			12	K	1.9
	○	160	65.3	40	47.3	20	26			12	K	2.1
	○	200	74.6	50	62.6	16	20			14	K	2.5
	○	200	75.3	50	62.3	18	24			14	K	2.9
	○	200	75.3	50	62.3	20	26			14	K	3.3

■ Spare parts · Ersatzteile

Diameter Durchmesser Ø D	Insert WSP	Screw Schraube	Wrench Schlüssel	
				
Ø80-Ø125	MP06	I60M2.5x6.5	WT07IP	--
Ø125-Ø160	MP08	I60M3x7	WT09IP	--
Ø160-Ø200	MP12	I60M5x13	--	WT20IS



● Ex Stock / ab Lager ○ On demand / auf Anfrage

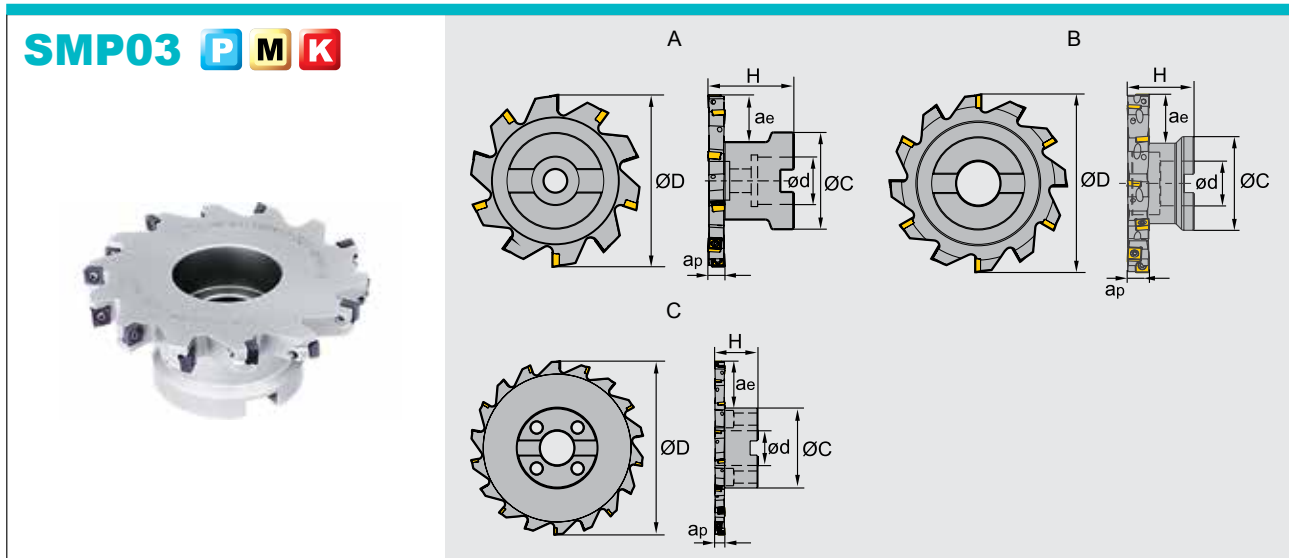

Side and face milling tools - Scheibenfräser



Specification of tools - Werkzeug Beschreibung

Type Typ	Stock Lager	Dimensions (mm) Abmessungen							Inserts WSP	No. of teeth Zähne	Coupling Aufnahme	Weight Gewicht (kg)		
		R	L	Ø D	ø c	ø d	a _{max}	a _p					H	
SMP03 Arbor mounting	-080×8-A22-MP06-10	●	○	80	45	22	21	8	40	MPHT060304-DM	10	A	0.4	
	-100×8-B27-MP06-14	●	○	100	55	27	24.5	8	40		14	B	0.6	
Arbor Aufnahme	-100×10-B27-MP06-14	●	○	100	55	27	24.5	10	40		MPHT080305-DM	14	B	0.7
	-125×10-B32-MP06-16	●	○	125	65	32	33.3	10	45			16	B	1.1
	-125×12-B32-MP08-12	○	○	125	65	32	33	12	45	MPHT120408-DM		12	B	1.4
	-160×12-B40-MP08-14	○	○	160	80	40	44	12	50			14	B	1.9
	-200×12-C40-MP08-18	○	○	200	92	40	52	12	50	MPHT120408-DM	18	C	3.2	
	-125×16-B32-MP12-10	●	○	125	65	32	33	16	50		10	B	2.3	
	-160×16-B40-MP12-12	○	○	160	80	40	45	16	60	MPHT120408-DM	12	B	2.3	
	-160×18-B40-MP12-12	●	○	160	80	40	45	18	60		12	B	2.4	
	-200×16-C40-MP12-14	○	○	200	92	40	52	16	50	MPHT120408-DM	14	C	3.6	
	-200×18-C40-MP12-14	○	○	200	92	40	52	18	50		14	C	3.9	
	-200×20-C40-MP12-14	○	○	200	92	40	52	20	50	14	C	4.2		

Spare parts - Ersatzteile

Diameter Durchmesser Ø D	Insert WSP	Screw Schraube	Wrench Schlüssel	
				
Ø80-Ø125	MP06	I60M2.5×6.5	WT07IP	
Ø125-Ø200	MP08	I60M3×7	WT09P	
Ø125-Ø200	MP12	I60M5×13		WT20IS

Applicable tool
Werkzeug **B11-B18**

Tools code key
Werkzeug ISO **B26-B27**

Grade selection guide
Sortenauswahl **B19-B23**

Technical data
Technische Daten **B236-B241**

Milling · Fräsen

Indexable Milling · Fräswendeplatten

Applicable inserts · Wendschneidplatten

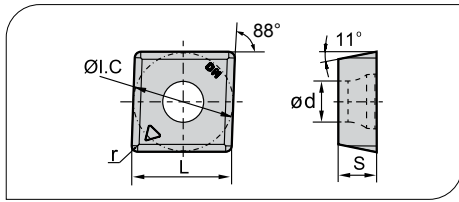

Workpiece Material Werkstoff	Ideal Machining Condition Gute Bearbeitungsbedingungen			Normal Machining Condition Normale Bearbeitungsbedingungen			Unfavorable Machining Condition Ungünstige Bearbeitungsbedingungen		
	Steel Stahl	Stainless Steel Rostfreier Stahl	Cast iron Gusseisen	Steel Stahl	Stainless Steel Rostfreier Stahl	Cast iron Gusseisen	Steel Stahl	Stainless Steel Rostfreier Stahl	Cast iron Gusseisen
P Steel Stahl	●	●	●	●	●	●	●	●	●
M Stainless Steel Rostfreier Stahl	●	●	●	●	●	●	●	●	●
K Cast iron Gusseisen	●	●	●	●	●	●	●	●	●
N Non-ferrous material Nichtmetalle	●	●	●	●	●	●	●	●	●
S Heat-resistant steel Wärmebeständiger Stahl	●	●	●	●	●	●	●	●	●

Insert WSP	Type Typ	Dimensions (mm) Abmessungen					CVD Coating CVD Beschicht.						PVD Coating PVD Beschicht.				Cermets Cermet	Carbide uncoat. unbe. Hartmetall										
		I.C.	L	S	d	r	YBC302	YBC301	YBC401	YBM253	YBM251	YBM351	YBD152	YBD252	YBG102	YBG320		YBG205	YBG202	YBG212	YBG302	YBG152	YBG252	YNG151	YNG151C	YC30S	YD101	YD201
	MPHT060304-DM	6.35	6.35	3.18	2.8	0.4	●			●										●								
	MPHT080305-DM	8.3	8.3	3.18	5.56	0.5	●			●										●								
	MPHT120408-DM	12.7	12.7	4.76	5.56	0.8	●			●		●								●								

Recommended Cutting data · Schnittdaten

	Workpiece material Werkstückstoff	Hardness HB Härte	Grade Sorte	Cutting data Schnittdaten	
				V(m/min)	f(mm/z)
P	Low-carbon steel Soft steel Niedriglegierter Kohlenstoffstahl Baustahl	≤180	YBM251 YBG202	180 (100-250)	0.1(0.08-0.25)
			YBG302	150 (100-200)	0.15(0.1-0.3)
	High-carbon steel Alloy steel Hochleg. Kohlenstoffstahl Leg. Stahl	180-280	YBM251 YBG202	150 (80-250)	0.1(0.08-0.25)
			YBG302	120 (80-200)	0.15(0.1-0.3)
	Alloy tool steel Leg. Werkzeugstahl	280-350	YBM251 YBG202	120 (80-250)	0.1(0.08-0.25)
			YBG302	100 (80-200)	0.15(0.1-0.3)
M	Stainless steel Rostfreier Stahl	≤270	YBM251 YBG202	120 (80-250)	0.1(0.05-0.15)
			YBG302	100 (80-200)	0.08(0.05-0.15)
K	Cast iron Gusseisen	180-250	YBG152	120 (80-250)	0.1(0.05-0.15)
			YBG302	150 (100-250)	0.08(0.05-0.15)

● Ex Stock / ab Lager ○ On demand / auf Anfrage

Groove milling tools · Nutenfräser

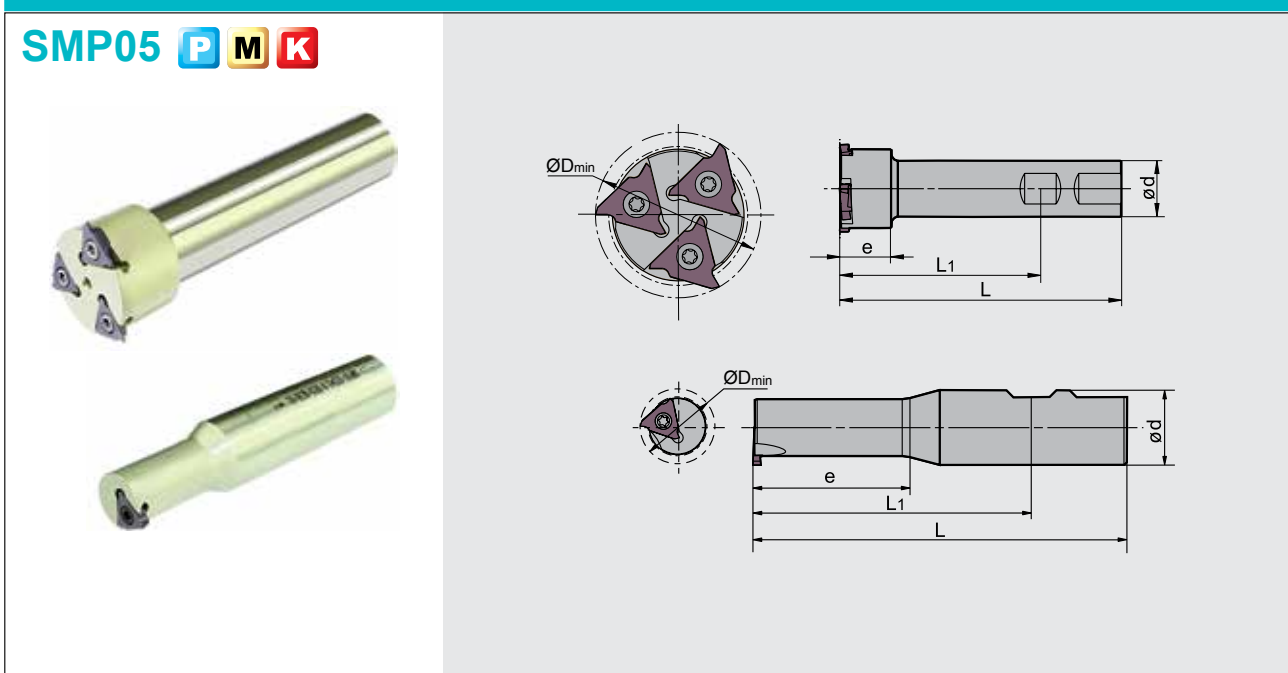

Specification of tools · Werkzeug Beschreibung

Type Typ	Stock Lager	Dimensions (mm) Abmessungen					No. of teeth Zähne	Inserts WSP	W(mm)
		ØD _{min}	ød	e	L ₁	L			
SMP05 -025×3.0-XP25-QC16-01	●	25	25	40	89	125	1	QC16L 110~300	1.10-3.00
-039×3.0-XP25-QC16-03	●	39	25	23	89	125	3	QC16L 110~300	1.10-3.00
-044×4.8-XP25-QC22-03	●	44	25	23	89	125	3	QC22L 125~480	1.25-4.8

Spare parts · Ersatzteile

Diameter Durchmesser Ø D	Screw Schraube	Wrench Schlüssel
Ø25	I60M3.5×10	WT15IP
Ø39	I60M3.5×10	WT15IP
Ø44	I60M5×13	WT20IP



Applicable tool
Werkzeug

[B11-B18](#)

Tools code key
Werkzeug ISO

[B26-B27](#)

Grade selection guide
Sortenauswahl

[B19-B23](#)

Technical data
Technische Daten

[B236-B241](#)

Milling · Fräsen

Indexable Milling · Fräswendeplatten

Applicable inserts · Wendschneidplatten

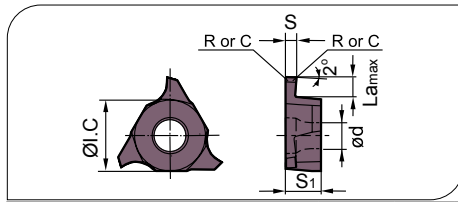

Workpiece Material Werkstoffe	Ideal Machining Condition Gute Bearbeitungsbedingungen			Normal Machining Condition Normale Bearbeitungsbedingungen			Unfavorable Machining Condition Ungünstige Bearbeitungsbedingungen		
	Steel Stahl	Stainless Steel Rostfreier Stahl	Cast iron Gusseisen	Steel Stahl	Stainless Steel Rostfreier Stahl	Cast iron Gusseisen	Steel Stahl	Stainless Steel Rostfreier Stahl	Cast iron Gusseisen
P Steel Stahl	●	●	●	●	●	●	●	●	●
M Stainless Steel Rostfreier Stahl	●	●	●	●	●	●	●	●	●
K Cast iron Gusseisen	●	●	●	●	●	●	●	●	●
N Non-ferrous material Nichtmetalle	●	●	●	●	●	●	●	●	●
S Heat-resistant steel Wärmebeständiger Stahl	●	●	●	●	●	●	●	●	●

Insert WSP	Type Typ	Dimensions (mm) Abmessungen						CVD Coating CVD Beschicht.						PVD Coating PVD Beschicht.						Cermet Cermet	Carbide uncoat. unbe. Hartmetall																
		S±0.025	La _{max}	R/C	ØI.C	S ₁	ød	YBC302	YBC301	YBC401	YBM253	YBM251	YBM351	YBD152	YBD252	YBG102	YB9320	YBG205	YBG202		YBG212	YBG302	YBG152	YBG252	YNG151	YNG151C	YC30S	YD101	YD201								
	QC16L110-R01	1.10	2.00	R0.1	9.525	3.18	4.4										●	●																			
	QC16L125-R02	1.25	2.00	R0.2	9.525	3.18	4.4											●																			
	QC16L145-R02	1.45	2.00	R0.2	9.525	3.18	4.4											●																			
	QC16L150-R02	1.50	2.00	R0.2	9.525	3.18	4.4												●																		
	QC16L175-R02	1.75	2.00	R0.2	9.525	3.18	4.4												●																		
	QC16L185-R02	1.85	2.50	R0.2	9.525	3.18	4.4												●																		
	QC16L200-R02	2.00	2.50	R0.2	9.525	3.18	4.4												●																		
	QC16L250-R02	2.50	2.50	R0.2	9.525	3.18	4.4												●																		
	QC16L300-R02	3.00	3.00	R0.2	9.525	3.18	4.4												●																		

● Ex Stock / ab Lager ○ On demand / auf Anfrage

Applicable inserts · Wendschneidplatten

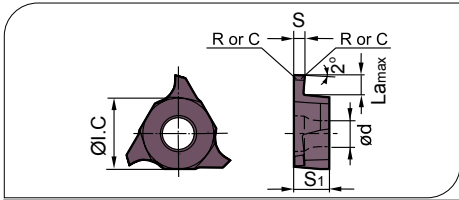

Workpiece Material Werkstoffe	Ideal Machining Condition Gute Bearbeitungsbedingungen			Normal Machining Condition Normale Bearbeitungsbedingungen			Unfavorable Machining Condition Ungünstige Bearbeitungsbedingungen		
	Steel Stahl	Stainless Steel Rostfreier Stahl	Cast iron Gusseisen	Steel Stahl	Stainless Steel Rostfreier Stahl	Cast iron Gusseisen	Steel Stahl	Stainless Steel Rostfreier Stahl	Cast iron Gusseisen
P Steel Stahl	●	●	●	●	●	●	●	●	●
M Stainless Steel Rostfreier Stahl	●	●	●	●	●	●	●	●	●
K Cast iron Gusseisen	●	●	●	●	●	●	●	●	●
N Non-ferrous material Nichtmetalle	●	●	●	●	●	●	●	●	●
S Heat-resistant steel Wärmebeständiger Stahl	●	●	●	●	●	●	●	●	●

Insert WSP	Type Typ	Dimensions (mm) Abmessungen						CVD Coating CVD Beschicht.						PVD Coating PVD Beschicht.				Cermets Cermet	Carbide uncoat. unbe. Hartmetall										
		S±0.025	L _{max}	R/C	ØI.C	S ₁	ød	YBC302	YBC301	YBC401	YBM255	YBM251	YBM351	YBD152	YBD252	YBG102	YB9320		YBG205	YBG202	YBG212	YBG302	YBG152	YBG252	YNG151	YNG151C	YC30S	YD101	YD201
	QC22L125-R02	1.25	2.00	R0.2	12.70	4.76	5.5										●	○											
	QC22L145-R02	1.45	2.00	R0.2	12.70	4.76	5.5										●	○											
	QC22L150-R02	1.50	3.50	R0.2	12.70	4.76	5.5										●												
	QC22L175-R02	1.75	3.50	R0.2	12.70	4.76	5.5										●	○											
	QC22L185-R02	1.85	3.50	R0.2	12.70	4.76	5.5										●	○											
	QC22L200-R02	2.00	3.50	R0.2	12.70	4.76	5.5										●												
	QC22L230-R02	2.30	3.50	R0.2	12.70	4.76	5.5										○												
	QC22L250-R03	2.50	4.00	R0.3	12.70	4.76	5.5										●												
	QC22L265-R03	2.65	4.00	R0.3	12.70	4.76	5.5										●												
	QC22L280-R03	2.80	4.00	R0.3	12.70	4.76	5.5										●												
	QC22L300-R03	3.00	4.00	R0.3	12.70	4.76	5.5										●												
	QC22L320-R03	3.20	4.00	R0.3	12.70	4.76	5.5										●												
	QC22L330-R03	3.30	4.00	R0.3	12.70	4.76	5.5										●	○											
	QC22L350-R03	3.50	5.00	R0.3	12.70	4.76	5.5										●												
	QC22L400-R04	4.00	5.00	R0.4	12.70	4.76	5.5										●												
	QC22L430-R04	4.30	5.00	R0.4	12.70	4.76	5.5										●	●											
	QC22L450-R04	4.50	5.00	R0.4	12.70	4.76	5.5										○	○											
	QC22L480-R04	4.80	5.00	R0.4	12.70	5.06	5.5										○	○											

B

Milling Tools
Fräser

Applicable tool
Werkzeug **B11-B18**

Tools code key
Werkzeug ISO **B26-B27**

Grade selection guide
Sortenauswahl **B19-B23**

Technical data
Technische Daten **B236-B241**

Milling · Fräsen

Indexable Milling Tools · Wendeplattenfräser



High feed milling cutters · Hochvorschubfräser

XMR01 P M K

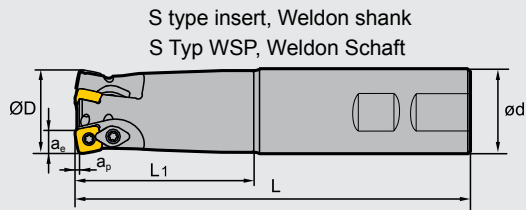

■ Specification of tools · Werkzeug-Beschreibung With internal cooling · Mit Innenkühlung

	Type Typ	✱	Stock Lager	Dimensions (mm) Abmessungen						No. of teeth Zähne	Weight Gewicht (kg)
				Ø D	ap	ae	L1	L	Ø d		
XMR01	-020-XP20-SD06-02	✱	●	20	0.8	5.8	50	130	20	2	0.26
	-025-XP25-SD06-03	✱	●	25	0.8	5.8	60	140	25	3	0.46
	-025-XP25-SD09-02	✱	●	25	1.4	8.8	60	140	25	2	0.5
	-032-XP32-SD09-03	✱	●	32	1.4	8.8	70	150	32	3	0.8
	-035-XP32-SD09-03	✱	●	35	1.4	8.8	70	150	32	3	0.8
	-032-XP32-SD12-02	✱	●	32	1.8	11.7	70	150	32	2	0.8
	-040-XP40-SD12-03	✱	●	40	1.8	11.7	70	150	40	3	1.3
	-040-XP40-SD15-02	✱	●	40	2.2	14	70	200	40	2	1.6

● Ex Stock / ab Lager ○ On demand / auf Anfrage ✱ With internal cooling · Mit Innenkühlung

XMR01 P M K

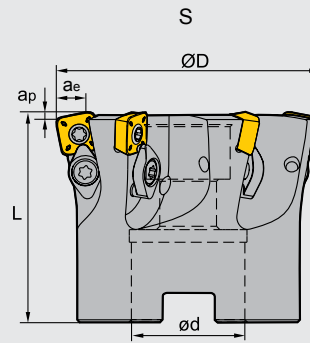

■ Specification of tools · Werkzeug-Beschreibung
With internal cooling · Mit Innenkühlung

Type Typ	* Stock Lager	Dimensions (mm) Abmessungen						No. of teeth Zähne	Coupling Aufnahme	Weight Gewicht (kg)
		Ø D	ap	ae	L	ø d				
XMR01 -050-A22-SD06-07	○	50	0.8	5.8	40	22	7	A	0.36	
-063-A22-SD06-10	●	63	0.8	5.8	40	22	10	A	0.53	
-063-A27-SD06-10	○	63	0.8	5.8	50	27	10	A	0.57	
-040-A16-SD09-04	○	40	1.4	8.8	40	16	4	A	0.182	
-050-A22-SD09-04	●	50	1.4	8.8	40	22	4	A	0.3	
-050-A22-SD09-04C	* ●	50	1.4	8.8	40	22	4	A	0.3	
-063-A22-SD09-06	●	63	1.4	8.8	40	22	6	A	0.5	
-063-A22-SD09-07	●	63	1.4	8.8	40	22	7	A	0.44	
-063-A22-SD09-06C	* ●	63	1.4	8.8	40	22	6	A	0.5	
-063-A27-SD09-06	○	63	1.4	8.8	50	27	6	A	0.6	
-063-A27-SD09-06C	* ○	63	1.4	8.8	50	27	6	A	0.6	
-063-A22-SD12-05	●	63	1.8	11.7	40	22	5	A	0.5	
-063-A22-SD12-05C	* ●	63	1.8	11.7	40	22	5	A	0.5	
-063-A22-SD12-06	●	63	1.8	11.7	50	22	6	A	0.55	
-063-A27-SD12-05	●	63	1.8	11.7	50	27	5	A	0.6	
-063-A27-SD12-05C	* ●	63	1.8	11.7	50	27	5	A	0.6	
-066-A27-SD12-05C	●	66	1.8	11.7	50	27	5	A	0.56	
-080-A27-SD12-05	●	80	1.8	11.7	63	27	5	A	0.9	
-080-A27-SD12-05C	* ●	80	1.8	11.7	63	27	5	A	0.9	
-080-A27-SD12-06C	●	80	1.8	11.7	50	27	6	A	0.9	
-080-A27-SD12-07	●	80	1.8	11.7	50	27	7	A	0.93	
-080-A27-SD12-08	●	80	1.8	11.7	50	27	8	A	0.92	
-100-B32-SD12-06	●	100	1.8	11.7	50	32	6	B	1.8	
-100-B32-SD12-06C	* ●	100	1.8	11.7	50	32	6	B	1.8	
-080-A27-SD15-05	○	80	2.2	14	50	27	5	A	0.78	
-080-A32-SD15-05	○	80	2.2	14	50	32	5	A	0.72	
-100-B32-SD15-07	○	100	2.2	14	50	32	7	B	1.2	
-125-B40-SD15-09	○	125	2.2	14	63	40	9	B	2.9	
-160-B40-SD15-12	○	160	2.2	14	63	40	12	B	4.4	

● Ex stock / ab Lager ○ On demand / auf Anfrage * With internal cooling · Mit Innenkühlung

Applicable tool
Werkzeug **B11-B18**

Tools code key
Werkzeug ISO **B26-B27**

Grade selection guide
Sortenauswahl **B19-B23**

Technical data
Technische Daten **B236-B241**

Milling · Fräsen

Indexable Milling Tools · Wendepplattenfräser

Spare parts · Ersatzteile

Tool Werkzeug	Insert Screw Schraube	Clamp Screw Schraube	Clamp Pratze	Wrench Schlüssel	
XMR01**-SD06**	I60M2.2×0.8	-	-	WT07IP	
XMR01**-SD09**	I60M3.5×08TT	I60M4×8.4	WD-204	WT10IP	WT15IP
XMR01**-SD12**	I60M4×8.4			WT15IP	



Coupling Aufnahme	Diameter Durchmesser Ø D	Screw-Schraube	Ring-Dichtring
B32	Ø100	LDB32C	B32-002-CP

Applicable inserts · Wendeschneidplatten

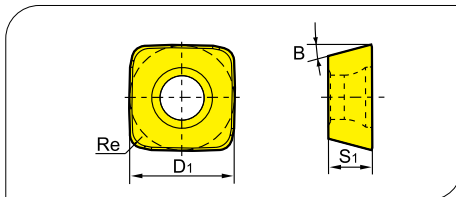

Workpiece Material Werkstoffe	Ideal Machining Condition Gute Bearbeitungsbedingungen			Normal Machining Condition Normale Bearbeitungsbedingungen			Unfavorable Machining Condition Ungünstige Bearbeitungsbedingungen								
	P	M	K	N	S	P	M	K	N	S	P	M	K	N	S
P Steel Stahl	●	●	●	●	●	●	●	●	●	●	●	●	●	●	●
M Stainless Steel Rostfreier Stahl	●	●	●	●	●	●	●	●	●	●	●	●	●	●	●
K Cast iron Gusseisen	●	●	●	●	●	●	●	●	●	●	●	●	●	●	●
N Non-ferrous material Nichte Metalle	●	●	●	●	●	●	●	●	●	●	●	●	●	●	●
S Heat-resistant steel Wärmefester Stahl	●	●	●	●	●	●	●	●	●	●	●	●	●	●	●

Insert WSP	Type Typ	Dimensions (mm) Abmessungen				CVD Coating CVD Beschicht.						PVD Coating PVD Beschicht.						Cermets Cermets	Carbide uncoat. unbe. Hartmetall									
		B	Re	S ₁	D ₁	YBC302	YBC301	YBC401	YBM253	YBM251	YBM351	YBD152	YBD252	YBG102	YBG320	YBG205	YBG202			YBG212	YBG302	YBG152	YBG252	YNG151	YNG151C	YC30S	YD101	YD201
	SDMT06T208-DM	15°	0.8	2.58	6.35						●							●										
	SDMT09T312-DM	15°	1.2	3.97	9.525	●					●	●						●		●								
	SDMT120412-DM	15°	2.0	4.76	12.7	●					●	●						●	●									
	New! SDMT150520-DM	15°	2.0	5.56	15.875														○									
	SDMT06T208-PM	15°	0.8	2.58	6.35	●		●										●										
	SDMT09T312-PM	15°	1.2	3.97	9.525						●	●						●	●									
	SDMT120412-PM	15°	2.0	4.76	12.7						●	●						●	●									
	SDMT150520-PM	15°	2.0	5.56	15.875							○							○									

● Ex Stock / ab Lager ○ On demand / auf Anfrage

High feed milling cutters · Hochvorschubschafffräser

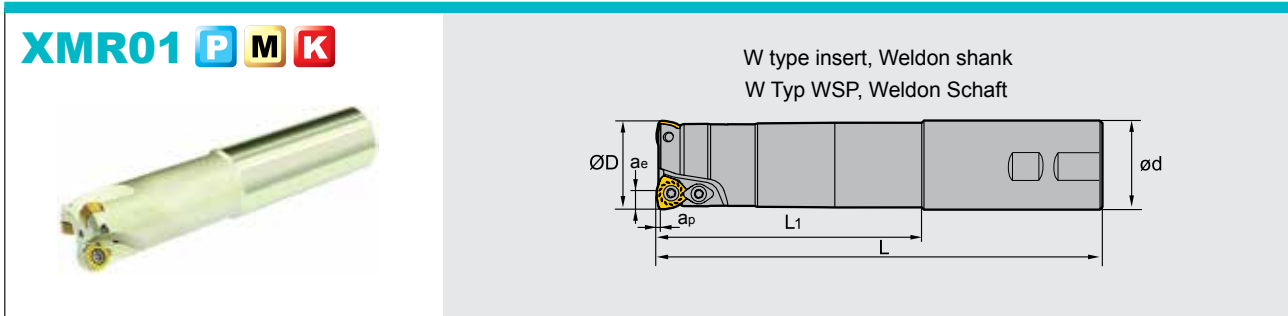





Specification of tools · Werkzeug-Beschreibung

Type Typ	✱	Stock Lager	Dimensions (mm) Abmessungen						No. of teeth Zähne	Weight Gewicht (kg)
			Ø D	ap	ae	L1	L	ø d		
XMR01 -020-XP20-WP05-02-M	✱	●	20	1.5	3.8	50	130	20	2	0.2
-020-XP20-WP05-02-L	✱	●	20	1.5	3.8	100	180	20	2	0.3
-020-XP20-WP05-02-XL	✱	●	20	1.5	3.8	130	250	20	2	0.8
-025-XP25-WP06-02-M	✱	●	25	1.5	4.35	60	140	25	2	0.4
-025-XP25-WP06-02-L	✱	●	25	1.5	4.35	120	200	25	2	0.6
-025-XP25-WP06-02-XL	✱	●	25	1.5	4.35	180	300	25	2	1.0
-032-XP32-WP06-03-M	✱	●	32	1.5	4.35	70	150	32	3	0.8
-032-XP32-WP06-03-L	✱	●	32	1.5	4.35	120	200	32	3	1.0
-032-XP32-WP06-03-XL	✱	●	32	1.5	4.35	180	300	32	3	1.6
-040-XP32-WP06-03-M	✱	●	40	1.5	4.35	50	150	32	3	0.9
-040-XP32-WP06-03-L	✱	●	40	1.5	4.35	50	250	32	3	1.5
-040-XP32-WP06-03-XL	✱	●	40	1.5	4.35	50	300	32	3	1.8
-040-XP32-WP08-02-M	✱	●	40	1.5	5.66	50	150	32	2	0.9
-040-XP32-WP08-02-L	✱	●	40	1.5	5.66	50	250	32	2	1.5
-040-XP32-WP08-02-XL	✱	●	40	1.5	5.66	50	300	32	2	1.9

● Ex stock / ab Lager ○ On demand / auf Anfrage ✱ With internal cooling · Mit Innenkühlung

Spare parts · Ersatzteile

Tool Werkzeug	Clamp/Insert Screw Schraube	Clamp Pratze	Wrench Schlüssel	
	XMR01**-WP05**	 I60M3.5×08TT		 WT10IP
XMR01**-WP06**	I60M4×8.4	--	WT15IP	--
XMR01**-WP08**	I60M5×13	WD-208	--	WT20IT
XMR01**-WP09**				



Applicable tool
Werkzeug **B11-B18**

Tools code key
Werkzeug ISO **B26-B27**

Grade selection guide
Sortenauswahl **B19-B23**

Technical data
Technische Daten **B236-B241**

High feed milling cutters · Hochvorschubfräser



XMR01 P M K

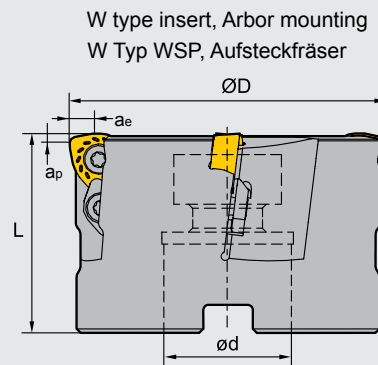

Specification of tools · Werkzeug-Beschreibung

Type Typ	✱	Stock Lager	Dimensions (mm) Abmessungen					No. of teeth Zähne	Inserts WSP	Weight Gewicht (kg)
			Ø D	ap	ae	L	ø d			
XMR01 -050-A22-WP06-04		•	50	1.5	4.35	50	22	4	A	0.4
-050-A22-WP06-04C	✱	•	50	1.5	4.35	50	22	4	A	0.4
-050-A22-WP08-03		•	50	1.5	5.66	50	22	3	A	0.4
-050-A22-WP08-03C	✱	○	50	1.5	5.66	50	22	3	A	0.4
-063-A22-WP08-04		•	63	1.5	5.66	50	22	4	A	0.7
-063-A22-WP08-04C	✱	•	63	1.5	5.66	50	22	4	A	0.7
-063-A27-WP08-04		•	63	1.5	5.66	50	27	4	A	0.7
-063-A27-WP08-04C	✱	○	63	1.5	5.66	50	27	4	A	0.7
-080-A27-WP08-05		•	80	1.5	5.66	63	27	5	A	1.5
-080-A27-WP08-05C	✱	•	80	1.5	5.66	63	27	5	A	1.5
-100-B32-WP08-06		•	100	1.5	5.66	63	32	6	B	2.2
-100-B32-WP08-06C	✱	○	100	1.5	5.66	63	32	6	B	2.2
-125-B40-WP08-07		•	125	1.5	5.66	63	40	7	B	3.5
-125-B40-WP08-07C	✱	•	125	1.5	5.66	63	40	7	B	3.5
-160-B40-WP08-08		○	160	1.5	5.66	63	40	8	B	6.0
-160-B40-WP08-08C	✱	○	160	1.5	5.66	63	40	8	B	6.0
-063-A22-WP09-03		○	63	3.0	6.8	50	22	3	A	0.7
-063-A22-WP09-03C	✱	○	63	3.0	6.8	50	22	3	A	0.7
-080-A27-WP09-04		○	80	3.0	6.8	63	27	4	A	1.4
-080-A27-WP09-04C	✱	○	80	3.0	6.8	63	27	4	A	1.4
-100-B32-WP09-05		•	100	3.0	6.8	63	32	5	B	2.1
-100-B32-WP09-05C	✱	○	100	3.0	6.8	63	32	5	B	2.1
-125-B40-WP09-06		•	125	3.0	6.8	63	40	6	B	3.7
-125-B40-WP09-06C	✱	○	125	3.0	6.8	63	40	6	B	3.7
-160-B40-WP09-07		•	160	3.0	6.8	63	40	7	B	6.3
-160-B40-WP09-07C	✱	○	160	3.0	6.8	63	40	7	B	6.3

Spare parts · Ersatzteile

Tool Werkzeug	Clamp / Insert Screw Pratte / WSP Schraube	Clamp Pratte	Wrench Schlüssel	
XMR01**-WP06**	I60M4×8.4	--	WT15S	--
XMR01**-WP08**	I60M5×13	WD-208	--	WT20IT
XMR01**-WP09**	I60M5×13	WD-208	--	WT20IT

● Ex Stock / ab Lager ○ On demand / auf Anfrage ✱ With internal cooling · Mit Innenkühlung

Applicable inserts · Wendschneidplatten

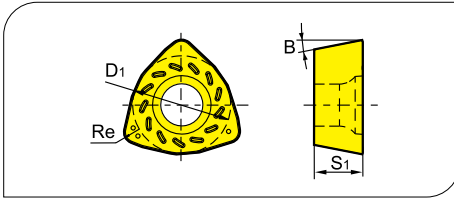

Workpiece Material Werkstoffe	Ideal Machining Condition Gute Bearbeitungsbedingungen			Normal Machining Condition Normale Bearbeitungsbedingungen			Unfavorable Machining Condition Ungünstige Bearbeitungsbedingungen		
	P	M	K	P	M	K	P	M	K
P Steel Stahl	●	●	●	●	●	●	●	●	●
M Stainless Steel Rostfreier Stahl	●	●	●	●	●	●	●	●	●
K Cast iron Gusseisen	●	●	●	●	●	●	●	●	●
N Non-ferrous material Nichtmetalle	●	●	●	●	●	●	●	●	●
S Heat-resistant steel Wärmebeständiger Stahl	●	●	●	●	●	●	●	●	●

Insert WSP	Type Typ	Dimensions (mm) Abmessungen				CVD Coating CVD Beschicht.							PVD Coating PVD Beschicht.				Cermets Cermet	Carbide uncoat. unbe. Hartmetall									
		B	Re	S1	D1	YBC302	YBC301	YBC401	YBM253	YBM251	YBM351	YBD152	YBD252	YBG102	YBG205	YBG202		YBG212	YBG302	YBG152	YBG252	YNG151	YNG151C	YC30S	YD101	YD201	
	WPGT050315ZSR	11°	1.5	3.5	7.94	●					●																
	WPGT060415ZSR	11°	1.5	4.2	9.525	●					●						●	●									
	WPGT080615ZSR	11°	1.5	6.35	12.85	●					●						●	●									
	WPGT090725ZSR	11°	2.5	7	15							●						●	●								
	WPGT050315ZSR-PM	11°	1.5	3.5	7.94												●										
	WPGT060415ZSR-PM	11°	1.5	4.2	9.525	●												●									
	WPGT080615ZSR-PM	11°	1.5	6.35	12.85	●												●									
	WPGT090725ZSR-PM	11°	2.5	7	15													●									

B

Milling Tools
Fräser

Applicable tool
Werkzeug **B11-B18**

Tools code key
Werkzeug ISO **B26-B27**

Grade selection guide
Sortenauswahl **B19-B23**

Technical data
Technische Daten **B236-B241**

Milling - Fräsen

Indexable Milling Tools - Wendeplattenfräser

Approximate R in machining program Ungefährer Programmerradius

Insert WSP	approx. ca. R(mm)	Cutting margin Cutting margin K(mm)
WPGT050315ZSR	2	0.5
WPGT060415ZSR	2.5	0.7
WPGT080615ZSR	2.0	0.7
WPGT090725ZSR	4.0	1.2
SDMT09T312-DM	2.5	0.87
SDMT120412-DM	4.0	0.93

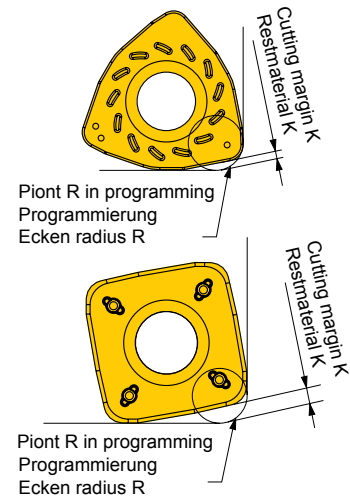

Different machining styles Different machining styles

■ Ramp machining Tauchfräsen

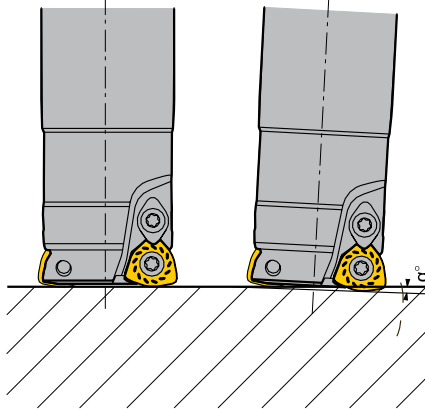

■ Helical interpolation milling Zirkularfräsen

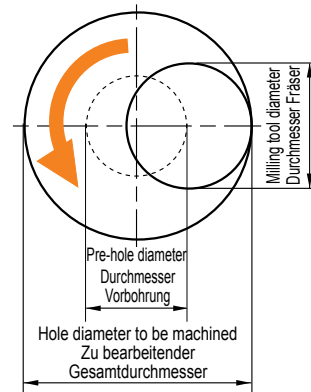

- Reduce the feed rate in ramp and helical machining operations.
- Set the axial feed rate below 0.2mm/rev in drilling operation.
- Be careful ! Long chippings may fly out in drilling operation.
- The cutting depth of each rotation can't exceed the maximum cutting depth (a_p)
- The S type insert not only is applied in the machining operations mentioned above, but also able to be used for plunge milling.

- Beim Tauch- und Zirkularfräsen den Vorschub reduzieren.
- Vorschub bei Bohroperationen (achsial) unter 0,2 mm einstellen.
- "Vorsicht" – Beim Bohren können lange Späne entstehen.
- Die Schnitttiefe pro Rotation kann die maximale Schnitttiefe a_p nicht erreichen.
- Die S-Type Wendschneidplatten können auch für andere Bearbeitungsoperationen eingesetzt werden.

XMR01-Serie XMR01-Serie

XMR01 series tools (install SD**inserts) possess perfect edge strength and excellent economical efficiency, have more advantages in face milling.

XMR01 series tools (install WP**inserts) possess good capability of chip removal, have more advantages in cavity milling.

Werkzeuge mit Schneidplatten (SD**) besitzen ausgezeichnete Schneidkantenstabilität. Sie haben besondere Vorteile beim Planfräsen mit hoher Wirtschaftlichkeit.

Werkzeuge mit Schneidplatten (WP..) haben besondere Vorteile bei der Spanabfuhr und werden bevorzugt Auskoffern eingesetzt.

Recommended Cutting data · Schnittdaten

	Workpiece material Werkstückstoff	Hardness HB Härte	Grade Sorte	Cutting speed Schnitt- geschw. (m/min)	Ø25		Ø30/32/35	
					Axial cutting depth Axial cutting depth	Feed rate per tooth Feed rate per tooth	Axial cutting depth Axial cutting depth	Feed rate per tooth Feed rate per tooth
P	carbon steel Soft steel legierter Kohlenstoffstahl Baustahl	≤HB180 HB180- 280	YBG202	170(120-220)	0.6~1.0	0.8~1.2	0.8~1.2	1.0~1.4
			YBM351	150(100-200)				
	Alloy steel Leg. Stahl Alloy tool steel Leg. Werkzeugstahl	HB280-350 ≤HB350	YBG202	150(100-200)	0.4~0.8	0.8~1.2	0.6~1.0	1.0~1.4
			YBM351	130(80-180)				
	hardened steel gehärteter Stahl	≤HRC35	YBG202	150(100-200)	0.4~0.8	0.6~1.0	0.6~1.0	0.8~1.2
			YBM351	120(80-160)				
M	Stainless steel Rostfreier Stahl	≤HB270	YBG202	150(100-200)	0.6~1.0	0.6~1.0	0.8~1.2	0.8~1.2
			YBM351	120(80-160)				
K	cast Iron Gusseisen	Tensile strength	YBG202	170(120-220)	0.6~1.0	1.0~1.4	0.8~1.2	1.2~1.6
		Tensile strength ≤350MPa	YBM351	150(100-200)				
	Nodular Cast iron Kugelgrafitguss Temperguss	Tensile strength Tensile strength ≤800MPa	YBG202	150(100-200)	0.4~0.8	0.8~1.2	0.6~1.0	1.0~1.4
			YBM351	120(80-160)				

Recommended Cutting data · Schnittdaten

	Workpiece material Werkstückstoff	Hardness HB Härte	Grade Sorte	Cutting speed Schnitt- geschw. (m/min)	Ø40		Ø50/63		Ø80/100	
					Axial cutting depth Axial cutting depth	Feed rate per tooth Feed rate per tooth	Axial cutting depth Axial cutting depth	Feed rate per tooth Feed rate per tooth	Axial cutting depth Axial cutting depth	Feed rate per tooth Feed rate per tooth
P	carbon steel Soft steel legierter Kohlenstoffstahl Baustahl	≤HB180 HB180- 280	YBG202	170(120-220)	0.8~1.2	1.0~1.4	1.1~1.5	1.1~1.5	1.0~1.5	1.0~1.5
			YBM351	150(100-200)						
	Alloy steel Leg. Stahl Alloy tool steel Leg. Werkzeugstahl	HB280-350 ≤HB350	YBG202	150(100-200)	0.6~1.0	1.0~1.4	0.9~1.3	1.1~1.5	0.8~1.3	1.0~1.5
			YBM351	130(80-180)						
	hardened steel gehärteter Stahl	≤HRC35	YBG202	150(100-200)	0.6~1.0	0.8~1.2	0.9~1.3	0.9~1.3	0.8~1.3	0.8~1.3
			YBM351	120(80-160)						
M	Stainless steel Rostfreier Stahl	≤HB270	YBG202	150(100-200)	0.8~1.2	0.8~1.2	1.1~1.5	0.9~1.3	1.0~1.5	0.8~1.3
			YBM351	120(80-160)						
K	cast Iron Gusseisen	Tensile strength	YBG202	170(120-220)	0.8~1.2	1.2~1.6	1.1~1.5	1.3~1.7	1.0~1.5	1.2~1.7
		Tensile strength ≤350MPa	YBM351	150(100-200)						
	Nodular Cast iron Kugelgrafitguss Temperguss	Tensile strength Tensile strength ≤800MPa	YBG202	150(100-200)	0.6~1.0	1.0~1.4	0.9~1.3	1.1~1.5	0.8~1.3	1.0~1.5
			YBM351	120(80-160)						

XMR01

series high feed milling tools
Hochvorschubfräser

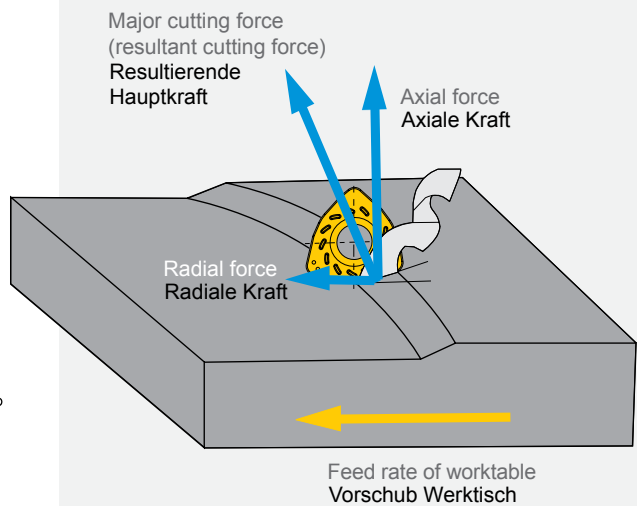
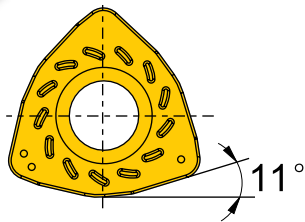

The feature of high feed tool is to resolve the major cutting force into the axial direction, greatly reduce the radial cutting force, thus improve tool's capability of shock resistance. In addition, this structure can effectively reduce the vibration in long overhang milling application.

Merkmale dieses Hochvorschubfräasers ist die Ablenkung der Hauptkraft in axiale Richtung. Dadurch wird die radiale Kraft deutlich verringert, was eine Reduzierung der Vibration ermöglicht und somit lange Standzeiten auch bei größeren Auskräglängen zur Folge hat.



XMP01

Groove milling cutter
Bohrfräsen

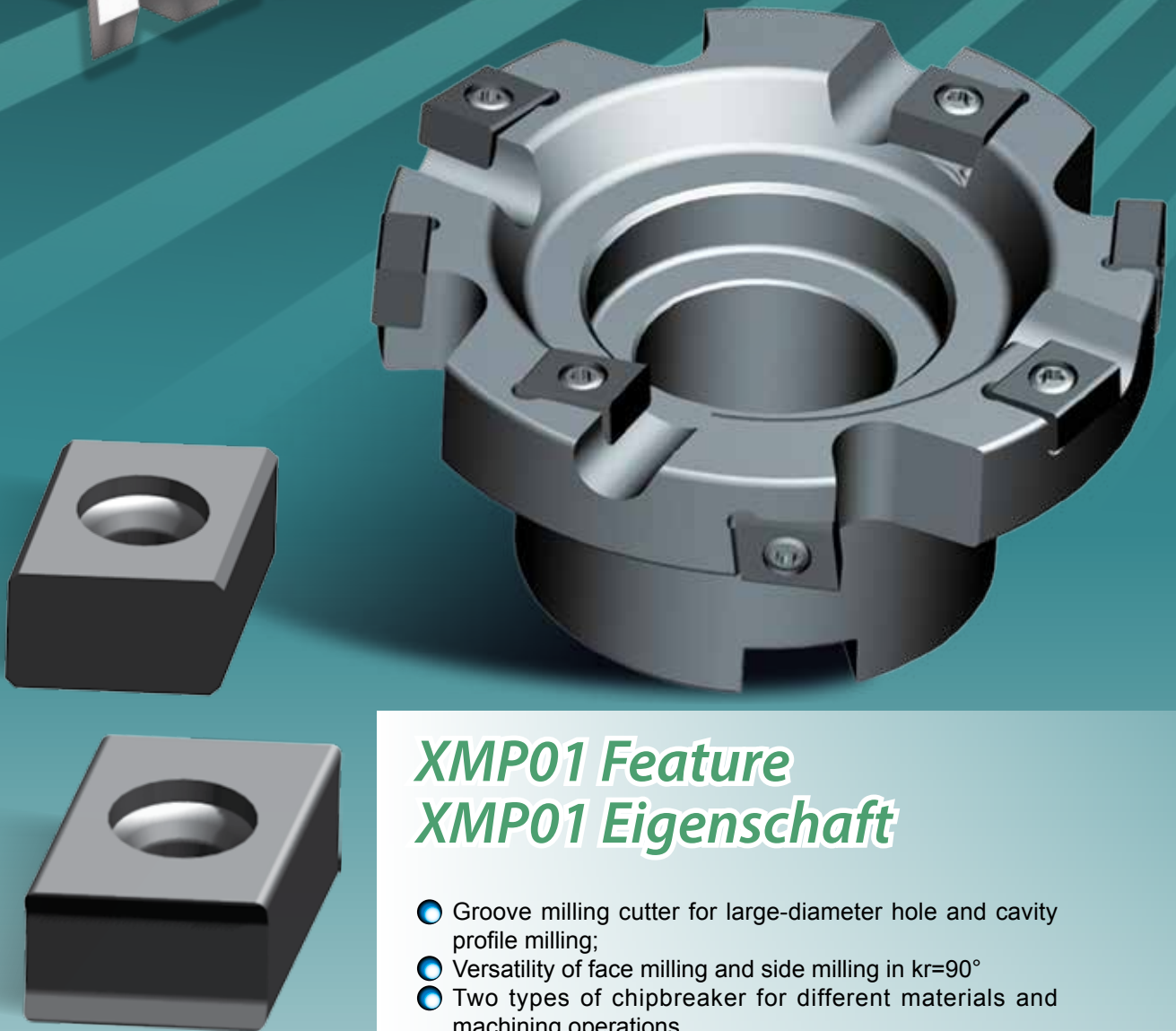

XMP01 Feature *XMP01 Eigenschaft*

- Groove milling cutter for large-diameter hole and cavity profile milling;
- Versatility of face milling and side milling in $kr=90^\circ$
- Two types of chipbreaker for different materials and machining operations.

- Universal Fräser für die Bearbeitung von großen Bohrungen;
- Auch für den Einsatz von Planfräsen und Eckfräsen geeignet;
- Zwei WSP-Geometrien für verschiedene Materialien und Bearbeitungen

Milling · Fräsen

Indexable Milling Tools · Wendepplattenfräser

Boring milling cutters · Bohren und Fräsen



XMP01 P M K

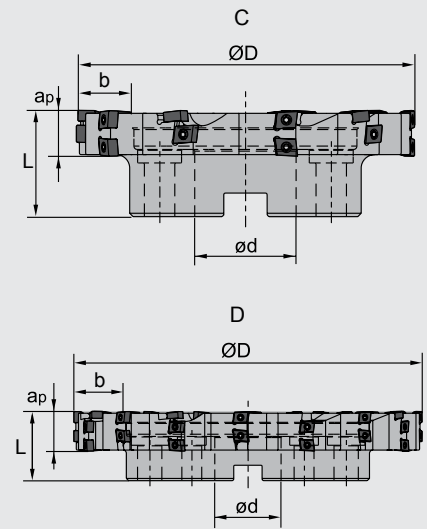
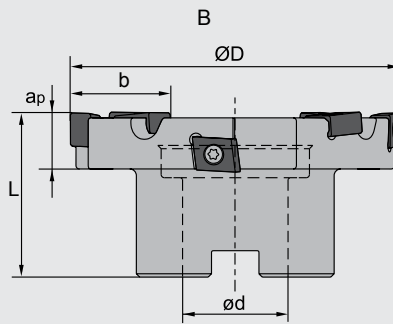

Specification of tools · Werkzeug Beschreibung

Type Typ	Stock Lager	Dimensions (mm) Abmessungen					No. of teeth Zähne Z	Zeff (peripheral teeth/end teeth) (Eckplatte / Planplatte)	Coupling Aufnahme	Weight Gewicht (kg)
		ØD	ød	L	b	ap				
XMP01 -080X18-B27-CNE1210-08	●	80	27	50	18	15	8	2/2	B	0.67
-100X18-B32-CNE1210-08	●	100	32	50	18	20	8	2/2	A	0.99
-125X27-B40-CNE1210-15	●	125	40	63	27	22.5	15	3/2	B	2.46
-160X27-C40-CNE1210-18	●	160	40	63	27	25	18	4/2	C	3.7
-200X27-C60-CNE1210-21	●	200	60	63	27	31.5	21	5/2	C	5.46
-250X36-C60-CNE1210-32	●	250	40	63	36	56.5	32	6/2	C	9.79
-315X36-D60-CNE1210-42	●	315	60	63	36	47.5	42	8/2	D	17.65
-400X36-D60-CNE1210-52	●	400	60	63	36	90	52	10/2	D	27.36

Remark: (1) special ap,b,D possible on request of the Customers

(1) sondere ap,b,D möglich nach Anfrageen

(2) Zeff means the effeptive teeth

(2) Zeff bedeutet die wirkungsvolle zähne

Spare parts · Ersatzteile

Diameter Durchmesser ØD	Insert WSP	Clamp Screw Schraube	Wrench Schlüssel	
Ø80-Ø400	CNE121006*	I60M4X12	WT15IP	

● Ex Stock / ab Lager ○ On demand / auf Anfrage

Applicable inserts · Wendeschneidplatten

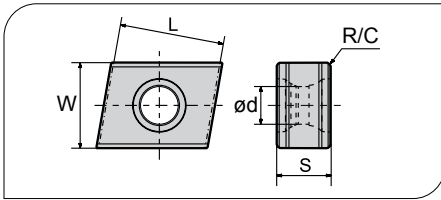

Workpiece Material Werkstoffe	Ideal Machining Condition Gute Bearbeitungsbedingungen			Normal Machining Condition Normale Bearbeitungsbedingungen			Unfavorable Machining Condition Ungünstige Bearbeitungsbedingungen		
	P	M	K	N	S				
P Steel Stahl	●	●	●	●	●	●	●	●	●
M Stainless Steel Rostfreier Stahl	●	●	●	●	●	●	●	●	●
K Cast iron Gusseisen						●	●	●	●
N Non-ferrous material N-Metalle									●
S Heat-resistant steel Warmfester Stahl						●	●	●	●

Insert WSP	Type Typ	Dimensions (mm) Abmessungen					CVD Coating CVD Beschicht.						PVD Coating PVD Beschicht.				Cermets Cermet	Carbide uncoat. unbe. Hartmetall										
		L	W	S	R/C	ød	YBC302	YBC301	YBC401	YBM253	YBM251	YBM351	YBD152	YBD252	YBG102	YB9320		YBG205	YBG202	YBG212	YBG302	YBG152	YBG252	YNG151	YNG151C	YC30S	YD101	YD201
	CNE121006A	12.8	10.0	6.35	0.4	4.4				●																		
	CNE121006B	12.0	10.0	6.35	0.6	4.4				○			●															

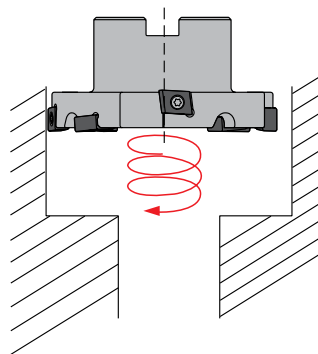

Recommended cutting data · Empfohlene Schnittdaten

Workpiece material Werkstückstoff	Hardness HB Härte	Grade Sorte	Cutting data Schnittdaten				
			V (m/min)	f (mm/zeff)	a _{pmax}		
					CNE121006A	CNE121006B	
P Low-carbon steel Soft steel Niedriglegierter Kohlenstoffstahl Baustahl	≤180	YBM253	270 (220-350)	0.2 (0.15-0.3)	15-90	15-90	
	180-280	YBM253	260 (200-320)	0.2 (0.15-0.3)	15-90	15-90	
	280-350	YBM253	240 (180-300)	0.2 (0.15-0.3)	15-90	15-90	
M stainless steel Edelstahl	≤270	YBM253	230 (180-300)	0.2 (0.1-0.3)	15-90	15-90	
K Cast iron Gusseisen	180-250	YBD152	270 (150-300)	0.2 (0.15-0.3)	15-90	15-90	

Applicable tool
Werkzeug **B11-B18**

Tools code key
Werkzeug ISO **B26-B27**

Grade selection guide
Sortenauswahl **B19-B23**

Technical data
Technische Daten **B236-B241**

T-slot milling tools · T-Nuten Fräser

Kr:90°



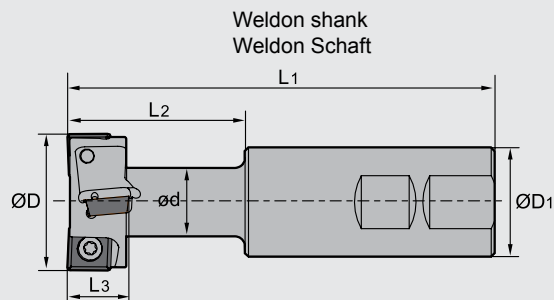

TMP01 **K**



■ Specification of tools · Werkzeug-Beschreibung

Type Typ	Stock Lager	Dimensions (mm) Abmessungen							No. of teeth Zähne	Number of insert Anzahl WSP	T-slot specification für T-Nuten
		Ø D	Ø D ₁	ø d	L ₁	L ₂	L ₃				
TMP01 -021-XP25-MP06-01	●	21	25	10	100	32	9	1	2	12	
-025-XP25-MP06-01	●	25	25	12	100	35	11	1	2	14	
-032-XP32-MP08-02	●	32	32	15	110	45	14	2	4	18	
-040-XP32-MP12-02	●	40	32	19	125	55	18	2	4	22	
-050-XP40-MP12-02	●	50	40	25	140	65	22	2	4	28	
-060-XP50-MP12-02	●	60	50	32	160	80	28	2	6	36	

■ Spare parts · Ersatzteile

Tool Werkzeug	Screw Schraube	Wrench Schlüssel	
			
TMP01-021-XP25-MP06-01	I60M2.5×5.5	WT07IP	--
TMP01-025-XP25-MP06-01	I60M2.5×5.5		
TMP01-032-XP32-MP08-02	I60M3×7	WT10IP	--
TMP01-040-XP32-MP12-02	I60M5×10	--	WT20IT
TMP01-050-XP40-MP12-02	I60M5×10		
TMP01-060-XP50-MP12-02	I60M5×10		



● Ex Stock / ab Lager ○ On demand / auf Anfrage

Applicable inserts · Wendschneidplatten

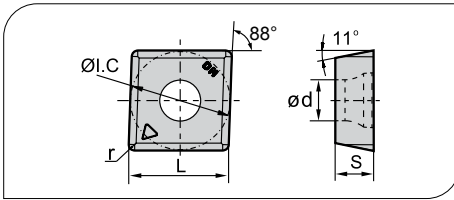

Workpiece Material Werkstoffe	Ideal Machining Condition Gute Bearbeitungsbedingungen			Normal Machining Condition Normale Bearbeitungsbedingungen			Unfavorable Machining Condition Ungünstige Bearbeitungsbedingungen		
	P	M	K	P	M	K	P	M	K
P Steel Stahl	●	●	●	●	●	●	●	●	●
M Stainless Steel Rostfreier Stahl	●	●	●	●	●	●	●	●	●
K Cast iron Gusseisen	●	●	●	●	●	●	●	●	●
N Non-ferrous material Nichtmetalle	●	●	●	●	●	●	●	●	●
S Heat-resistant steel Wärmefester Stahl	●	●	●	●	●	●	●	●	●

Insert WSP	Type Typ	Dimensions (mm) Abmessungen					CVD Coating CVD Beschicht.						PVD Coating PVD Beschicht.				Cermets Cermet	Carbide uncoat. unbe. Hartmetall										
		I.C.	L	s	d	r	YBC302	YBC301	YBC401	YBM253	YBM251	YBM351	YBD152	YBD252	YBG102	YBG20			YBG205	YBG202	YBG212	YBG302	YBG152	YBG252				
	MPHT060304-DM	6.35	6.35	3.18	2.8	0.4	●				●																	
	MPHT080305-DM	8.3	8.3	3.18	3.4	0.5	●				●										●							
	MPHT120408-DM	12.7	12.7	4.76	5.56	0.8	●				●		●								●							

Recommended Cutting data · Schnittdaten

Workpiece material Werkstückstoff	Grade Sorte	Cutting data Schnittdaten		
		V(m/min)	f(mm/z)	Cooling Kühlung
K	YBG302	80~160	0.05~0.2	Wet / Dry Nass/ Trocken

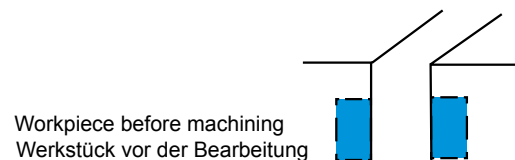

Applicable tool
Werkzeug **B11-B18**

Tools code key
Werkzeug ISO **B26-B27**

Grade selection guide
Sortenauswahl **B19-B23**

Technical data
Technische Daten **B236-B241**

Helical end mill · Walzenstirnfräser

Kr:90°



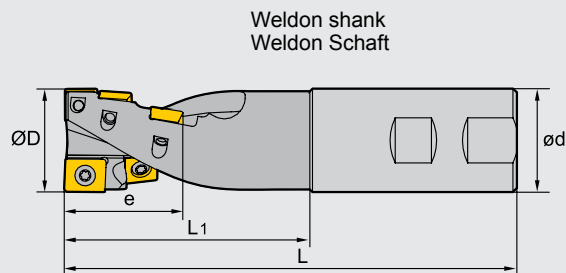
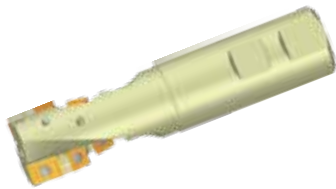

HMP01 P K



Specification of tools · Werkzeug-Beschreibung

Type Typ	Stock Lager		Dimensions (mm) Abmessungen					Number of flute Anzahl Zahnreihen Z	Number of insert Anzahl WSP		Shank type Schaft
	R	L	Ø D	ø d	e	L ₁	L		APKT 150412-**	SPMT 120408-**	
HMP01	●	○	40	40	55	95	175	2	1	5	Weldon
	●	○	50	40	55	95	175	4	2	10	Weldon

Spare parts · Ersatzteile

Diameter Durchmesser Ø D	Screw Schraube	Wrench Schlüssel
Ø40	 I60M5×10	 WT20IS
Ø50	I60M5×13	WT20IS



● Ex Stock / ab Lager ○ On demand / auf Anfrage

Helical end mill · Walzenstirnfräser

Kr:90°



HMP01 P K



JT shank/BT shank (figure is JT shank)
JT Schaft/BT Schaft (Abb. is JT shank)

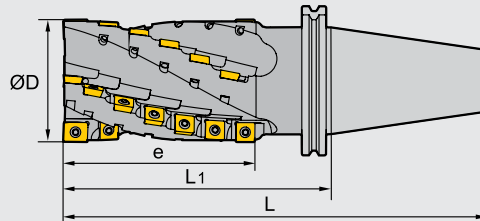

■ Specification of tools · Werkzeug-Beschreibung

Type Typ	Stock Lager		Dimensions (mm) Abmessungen				Number of flute Anzahl Zahnreihen Z	Number of insert Anzahl WSP		Shank type Schaft	
	R	L	Ø D	e	L ₁	L		APKT 150412-**	SPMT 120408-**		
HMP01	-050×84-JT50-SP12-04	○	○	50	84	145	246.75	4	2	16	JT
	-063×74-JT50-SP12-04	○	○	63	74	135	236.75	4	2	14	JT
	-063×104-JT50-SP12-04	●	○	63	104	165	266.75	4	2	20	JT
	-063×134-JT50-SP12-04	○	○	63	134	195	296.75	4	2	26	JT
	-080×104-JT50-SP12-04	○	○	80	104	165	266.75	4	2	20	JT
	-080×144-JT50-SP12-04	○	○	80	144	205	306.75	4	2	28	JT
	-050×84-BT50-SP12-04	○	○	50	84	145	246.8	4	2	16	BT
	-063×74-BT50-SP12-04	●	○	63	74	135	236.8	4	2	14	BT
	-063×104-BT50-SP12-04	○	○	63	104	165	266.8	4	2	20	BT
	-063×134-BT50-SP12-04	○	○	63	134	195	296.8	4	2	26	BT
	-080×104-BT50-SP12-04	○	○	80	104	165	266.8	4	2	20	BT
	-080×144-BT50-SP12-04	●	○	80	144	205	306.8	4	2	28	BT

■ Spare parts · Ersatzteile

Diameter Durchmesser Ø D	Screw Schraube	Wrench Schlüssel	
Ø50	 I60M5×13	 WT20IS	
Ø63	I60M5×13	WT20IS	
Ø80	I60M5×13	WT20IS	

Applicable tool
Werkzeug **B11-B18**

Tools code key
Werkzeug ISO **B26-B27**

Grade selection guide
Sortenauswahl **B19-B23**

Technical data
Technische Daten **B236-B241**

Milling · Fräsen

Indexable Milling Tools · Wendeplattenfräser

Helical endmills with interchangeable heads
Walzenstirnfräser mit austauschbarem Kopf

Kr:90°



HMP01 EC P K

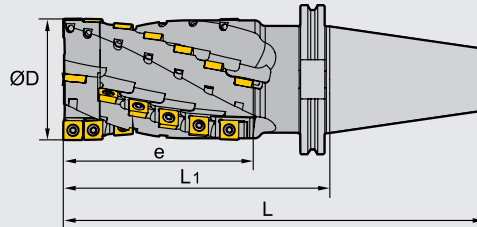

Specification of tools · Werkzeug-Beschreibung

Type Typ	Stock Lager		Dimensions (mm) Abmessungen				Number of flute Anzahl Zahnreihen Z	Number of insert Anzahl WSP		Shank type Schaft	
	R	L	Ø D	e	L ₁	L		APKT 150412-**	SPMT 120408-**		
HMP01	-050×84EC-JT50-SP12-04	●	○	50	84	145	246.75	4	2	16	JT
	-063×74EC-JT50-SP12-04	○	○	63	74	135	236.75	4	2	14	JT
	-063×104EC-JT50-SP12-04	○	○	63	104	165	266.75	4	2	20	JT
	-063×134EC-JT50-SP12-04	●	○	63	134	195	296.75	4	2	26	JT
	-080×104EC-JT50-SP12-04	○	○	80	104	165	266.75	4	2	20	JT
	-080×144EC-JT50-SP12-04	○	○	80	144	205	306.75	4	2	28	JT
	-050×84EC-BT50-SP12-04	○	○	50	84	145	246.8	4	2	16	BT
	-063×74EC-BT50-SP12-04	●	○	63	74	135	236.8	4	2	14	BT
	-063×104EC-BT50-SP12-04	●	○	63	104	165	266.8	4	2	20	BT
	-063×134EC-BT50-SP12-04	●	○	63	134	195	296.8	4	2	26	BT
	-080×104EC-BT50-SP12-04	○	○	80	104	165	266.8	4	2	20	BT
	-080×144EC-BT50-SP12-04	○	○	80	144	205	306.8	4	2	28	BT

Spare parts · Ersatzteile

Diameter Durchmesser Ø D	Insert Screw WSP Schraube	Screw of head Schraube für Kopf	Wrench of insert Screw Schlüssel f. WSP	Wrench of head Schlüssel für Kopf	Interchangeable head Austauschbarer Kopf	
Ø50	I60M5×13	M10×50	WT20IS	WH80L	050EC	
Ø63	I60M5×13	M10×50	WT20IS	WH80L	063EC	
Ø80	I60M5×13	M12×55	WT20IS	WH100L	080EC	

● Ex Stock / ab Lager ○ On demand / auf Anfrage

Applicable inserts · Wendeschneidplatten

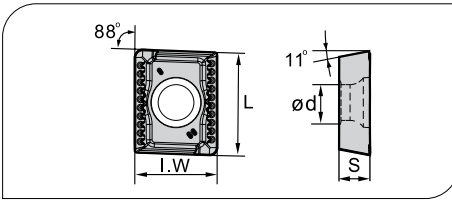

Workpiece Material Werkstoffe	Material	Ideal Machining Condition Gute Bearbeitungsbedingungen			Normal Machining Condition Normale Bearbeitungsbedingungen			Unfavorable Machining Condition Ungünstige Bearbeitungsbedingungen													
		YBC302	YBC301	YBC401	YBM253	YBM251	YBM351	YBD152	YBD252	YBG102	YBG205	YBG202	YBG212	YBG302	YBG152	YBG252	YNG151	YNG151C	YC30S	YD101	YD201
P	Steel Stahl	●	●	●	●	●	●	●	●	●	●	●	●	●	●	●	●	●	●	●	●
M	Stainless Steel Rostfreier Stahl	●	●	●	●	●	●	●	●	●	●	●	●	●	●	●	●	●	●	●	●
K	Cast iron Gusseisen																				
N	Non-ferrous material Nichtmetalle																				
S	Heat-resistant steel Wärmefester Stahl																				

Insert WSP	Type Typ	Dimensions (mm) Abmessungen					CVD Coating CVD Beschicht.						PVD Coating PVD Beschicht.						Cermets Cermet	Carbide uncoat. unbe. Hartmetall							
		L	I.W	S	d	r	YBC302	YBC301	YBC401	YBM253	YBM251	YBM351	YBD152	YBD252	YBG102	YBG205	YBG202	YBG212		YBG302	YBG152	YBG252	YNG151	YNG151C	YC30S	YD101	YD201
	APKT150412-PM	16.33	12.7	4.76	5.4	1.2				●									●								
	APKT150412-KM	16.33	12.7	4.76	5.4	1.2														●							

Applicable inserts · Wendeschneidplatten

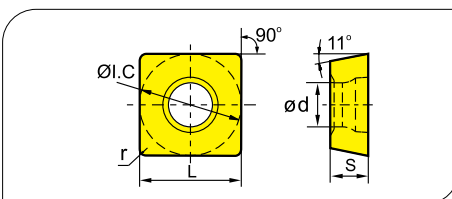

Workpiece Material Werkstoffe	Material	Ideal Machining Condition Gute Bearbeitungsbedingungen			Normal Machining Condition Normale Bearbeitungsbedingungen			Unfavorable Machining Condition Ungünstige Bearbeitungsbedingungen													
		YBC302	YBC301	YBC401	YBM253	YBM251	YBM351	YBD152	YBD252	YBG102	YBG205	YBG202	YBG212	YBG302	YBG152	YBG252	YNG151	YNG151C	YC30S	YD101	YD201
P	Steel Stahl	●	●	●	●	●	●	●	●	●	●	●	●	●	●	●	●	●	●	●	●
M	Stainless Steel Rostfreier Stahl	●	●	●	●	●	●	●	●	●	●	●	●	●	●	●	●	●	●	●	●
K	Cast iron Gusseisen																				
N	Non-ferrous material Nichtmetalle																				
S	Heat-resistant steel Wärmefester Stahl																				

Insert WSP	Type Typ	Dimensions (mm) Abmessungen					CVD Coating CVD Beschicht.						PVD Coating PVD Beschicht.						Cermets Cermet	Carbide uncoat. unbe. Hartmetall							
		L	I.W	S	d	r	YBC302	YBC301	YBC401	YBM253	YBM251	YBM351	YBD152	YBD252	YBG102	YBG205	YBG202	YBG212		YBG302	YBG152	YBG252	YNG151	YNG151C	YC30S	YD101	YD201
	SPMT120408-PM	12.7	12.7	4.76	5.5	0.8				●										●							
	SPMT120408-KM	12.7	12.7	4.76	5.5	0.8															●						

Applicable tool
Werkzeug **B11-B18**

Tools code key
Werkzeug ISO **B26-B27**

Grade selection guide
Sortenauswahl **B19-B23**

Technical data
Technische Daten **B236-B241**

Milling · Fräsen

Indexable Milling Tools · Wendeplattenfräser

A Slot milling
Nutenfräsen

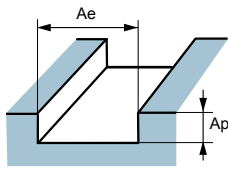

$A_e = D$
 $A_p = 0.5D$ (cast iron/Guss)
Maximum 12mm (steel/Stahl)

B Square shoulder milling
breites Eckfräsen

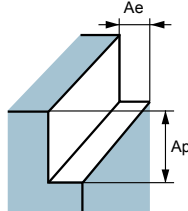

$A_e = 0.5D$
 $A_p = 1.5D$ (cast iron/Guss)
1.0D (steel/Stahl)

C Narrow shoulder milling
schmales Eckfräsen

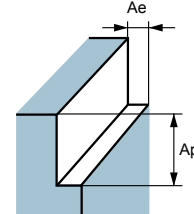

$A_e = 0.1D$
 $A_p \leq$ Maximum cutting length
Maximale Schnittlänge

Recommended Cutting data · Schnittdaten

Workpiece material Werkstückstoff	Hardness HB Härte	Grade Sorte	Cutting data Schnittdaten		Operation (figure/Abb.) Operation (figure/Abb.)
			Cutting speed Schnittgeschw. (m/min)	Feed speed Vorschub (mm/z)	
Low-carbon steel Soft steel niedriglegierter Kohlenstoffstahl Baustahl	≤180	YBG302	80(60-90)	0.25(0.1-0.35)	A
			90(70-120)	0.3(0.15-0.4)	B
			90(70-120)	0.3(0.15-0.4)	C
High-carbon steel hochlegierter Kohlenstoffstahl Alloysteel Leg. Stahl	180-280	YBG302	70(60-100)	0.2(0.1-0.35)	A
			80(60-120)	0.25(0.15-0.35)	B
			90(70-120)	0.25(0.15-0.35)	C
Alloy tool steel Leg. Werkzeugstahl	280-350	YBG302	50(40-80)	0.15(0.08-0.25)	A
			60(50-100)	0.2(0.1-0.35)	B
			70(50-100)	0.2(0.1-0.35)	C
cast Iron Gusseisen	180-250	YBG152 YBG302	70(50-100)	0.2(0.1-0.35)	A
			80(60-120)	0.25(0.15-0.35)	B
			90(80-120)	0.25(0.15-0.35)	C

● Ex Stock / ab Lager ○ On demand / auf Anfrage

Chamfer milling tools · Fasfräser

Kr:30°

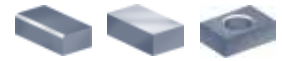

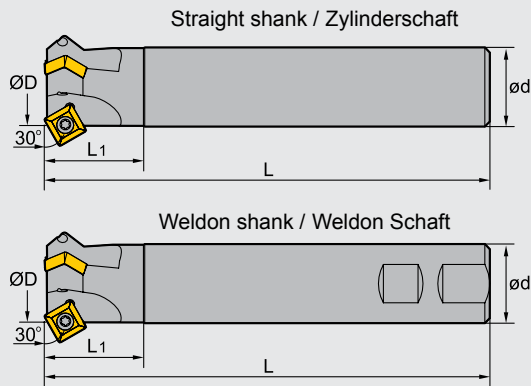

CMZ01 **P** **M** **K**



■ Specification of tools · Werkzeug-Beschreibung

	Type Typ	Stock Lager	Dimensions (mm) Abmessungen				No. of teeth Zähne	Weight Gewicht (kg)
			Ø D	ø d	L	L ₁		
Zylinder- schaft	CMZ01 -012-G20-SP12-01	●	12	20	100	40	1	0.2
	-025-G25-SP12-02	●	25	25	120	40	2	0.8
	-032-G32-SP12-03	●	32	32	180	40	3	1.1
Weldon Schaft	-012-XP20-SP12-01	●	12	20	100	40	1	0.2
	-025-XP25-SP12-02	●	25	25	120	40	2	0.6
Weldon Schaft	-032-XP32-SP12-03	●	32	32	180	40	3	1.0

■ Spare parts · Ersatzteile

Diameter Durchmesser Ø D	Screw Schraube	Wrench Schlüssel
Ø12-Ø32	 I43M5×11	 WT20IS

Applicable tool **B11-B18**
Werkzeug

Tools code key **B26-B27**
Werkzeug ISO

Grade selection guide **B19-B23**
Sortenauswahl

Technical data **B236-B241**
Technische Daten

Kr:45°

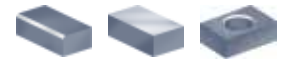

Chamfer milling tools · Fasfräser

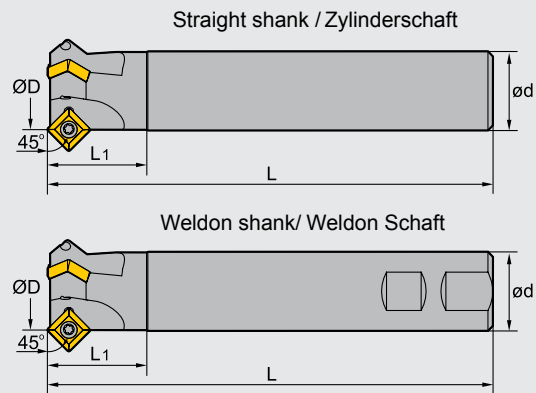

CMA01 P M K



■ Specification of tools · Werkzeug-Beschreibung

	Type Typ	Stock Lager	Dimensions (mm) Abmessungen				No. of teeth Zähne	Weight Gewicht (kg)
			Ø D	ø d	L	L ₁		
CMA01 Straight shank	-012-G20-SP12-01	●	12	20	100	40	1	0.2
	-025-G25-SP12-02	●	25	25	120	40	2	0.8
Zylinder Schaft	-032-G32-SP12-03	●	32	32	180	40	3	1.1
Weldon shank	-012-XP20-SP12-01	●	12	20	100	40	1	0.2
Weldon Schaft	-025-XP25-SP12-02	●	25	25	120	40	2	0.6
	-032-XP32-SP12-03	●	32	32	100	40	3	1.0

■ Spare parts · Ersatzteile

Diameter Durchmesser Ø D	Screw Schraube	Wrench Schlüssel
Ø12-Ø32	 I43M5×11	 WT20IS



● Ex Stock / ab Lager ○ On demand / auf Anfrage

Chamfer milling tools · Fasfräser

Kr:60°

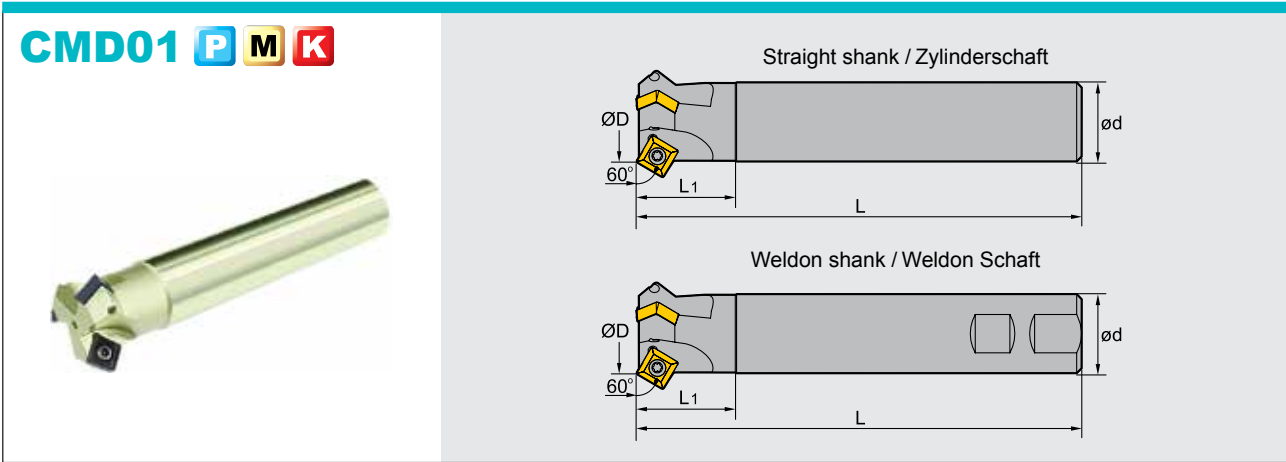
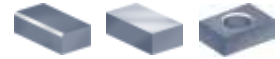

■ Specification of tools · Werkzeug-Beschreibung

	Type Typ	Stock Lager	Dimensions (mm) Abmessungen				No. of teeth Zähne	Weight Gewicht (kg)
			Ø D	ø d	L	L ₁		
CMD01 Straight shank Zylinder Schaft	-012-G20-SP12-01	●	12	20	100	40	1	0.2
	-025-G25-SP12-02	●	25	25	120	40	2	0.8
	-036-G32-SP12-03	●	36	32	180	40	3	1.0
Weldon shank Weldon Schaft	-012-XP20-SP12-01	●	12	20	100	40	1	0.2
	-025-XP25-SP12-02	●	25	25	120	40	2	0.6
	-036-XP32-SP12-03	●	36	32	180	40	3	1.0

■ Spare parts · Ersatzteile

Diameter Durchmesser Ø D	Screw Schraube	Wrench Schlüssel
	Ø12-Ø32	 I43M5×11



Applicable tool
Werkzeug [B11-B18](#)

Tools code key
Werkzeug ISO [B26-B27](#)

Grade selection guide
Sortenauswahl [B19-B23](#)

Technical data
Technische Daten [B236-B241](#)

Milling · Fräsen

Indexable Milling · Fräswendeplatten

Applicable inserts · Wendschneidplatten

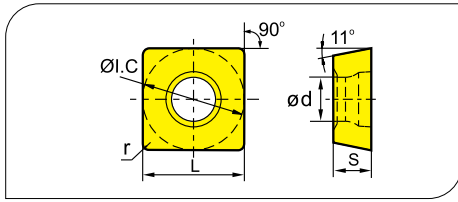

Workpiece Material Werkstoffe	Ideal Machining Condition Gute Bearbeitungsbedingungen			Normal Machining Condition Normale Bearbeitungsbedingungen			Unfavorable Machining Condition Ungünstige Bearbeitungsbedingungen		
	P	M	K	P	M	K	P	M	K
Steel Stahl	●	●	●	●	●	●	●	●	●
Stainless Steel Rostfreier Stahl	●	●	●	●	●	●	●	●	●
Cast iron Gusseisen	●	●	●	●	●	●	●	●	●
Non-ferrous material Nichtmetalle	●	●	●	●	●	●	●	●	●
Heat-resistant steel Wärmebeständiger Stahl	●	●	●	●	●	●	●	●	●

Insert WSP	Type Typ	Dimensions (mm) Abmessungen					CVD Coating CVD Beschicht.					PVD Coating PVD Beschicht.					Cermets Cermets	Carbide uncoat. unbe. Hartmetall									
		I.C.	L	r	S	d	YBC302	YBC301	YBC401	YBM253	YBM251	YBM351	YBD152	YBD252	YBG102	YBG320			YBG205	YBG202	YBG212	YBG302	YBG152	YBG252	YNG1151	YNG151C	
	SPMT120408	12.7	12.7	0.8	4.76	5.5	●	●	●	●																	

Recommended Cutting data · Schnittdaten

Workpiece material Werkstückstoff	Hardness HB Härte	Grade Sorte	Cutting data Schnittdaten	
			Cutting speed Schnittgeschw. (m/min)	Feed speed Vorschub (mm/z)
P Low-carbon steel Soft steel niedriglegierter Kohlenstoffstahl Baustahl High-carbon steel hochlegierter Kohlenstoffstahl Alloy steel Leg. Stahl Alloy tool steel Leg. Werkzeugstahl	≤180	YBM251 YBC301	180(100—250)	0.25 (0.1-0.4)
		YBM351 YBG302 YBC401	150(100—200)	0.3 (0.1-0.5)
		YC30S	120(80—150)	0.4 (0.1-0.5)
	180—280	YBM251 YBC301	160(100—220)	0.3 (0.1-0.4)
		YBM351 YBG302 YBC401	130(100—180)	0.3 (0.1-0.5)
		YC30S	100(60—150)	0.4 (0.1-0.5)
	280—350	YBM251 YBC301	120(80—180)	0.3 (0.1-0.4)
		YBM351 YBG302	100(80—150)	0.3 (0.1-0.5)
		YC30S	80(60—120)	0.4 (0.1-0.5)
M Stainless steel Rostfreier Stahl	≤270	YBM251 YBC301	120(80—180)	0.3 (0.1-0.4)
		YBM351 YBG302 YBC401	100(80—150)	0.3 (0.1-0.5)
		YC30S	80(60—120)	0.4 (0.1-0.5)
K Cast iron Gusseisen	180-250	YBG302	130(100—180)	0.4 (0.1-0.5)

● Ex Stock / ab Lager ○ On demand / auf Anfrage

- Different tool holders in carbide and steel are available for the QCH-SERIES
- Carbide tool holder reduces vibrations and performs very well in high feed operations and in operations where a big overhang is required.
- All exchangeable heads are available with inner coolant hole (except QCH-ZOHX)
- Different connection are available (M8,M10,M12,M16)

- *Verschiede Verlängerungen in Stahl oder Hartmetall sind für die QCH-SERIE verfügbar.*
- *HM- Verlängerung reduziert Vibrationen und steigert die Performance bei hohen Vorschüben und Anwendungen in denen große Auskraglängen benötigt werden.*
- *Alle Austauschköpfe sind für die Anwendung mit Innenkühlung ausgelegt (ausgenommen QCH-ZOHX)*
- *Verschiedene Gewindeanschlüsse sind verfügbar (M8,M10,M12,M16)*

QCH SERIES

QCH SERIE

Steel tool holder
Stahl Verlängerung

Carbide tool holder
Hartmetall Verlängerung

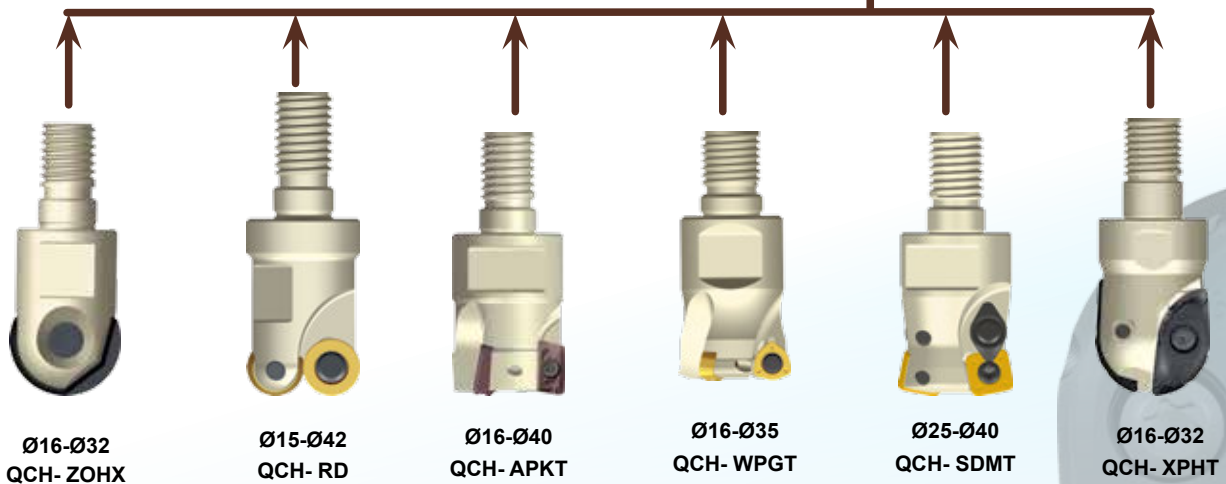

Advantages Vorteile

- Fast tool change reduces setup times
 - Stable force type connection
 - Reduces storage costs
 - Increases flexibility in your machining shop
-
- *Schneller Werkzeugwechsel reduziert Rüstzeit und somit Maschinenstillstand.*
 - *Stabile Kraftschlussverbindung*
 - *Verringerung der Lagerkosten*
 - *Erhöht die Flexibilität in der Fertigung*





Areas of Application

Mold and Die
Automotive Industry
Energy Sector
Aerospace Industry



Anwendungsgebiete

Werkzeug und Formenbau
Automotive
Energiesektor
Luft- & Raumfahrt



Overview QCH milling program Übersicht QCH Fräsprogramm

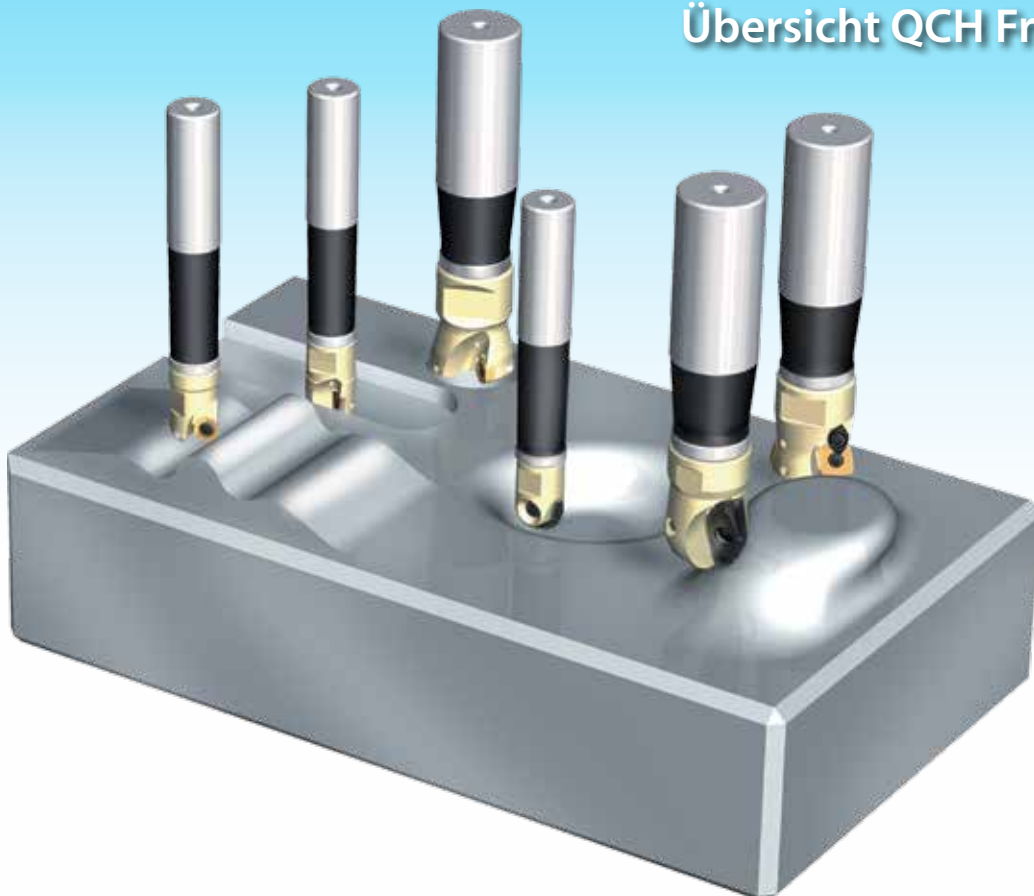

Reassembling with high precision Hohe Wechselgenauigkeit

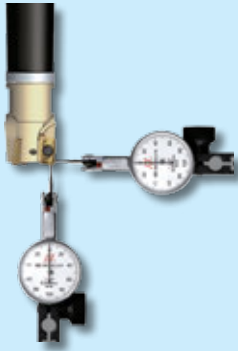

Test radial runout and axial runout with 2 measuring devices.

Vermessung des axialen und radialen Laufs mit 2 Feinzeigern.

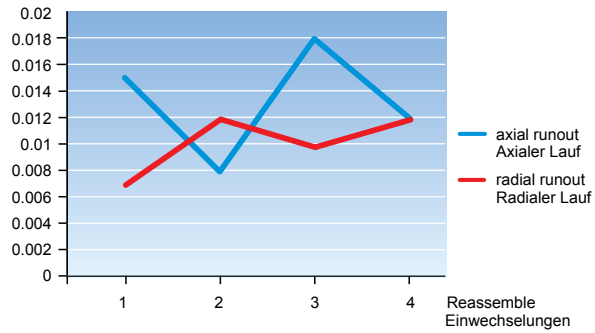

After several of times reassembling, the difference between axial- and radial runout is very small.

Nach mehreren Auswechselungen ist die Abweichung im radialen sowie axialen Lauf nur sehr gering.

Efficient tool Charging
Effizientes Werkzeugwechselln

QCH Tools Replacement
QCH Werkzeugwechsel

Traditional Replacement
Traditionelles Auswechseln



Material Material	1Cr12Ni2MoVNNb-5	
Cooling system Kühlsystem	dry cutting trocken	
Machine Maschine	CNC (HSK63 adapter)	
Cutting data Schnittdaten	$V_c=150\text{m/min}$ $f_z=0.2\text{mm/z}$	$a_p=2\text{mm}$ $a_e=3\text{mm}$
Machining Bearbeitung	bottom and sidewall Grund- und Seitenfläche	

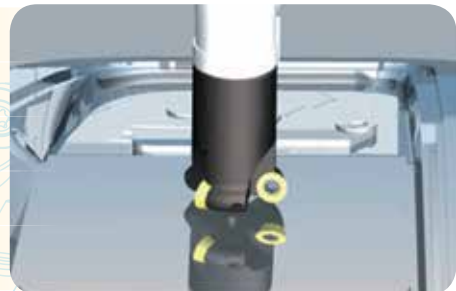

Wear
Verschleiß

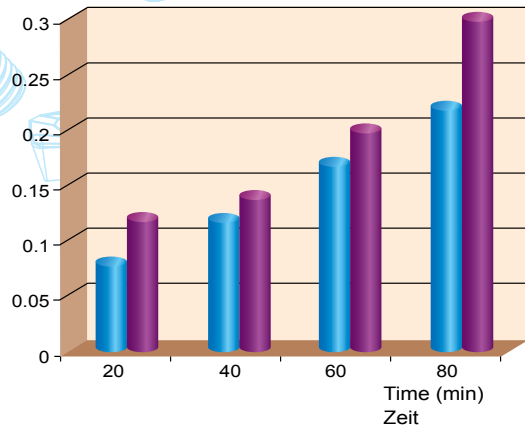

Wear comparison
Verschleißvergleich



ZCC-CT



Competitor A
Wettbewerber A

after 80 min. profile milling
nach 80 Min. Formfräsen

QCH - XPHT

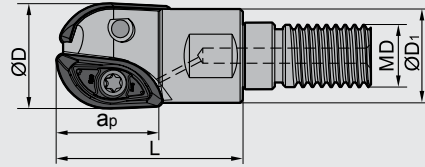
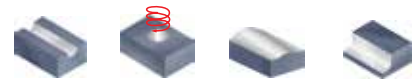

Type Typ	Stock Lager	Dimensions (mm) Abmessungen					Insert WSP	No. of teeth Zähne	Weight Gewicht (kg)
		ØD	ØD1	L	ap	MD			
QCH -16-XPHT16-M10	●	16	17	28	16	10	XPHT16R0803-GM	2	0.036
-20-XPHT20-M12	●	20	19	30	20	12	XPHT20R10T3-GM	2	0.051
-25-XPHT25-M12	●	25	24	35	25	12	XPHT25R1204-GM	2	0.071
-30-XPHT30-M16	●	30	29	45	30	16	XPHT30R1506-GM	2	0.140
-32-XPHT32-M16	●	32	30	45	32	16	XPHT32R1606-GM	2	0.162

Spare parts · Ersatzteile

Diameter Durchmesser Ø D	Screw Schraube	Wrench Schlüssel			
Ø16	I60M2.5×6.5	WT07P	--	--	--
Ø20	I60M3.5×08TT	WT10IP	--	--	--
Ø25	I60M4×10	--	WT15S	--	--
Ø30	I60M5×13.2	--	--	WT20IT	--
Ø32	I60M5×13.2	--	--	--	WT20IT

Applicable inserts · Wendeschneidplatten

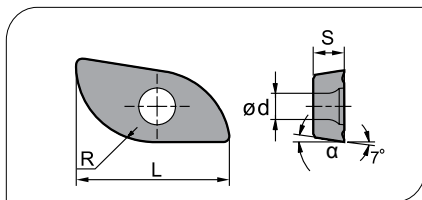

Workpiece Material Werkstoffe	Ideal Machining Condition Gute Bearbeitungsbedingungen			Normal Machining Condition Normale Bearbeitungsbedingungen			Unfavorable Machining Condition Ungünstige Bearbeitungsbedingungen			
	P	M	K	N	S	P	M	K	N	S
P Steel Stahl	●	●	●	●	●	●	●	●	●	●
M Stainless Steel Rostfreier Stahl	●	●	●	●	●	●	●	●	●	●
K Cast iron Gusseisen	●	●	●	●	●	●	●	●	●	●
N Non-ferrite material Ne Metalle	●	●	●	●	●	●	●	●	●	●
S Heat-resistant steel Warmfester Stahl	●	●	●	●	●	●	●	●	●	●

Insert WSP	Type Typ	Dimensions (mm) Abmessungen					CVD Coating CVD Beschicht.					PVD Coating PVD Beschicht.					Cermet Cermet	Carbide uncoat. unbe. Hartmetall											
		L	ød	R	S	α	YBC302	YBC301	YBC401	YBM253	YBM251	YBM351	YBD152	YBD252	YBG102	YB9320			YBG205	YBG202	YBG212	YBG302	YBG152	YBG252	YNG151	YNG151C	YC305	YD101	YD201
	XPHT16R0803-GM	16	3.1	8	3.18	9°																							
	XPHT20R10T3-GM	20	4.0	10	3.97	9°																							
	XPHT25R1204-GM	25	4.7	12.5	4.76	9°																							
	XPHT30R1506-GM	30	5.8	15	6.35	11°																							
	XPHT32R1606-GM	32	5.8	16	6.35	9°																							

● Ex Stock / ab Lager ○ On demand / auf Anfrage

Applicable tool
Werkzeug **B11-B18**

Tools code key
Werkzeug ISO **B26-B27**

Grade selection guide
Sortenauswahl **B19-B23**

Technical data
Technische Daten **B236-B241**

Milling · Fräsen

Indexable Milling Tools · Wendeplattenfräser

Diameter range

Durchmesser Bereich Ø16- Ø20

■ Recommended Cutting data · Schnittdaten

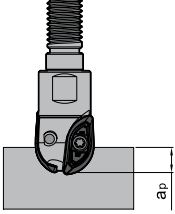
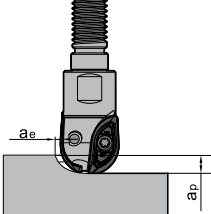
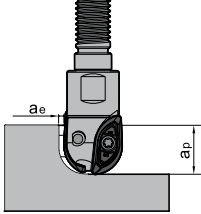
Operations Anwendung						
Workpiece material Werkstückstoff	Cutting data Schnittdaten	Machining of slot Nutenfräsen	Side milling (slight) Schulterfräsen		Side milling (deep) Schulterfräsen	Grade Sorte
Medium carbon steel Kohlenstoffstahl Hardness Härte 150~250HB	V(m/min)	150~220	150~220	150~220	150~220	YBG302
	Fz(mm/z)	0.1~0.4	0.1~0.4	0.1~0.4	0.1~0.4	
	a _p (mm)	4	4	8	16	
	a _e (mm)	--	3	4	1.5	
Alloy steel Leg. Stahl Hardness Härte 150~280HB	V(m/min)	100~150	100~150	100~150	100~150	
	Fz(mm/z)	0.1~0.4	0.1~0.4	0.1~0.4	0.1~0.4	
	a _p (mm)	4	4	8	16	
	a _e (mm)	--	3	4	1.5	
Die steel Gesenkstahl Hardness Härte 150~255HB	V(m/min)	80~120	80~120	80~120	80~120	
	Fz(mm/z)	0.1~0.3	0.1~0.3	0.1~0.3	0.1~0.3	
	a _p (mm)	4	4	8	16	
	a _e (mm)	--	3	4	1.5	
Hardened steel gehärteter Stahl Hardness Härte 40~50HRC	V(m/min)	80~100	80~100	80~100	--	
	Fz(mm/z)	0.08~0.15	0.08~0.15	0.08~0.15	--	
	a _p (mm)	4	4	8	--	
	a _e (mm)	--	2	3	--	
Grey Cast iron Grauguss Hardness Härte 160~260HB	V(m/min)	250~300	250~300	250~300	250~300	
	Fz(mm/z)	0.08~0.15	0.08~0.15	0.08~0.15	0.08~0.15	
	a _p (mm)	4	4	8	16	
	a _e (mm)	--	3	4	1.5	
Nodular Cast iron Kugelgraphitguss Hardness Härte 170~300HB	V(m/min)	200~250	200~250	200~250	200~250	
	Fz(mm/z)	0.08~0.15	0.08~0.15	0.08~0.15	0.08~0.15	
	a _p (mm)	4	4	8	16	
	a _e (mm)	--	3	4	1.5	

B

Milling Tools
Fräser

Diameter range

Durchmesser Bereich Ø25, Ø30, Ø32

Recommended Cutting data · Schnittdaten

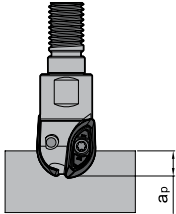
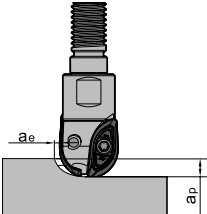
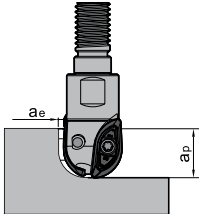
Operations Anwendung						
Workpiece material Werkstückstoff	Cutting data Schnittdaten	Machining of slot Nutenfräsen	Side milling (slight) Schulterfräsen		Side milling (deep) Schulterfräsen	Grade Sorte
Medium carbon steel Kohlenstoffstahl Hardness Härte 150~250HB	V(m/min)	150~220	150~220	150~220	150~220	YBG302
	Fz(mm/z)	0.1~0.4	0.1~0.4	0.1~0.4	0.1~0.4	
	ap(mm)	6	6	12.5	25	
	ae(mm)	--	5	6.5	3	
Alloy steel leg. Stahl Hardness Härte 150~280HB	V(m/min)	100~150	100~150	100~150	100~150	
	Fz(mm/z)	0.1~0.4	0.1~0.4	0.1~0.4	0.1~0.4	
	ap(mm)	6	6	12.5	25	
	ae(mm)	--	5	6.5	3	
Die steel Gesenkstahl Hardness Härte 150~255HB	V(m/min)	80~120	80~120	80~120	80~120	
	Fz(mm/z)	0.1~0.3	0.1~0.3	0.1~0.3	0.1~0.3	
	ap(mm)	6	6	12.5	25	
	ae(mm)	--	5	6.5	3	
Hardened steel gehärteter Stahl Hardness Härte 40~50HRC	V(m/min)	80~100	80~100	80~100	--	
	Fz(mm/z)	0.08~0.15	0.08~0.15	0.08~0.15	--	
	ap(mm)	6	6	12.5	--	
	ae(mm)	--	5	6.5	--	
Grey Cast iron Grauguss Hardness Härte 160~260HB	V(m/min)	250~300	250~300	250~300	250~300	
	Fz(mm/z)	0.08~0.15	0.08~0.15	0.08~0.15	0.08~0.15	
	ap(mm)	6	6	12.5	25	
	ae(mm)	--	5	6.5	3	
Nodular Cast iron Kugelgrafitguss Hardness Härte 170~300HB	V(m/min)	200~250	200~250	200~250	200~250	
	Fz(mm/z)	0.08~0.15	0.08~0.15	0.08~0.15	0.08~0.15	
	ap(mm)	6	6	12.5	25	
	ae(mm)	--	5	6.5	3	

QCH - SDMT

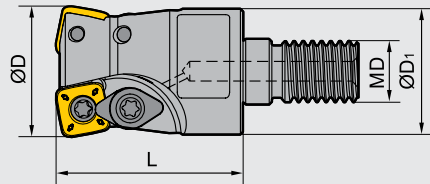

Type Typ	Type Lager	Dimensions (mm) Abmessungen				Insert WSP	No. of teeth Zähne (Z)	Weight Gewicht (kg)	
		ØD	ØD ₁	L	MD				
QCH	-20-SDMT06-M10-03	○	20	19	30	10	SDMT06T208-DM	3	0.058
	-25-SDMT06-M12-04	○	25	24	35	12		4	0.097
	-32-SDMT06-M16-05	○	32	30	45	16		5	0.183
	-25-SDMT09-M12-02	●	25	24	35	12	SDMT09T312-DM	2	0.088
	-30-SDMT09-M16-03	●	30	29	45	16		3	0.176
	-35-SDMT09-M16-03	●	35	30	45	16		3	0.216
	-32-SDMT12-M16-02	●	32	30	45	16	SDMT120412-DM	2	0.175
	-35-SDMT12-M16-02	●	35	30	45	16		2	0.200
	-40-SDMT12-M16-03	●	40	30	45	16		3	0.300

■ Spare parts · Ersatzteile

Diameter Durchmesser Ø D	No. of teeth Zähne (Z)	Clamp screw Schraube	Clamp Pratze	Insert Screw WSPSchraube	Wrench Schlüssel
Ø25	2				
Ø30	3	I60M3.5×08TT	WD-204	I60M4×8.4	WT10IP
Ø32	2	I60M4×8.4	WD-204	I60M4×8.4	WT15IP
Ø35	2				
Ø35	3	I60M3.5×08TT	WD-204	I60M4×8.4	WT10IP



● Ex Stock / ab Lager ○ On demand / auf Anfrage

Applicable inserts · Wendeschneidplatten

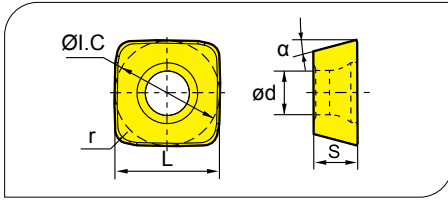

Workpiece Material Werkstoffe	Ideal Machining Condition Gute Bearbeitungsbedingungen			Normal Machining Condition Normale Bearbeitungsbedingungen			Unfavorable Machining Condition Ungünstige Bearbeitungsbedingungen		
	P	M	K	P	M	K	P	M	K
P Steel Stahl	●	●	●	●	●	●	●	●	●
M Stainless Steel Rostfreier Stahl	●	●	●	●	●	●	●	●	●
K Cast iron Gusseisen				●	●	●			●
N Non-ferrous material Nichtmetalle									●
S Heat-resistant steel Wärmefester Stahl				●	●	●	●	●	●

Insert WSP	Type Typ	Dimensions (mm) Abmessungen						CVD Coating CVD Beschicht.						PVD Coating PVD Beschicht.				Cermet Cermet	Carbide uncoat. unbe. Hartmetall										
		Ø1.C	L	ød	S	r	α	YBC302	YBC301	YBC401	YBM253	YBM251	YBM351	YBD152	YBD252	YBG102	YB9320		YBG205	YBG202	YBG212	YBG302	YBG152	YBG252	YNG151	YNG151C	YC30S	YD101	YD201
	SDMT06T208-DM	6.35	6.35	2.5	2.58	0.8	15°						●							●									
	SDMT09T312-DM	9.525	9.525	4.0	3.97	1.2	15°	●					●		●					●		●							
	SDMT120412-DM	12.7	12.7	4.4	4.76	2.0	15°	●					●		●					●		●							
	SDMT06T208-PM	6.35	6.35	5.5	2.58	0.8	15°	●		●									●										
	SDMT09T312-PM	9.525	9.525	1.2	3.97	4.0	15°			●									●	●									
	SDMT120412-PM	12.7	12.7	2.0	4.76	4.4	15°			●									●	●									

Applicable tool
Werkzeug **B11-B18**

Tools code key
Werkzeug ISO **B26-B27**

Grade selection guide
Sortenauswahl **B19-B23**

Technical data
Technische Daten **B236-B241**

QCH - WPGT

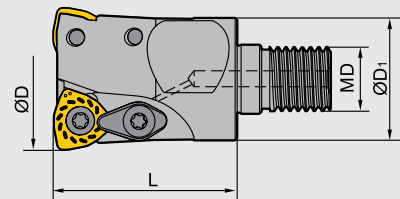
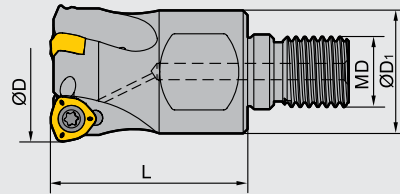

	Type Typ	Type Lager	Dimensions (mm) Abmessungen				Insert WSP	No. of teeth Zähne (Z)	Weight Gewicht (kg)
			ØD	ØD ₁	L	MD			
QCH	-20-WPGT05-M10-02	●	20	18	30	10	WPGT050315ZSR	2	0.056
	-25-WPGT06-M12-02	●	25	21	35	12	WPGT060415ZSR	2	0.097
	-32-WPGT06-M16-03	●	32	29	43	16	WPGT060415ZSR	3	0.185
	-35-WPGT08-M16-02	●	35	30	45	16	WPGT080615ZSR	2	0.196
	-35-WPGT06-M16-03	●	35	30	45	16	WPGT060415ZSR	3	0.201
	-42-WPGT06-M16-04	●	42	29	43	16	WPGT060415ZSR	4	-

■ Spare parts · Ersatzteile

Diameter Durchmesser Ø D	No. of teeth Zähne (Z)	Clamp screw Schraube	Clamp Pratze	Wrench Schlüssel	
Ø20	2	I60M3.5×7	--	WT15	
Ø25	2	I60M4×8.4	--	WT15P	
Ø32	3	I60M4×8.4	--	WT15P	
Ø35	2	I60M5×13	WD-208	WT20IT	
Ø35	3	I60M4×8.4	--	WT15P	

● Ex Stock / ab Lager ○ On demand / auf Anfrage

Applicable inserts · Wendeschneidplatten

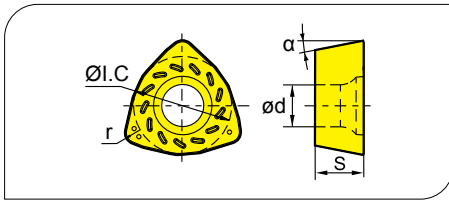

Workpiece Material Werkstoffe	Ideal Machining Condition Gute Bearbeitungsbedingungen			Normal Machining Condition Normale Bearbeitungsbedingungen			Unfavorable Machining Condition Ungünstige Bearbeitungsbedingungen		
	P	M	K	N	S				
P Steel Stahl	●	●	●	●	●	●	●	●	●
M Stainless Steel Rostfreier Stahl	●	●	●	●	●	●	●	●	●
K Cast iron Gusseisen						●	●	●	●
N Non-ferrous material Nichte Metalle									●
S Heat-resistant steel Wärmefester Stahl						●	●	●	●

Insert WSP	Type Typ	Dimensions (mm) Abmessungen					CVD Coating CVD Beschicht.					PVD Coating PVD Beschicht.					Cermet Cermet	Carbide uncoat. unbe. Hartmetall										
		ØI.C	r	S	ød	α	YBC302	YBC301	YBC401	YBM253	YBM251	YBM351	YBD152	YBD252	YBG102	YB9320		YBG205	YBG202	YBG212	YBG302	YBG152	YBG252	YNG151	YNG151C	YC30S	YD101	YD201
	WPGT050315ZSR	7.94	1.5	3.5	4.0	11°	●																					
	WPGT060415ZSR	9.525	1.5	4.2	4.4	11°	●										●		●									
	WPGT080615ZSR	12.85	1.5	6.35	5.5	11°	●																					
	WPGT090725ZSR	15	2.5	7	5.5	11°																						
	WPGT050315ZSR-PM	7.94	1.5	3.5	4.0	11°																						
	WPGT060415ZSR-PM	9.525	1.5	4.2	4.4	11°	●																					
	WPGT080615ZSR-PM	12.85	1.5	6.35	5.5	11°	●																					
	WPGT090725ZSR-PM	15.00	2.5	7.00	5.5	11°																						

Recommended cutting data · Empfohlene Schnittdaten

Workpiece material Werkstück Material	Hardness HB Härte	Grade Sorte	V(m/min)	Ø25		Ø30/32/35								
				Axial cutting depth Axial Schnitttiefe	f (mm/z)	Axial cutting depth Axial Schnitttiefe	f (mm/z)							
P Low-carbon steel Soft steel Niedrig legierter Kohlenstoffstahl Baustahl	≤HB180 HB180-280	YBC302/YBM351	170(120-220) 150(100-200)	0.6~1.0	0.8~1.2	0.8~1.2	1.0~1.4							
								Hoch-carbon steel; Alloysteel Hoch Leg. Kohlenstoffstahl; Leg. Stah	YBC302/YBM351	130(80-180)	0.4~0.8	0.8~1.2	0.6~1.0	1.0~1.4
M Stainless steel Rostfreier Stahl	≤HB270	YBM351	120(80-160)	0.6~1.0	0.6~1.0	0.8~1.2	0.8~1.2							
		YBG205	120(80-190)											
K Cast iron Gusseisen	Tensile strength Zugfestigkeit ≤350MPa	YBG302	150(100-200)	0.6~1.0	1.0~1.4	0.8~1.2	1.2~1.6							
		Nodular cast iron Kugelgrafitguss Temperguss	YBG302					120(80-160)	0.4~0.8	0.8~1.2	0.6~1.0	1.0~1.4		

Applicable tool
Werkzeug **B11-B18**

Tools code key
Werkzeug ISO **B26-B27**

Grade selection guide
Sortenauswahl **B19-B23**

Technical data
Technische Daten **B236-B241**

QCH - APKT



P M K N

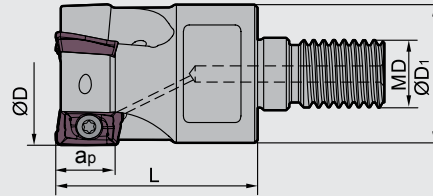

Type Typ	Stock Lager	Dimensions (mm) Abmessungen					Insert WSP	No. of teeth Zähne (Z)	Weight Gewicht (kg)	
		ØD	ØD ₁	L	a _p	MD				
QCH	●	-16-APKT11-M8-02	16	12.5	25	10.5	8	APKT11T3**	2	0.028
	○	-20-APKT11-M10-03	20	18	30	10.5	10		3	0.059
	●	-25-APKT11-M12-04	25	21	35	10.5	12		4	0.104
	●	-32-APKT11-M16-05	32	29	43	10.5	16		5	-
	●	-40-APKT11-M16-06	40	29	43	10.5	16		6	-
	●	-25-APKT16-M12-02	25	21	38	10.5	12		APKT1604**	2
●	-32-APKT16-M16-03	32	29	46	10.5	16	3	-		
●	-40-APKT16-M16-04	40	29	46	10.5	16	4	-		

■ Spare parts · Ersatzteile

Diameter Durchmesser Ø D	No. of teeth Zähne (Z)	Insert Screw Schraube	Wrench Schlüssel	
Ø16	2	I60M2.5×6.5T	WT08IP	
Ø20	3			
Ø25	3			
Ø25	2	I60M4×8.4	WT15IP	
Ø30	3			

● Ex Stock / ab Lager ○ On demand / auf Anfrage

Applicable inserts · Wendeschneidplatten

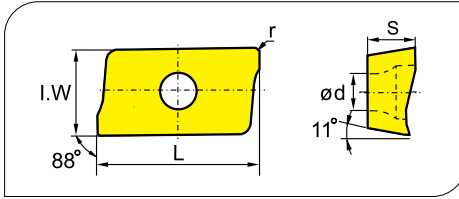

Workpiece Material Werkstoffe	Ideal Machining Condition Gute Bearbeitungsbedingungen			Normal Machining Condition Normale Bearbeitungsbedingungen			Unfavorable Machining Condition Ungünstige Bearbeitungsbedingungen		
	Steel Stahl	Stainless Steel Rostfreier Stahl	Cast iron Gusseisen	Steel Stahl	Stainless Steel Rostfreier Stahl	Cast iron Gusseisen	Steel Stahl	Stainless Steel Rostfreier Stahl	Cast iron Gusseisen
P	•	•	•	•	•	•	•	•	•
M	•	•	•	•	•	•	•	•	•
K	•	•	•	•	•	•	•	•	•
N	•	•	•	•	•	•	•	•	•
S	•	•	•	•	•	•	•	•	•

Insert shape Plattenform	Type Typ	Dimensions (mm) Abmessungen					CVD Coating CVD Beschicht.						PVD Coating PVD Beschicht.						Cermet Cermet	Carbide uncoat. unbe. Hartmetall								
		L	I.W	S	d	r	YBC302	YBC301	YBC401	YBM253	YBM251	YBM351	YBD152	YBD252	YBG102	YB9320	YBG205	YBG202			YBG212	YBG302	YBG152	YBG252	YNG151	YNG151C	YC30S	YD101
	APKT11T304-PF	12.24	6.5	3.6	2.8	0.4	○			•				•														
	APKT11T308-PF	12.24	6.5	3.6	2.8	0.8				•																		
	APKT11T312-PF	12.24	6.5	3.6	2.8	1.2												○										
	APKT11T316-PF	12.24	6.5	3.6	2.8	1.6													•									
	APKT160408-PF	17.877	9.33	5.76	4.4	0.8		•			•	•							•									
	APKT11T304-PM	12.24	6.5	3.6	2.8	0.4	•	•	•		•	•		•														
	APKT11T308-PM	12.24	6.5	3.6	2.8	0.8	•	•		•	•	•	•	•	•													
	APKT11T312-PM	12.24	6.5	3.6	2.8	1.2				•				•														
	APKT11T316-PM	12.24	6.5	3.6	2.8	1.6					•			•														
	APKT160408-PM	17.877	9.33	5.76	4.4	0.8	•	•	•	•	•	•	•	•	•	•												
	APKT160416-PM	17.877	9.33	5.76	4.4	1.6													•									
	APKT11T304-PR	12.24	6.5	3.6	2.8	0.4																						
	APKT11T308-PR	12.24	6.5	3.6	2.8	0.8																						
	APKT11T312-PR	12.24	6.5	3.6	2.8	1.2																						
	APKT11T316-PR	12.24	6.5	3.6	2.8	1.6																						
	APKT160408-PR	17.877	9.33	5.76	4.4	0.8																						
	APKT11T304-LH	12.24	6.5	3.6	2.8	0.4																			•	•		
	APKT11T308-LH	12.24	6.5	3.6	2.8	0.8																			•	•		
	APKT160408-LH	17.877	9.33	5.76	4.4	0.8																			•	•		
	APKT11T304-APF	12.24	6.5	3.6	2.8	0.4																						
	APKT11T308-APF	12.24	6.5	3.6	2.8	0.8																						
	APKT160408-APF	17.877	9.33	5.76	4.4	0.8																						
	APKT11T304-APM	12.24	6.5	3.6	2.8	0.4				•		•		•														
	APKT11T308-APM	12.24	6.5	3.6	2.8	0.8				•		•		•														
	APKT11T312-APM	12.24	6.5	3.6	2.8	1.2				•		•		•														
	APKT11T316-APM	12.24	6.5	3.6	2.8	1.6				•		•		•														
	APKT11T320-APM	12.24	6.5	3.6	2.8	2.0				•		•		•														
	APKT160408-APM	17.877	9.33	5.76	4.4	0.8				•		•	•	•														
	APKT160416-APM	17.877	9.33	5.76	4.4	1.6				•		•		•														
	APKT160420-APM	17.877	9.33	5.76	4.4	2.0				•		•		•														
	APKT160424-APM	17.877	9.33	5.76	4.4	2.4				•		•		•														
APKT160430-APM	17.877	9.33	5.76	4.4	3.0				•		•		•															
	APKT11T304-ALH	12.24	6.5	3.6	2.8	0.4																				•	•	
	APKT11T308-ALH	12.24	6.5	3.6	2.8	0.8																				•	•	
	APKT160408-ALH	17.877	9.33	5.76	4.4	0.8				•																•	•	

Milling · Fräsen

Indexable Milling Tools · Wendeplattenfräser

Chipbreaker Selection EMP01 · Spanbrecher Auswahl EMP01

Application Anwendung	Finishing Schlichten	Semi-Finishing Mittlere Bearbeitung	Roughing Schruppen
P	-PF -APF	-PM -APM	-PR
M	-PF -APF	-PM -APM	-PR
K	-PF	-PM -APM	
AL	-LH -ALH		

1 Square shoulder milling 1 Eckfräsen

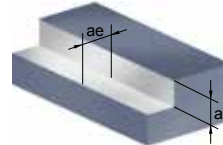

Recommended cutting data · Empfohlene Schnittdaten

Workpiece material Werkstück Material	Hardness HB Härte	Grade Sorte	Cutting data Schnittdaten					
			V(m/min)	f(mm/z)			ae(mm)	
				-PF	-PM	-PR		
P Low-carbon steel Soft steel Niedrig legierter Kohlenstoffstahl Baustahl	≤180	YBM251 YBC301	320 (240-400)	0.1 (0.08-0.2)	0.2 (0.1-0.3)	0.25(0.2-0.35)	≤0.5D	
		YBM351	260 (180-380)	0.1 (0.08-0.2)	0.2 (0.1-0.3)	0.25(0.2-0.35)	≤0.5D	
		YBG202 YBG205	320 (200-400)	0.1 (0.08-0.2)	0.2 (0.1-0.3)	0.25(0.2-0.35)	≤0.5D	
		YBG302	280 (180-400)	0.1 (0.08-0.2)	0.2 (0.1-0.3)	0.25(0.2-0.35)	≤0.5D	
	High-carbon steel Alloy steel Hoch Leg. Kohlenstoffstahl Leg. Stahl	180-280	YBM251 YBC301	280 (210-380)	0.1 (0.08-0.2)	0.2 (0.1-0.3)	0.25(0.2-0.3)	≤0.5D
			YBM351	240 (160-320)	0.1 (0.08-0.2)	0.2 (0.1-0.3)	0.25(0.2-0.35)	≤0.5D
			YBG202 YBG205 YB9320	280 (180-350)	0.1 (0.08-0.2)	0.2 (0.1-0.3)	0.25(0.2-0.3)	≤0.5D
			YBG302	260 (150-380)	0.1 (0.08-0.2)	0.2 (0.1-0.3)	0.25(0.2-0.35)	≤0.5D
	Alloy tool steel Leg. Werkzeugstahl	280-350	YBM251 YBC301	260 (180-350)	0.1 (0.08-0.2)	0.2 (0.1-0.3)	0.25(0.2-0.3)	≤0.5D
			YBM351	220 (150-280)	0.1 (0.08-0.2)	0.2 (0.1-0.3)	0.25(0.2-0.35)	≤0.5D
			YBG202 YBG205 YB9320	260 (160-330)	0.1 (0.08-0.2)	0.2 (0.1-0.3)	0.25(0.2-0.3)	≤0.5D
			YBG302	240 (120-350)	0.1 (0.08-0.2)	0.2 (0.1-0.3)	0.25(0.2-0.35)	≤0.5D
M Stainless steel Rostfreier Stahl	≤270	YBM251	200 (120-270)	0.1 (0.08-0.2)	0.2 (0.1-0.3)	0.25(0.2-0.3)	≤0.5D	
		YBM351 YB9320	180 (150-300)	0.1 (0.08-0.2)	0.2 (0.1-0.3)	0.25(0.2-0.3)	≤0.5D	
		YBG202 YBG205	200 (110-300)	0.1 (0.08-0.2)	0.2 (0.1-0.3)	0.25(0.2-0.3)	≤0.5D	
		YBG302	170 (100-280)	0.1 (0.08-0.2)	0.2 (0.1-0.3)	0.25(0.2-0.3)	≤0.5D	
K Cast iron Gusseisen	180-250	YBG102	220 (120-250)	0.1 (0.08-0.2)	0.2 (0.1-0.3)	-	≤0.5D	
		YBD152	240 (180-300)	-	0.2 (0.1-0.3)	-	≤0.5D	
		YBD252	200 (120-320)	-	0.2 (0.1-0.3)	-	≤0.5D	
N	Al alloy Al Leg.	---	YD101	300-	-LH		0.2 (0.08-0.4)	≤0.5D
			YD201	300-	-LH		0.2 (0.08-0.4)	≤0.5D

2 Slot milling 2 Nutenfräsen

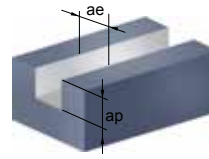

Recommended cutting data · Empfohlene Schnittdaten

Workpiece material Werkstück Material	Hardness HB Härte	Grade Sorte	Cutting data Schnittdaten					
			V(m/min)	f(mm/z)			ae(mm)	
				-PF	-PM	-PR		
P	Low-carbon steel Soft steel Niedrig legierter Kohlenstoffstahl Baustahl	≤180	YBM251 YBC301	190 (170-250)	0.1 (0.08-0.15)	0.15 (0.1-0.25)	0.2 (0.2-0.3)	D
			YBM351	150 (130-210)	0.1 (0.08-0.15)	0.15 (0.1-0.25)	0.2 (0.2-0.3)	D
			YBG202 YBG205 YB9320	190 (140-250)	0.1 (0.08-0.15)	0.15 (0.1-0.25)	0.2 (0.2-0.3)	D
			YBG302	170 (130-250)	0.1 (0.08-0.15)	0.15 (0.1-0.25)	0.2 (0.2-0.3)	D
	High-carbon steel Alloy steel Hoch Leg. Kohlenstoffstahl Leg. Stahl	180-280	YBM251 YBC301	170 (150-220)	0.1 (0.08-0.15)	0.15 (0.1-0.25)	0.2 (0.2-0.3)	D
			YBM351	140 (110-200)	0.1 (0.08-0.15)	0.15 (0.1-0.25)	0.2 (0.2-0.3)	D
			YBG202 YBG205 YB9320	170 (130-250)	0.1 (0.08-0.15)	0.15 (0.1-0.25)	0.2 (0.2-0.3)	D
			YBG302	150 (110-230)	0.1 (0.08-0.15)	0.15 (0.1-0.25)	0.2 (0.2-0.3)	D
	Alloy tool steel Leg. Werkzeugstahl	280-350	YBM251 YBC301	150 (130-210)	0.1 (0.08-0.15)	0.15 (0.1-0.25)	0.2 (0.2-0.3)	D
			YBM351	130 (100-180)	0.1 (0.08-0.15)	0.15 (0.1-0.25)	0.2 (0.2-0.3)	D
			YBG202 YBG205 YB9320	150 (110-240)	0.1 (0.08-0.15)	0.15 (0.1-0.25)	0.2 (0.2-0.3)	D
			YBG302	140 (80-210)	0.1 (0.08-0.15)	0.15 (0.1-0.25)	0.2 (0.2-0.3)	D
M	Stainless steel Rostfreier Stahl	≤270	YBM251	110 (80-190)	0.1 (0.08-0.15)	0.15 (0.1-0.25)	0.2 (0.2-0.3)	D
			YBM351 YB9320	100 (80-170)	0.1 (0.08-0.15)	0.15 (0.1-0.25)	0.2 (0.2-0.3)	D
			YBG202 YBG205	120 (80-190)	0.1 (0.08-0.15)	0.15 (0.1-0.25)	0.2 (0.2-0.3)	D
			YBG302	100 (70-180)	0.1 (0.08-0.15)	0.15 (0.1-0.25)	0.2 (0.2-0.3)	D
K	Cast iron Gusseisen	180-250	YBG102	130 (80-180)	0.1 (0.08-0.15)	0.15 (0.1-0.25)	-	D
			YBD152	140 (80-210)	-	0.15 (0.1-0.25)	-	D
			YBD252	120 (80-210)	-	0.15 (0.1-0.25)	-	D
N	Al alloy Al Leg.	----	YD101 YD201	300-	-LH			D D
					0.2 (0.08-0.3) 0.2 (0.08-0.3)			

Milling · Fräsen

Indexable Milling Tools · Wendeplattenfräser

3 Ramp milling, helical interpolation milling
3 Tauchfräsen, Spiral Interpolationsfräsen

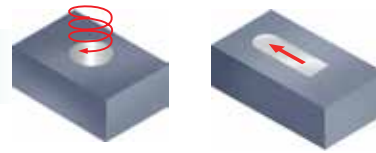

Recommended cutting data · Empfohlene Schnittdaten

Ramp milling Tauchfräsen

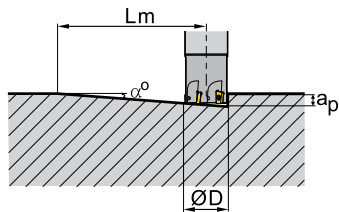

$$L_m = \frac{a_p}{\tan \alpha}$$

(α : Maximum ramp angle)
(α : Maximaler Eintauchwinkel)

Helical interpolation milling Spiral-Interpolationsfräsen

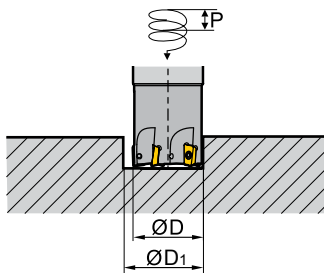

$$\tan \alpha = \frac{P}{\pi D_1}$$

(α : helical angle)
(α : Spiral Winkel)

Diameter Durchmesser Ø D (mm)	APKT Ramp milling, helical interpolation milling (Inserts—11) APKT Tauchfräsen, Spiral-Interpolationsfräsen				
	Ramp milling Tauchfräsen			Helical interpolation milling Spiral-Interpolationsfräsen	
	Max. cutting depth Schnitttiefe a_p (mm)	Max. ramp angle Eintauchwinkel α°	Min. length Länge L_m (mm)	Min. diameter Durchmesser Ø D ₁ (mm)	Max. pitch Steigung (mm)
16	10.0	10.0	56.7	20.0	2.0
20	10.0	5.0	114.4	28.0	2.0
25	10.0	4.5	127.0	40.0	2.0
32	10.0	3.0	190.8	56.0	2.0
40	10.0	2.0	286.4	70.0	2.0

B

Milling Tools
Fräser

NOTES / NOTIZEN :

A series of horizontal dotted lines for taking notes, starting below the 'NOTES / NOTIZEN :' header and extending across the width of the page.

Milling · Fräsen

Indexable Milling Tools · Wendepplattenfräser

QCH - RD

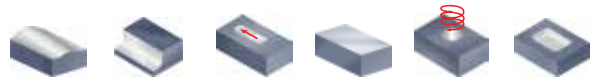

P M K

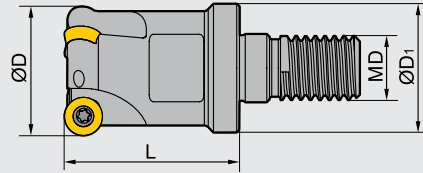

Type Typ	Stock Lager	Dimensions (mm) Abmessungen				Insert WSP	No. of teeth Zähne (Z)	Weight Gewicht (kg)	Coolant Kühlung
		ØD	ØD ₁	L	MD				
QCH -16-RD07-M8-02	○	16	15	25	8	RDKW0702MO	2	0.027	-
-20-RD07-M10-03	●	20	18	30	10		3	0.058	
-25-RD07-M12-03	○	25	21	35	12		3	0.093	
-20-RD10-M10-02	●	20	19	30	10	RDKW10T3MO	2	0.054	
-25-RD10-M12-02	○	25	24	35	12		2	0.097	
-32-RD10-M16-03	○	32	30	45	16		3	0.183	
-32-RD16-M16-02	●	32	30	45	16	RDKW1605MO	2	0.156	

■ Spare parts · Ersatzteile

Insert Durchmesser Ø D	Insert Screw Schraube	Wrench Schlüssel		
RDKW0702MO	I60M2.2×5.5	WT07IP	--	
RDKW10T3MO	I60M4×8	WT15IP	--	
RDKW1605MO	I60M5x13	--	WT20IT	

● Ex Stock / ab Lager ○ On demand / auf Anfrage

Applicable inserts · Wendeschneidplatten

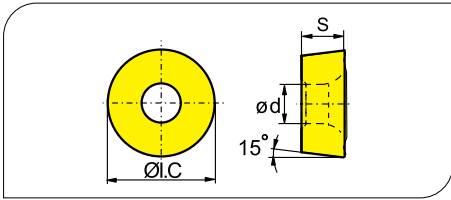

Workpiece Material Werkstoffe	Ideal Machining Condition Gute Bearbeitungsbedingungen			Normal Machining Condition Normale Bearbeitungsbedingungen			Unfavorable Machining Condition Ungünstige Bearbeitungsbedingungen		
	P	M	K	P	M	K	P	M	K
P Steel Stahl	●	●	●	●	●	●	●	●	●
M Stainless Steel Rostfreier Stahl	●	●	●	●	●	●	●	●	●
K Cast iron Gusseisen	●	●	●	●	●	●	●	●	●
N Non-ferrite material Ne Metalle	●	●	●	●	●	●	●	●	●
S Heat-resistant steel Warmfester Stahl	●	●	●	●	●	●	●	●	●

Insert shape Plattenform	Type Typ	Dimension (mm) Abmessung			CVD Coating CVD Beschicht.						PVD Coating PVD Beschicht.				Cermet Cermet	Carbide uncoat. unbe. Hartmetall									
		I.C	S	d	YBC302	YBC301	YBC401	YBM253	YBM251	YBM351	YBD152	YBD252	YBG102	YB9320	YBG205	YBG202	YBG212	YBG302	YBG152	YBG252	YNG151	YNG151C	YC30S	YD101	YD201
	RDKW0702MO-1	7.0	2.38	2.7					●						●										
	RDKW0702MO-2	7.0	2.38	2.7									●												
	RDKW10T3MO	10.0	3.97	4.4	●	○			○				●		●		○								
	RDKW1204MO	12.0	4.76	4.4	●				●	●			●	●	●	●									
	RDKW1605MO	16.0	5.56	5.5						○						●		○							

B

Milling Tools
Fräser

Applicable tool
Werkzeug **B11-B18**

Tools code key
Werkzeug ISO **B26-B27**

Grade selection guide
Sortenauswahl **B19-B23**

Technical data
Technische Daten **B236-B241**

Milling · Fräsen

Indexable Milling Tools · Wendeplattenfräser

QCH - RD

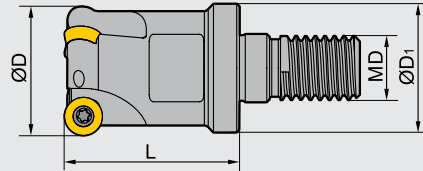
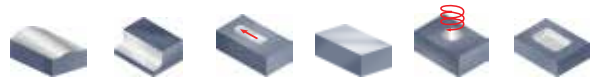

Type Typ	Stock Lager	Dimensions (mm) Abmessungen				Insert WSP	No. of teeth Zähne (Z)	Weight Gewicht (kg)	Coolant Kühlung	
		ØD	ØD ₁	L	MD					
QCH	-15-RDKW0702-M8-02	○	15	12.5	23	8	RDKW0702MO	2	-	Internal cooling Innen Kühlung
	-15-RDKW0702-M8-03	○	15	12.5	23	8		3	-	
	-20-RDKW0702-M10-04	●	20	18	30	10		4	-	
	-25-RDKW0702-M12-05	●	25	21	35	12		5	-	
	-20-RDKW1003-M10-02	●	20	18	30	10	RDKW1003MO	2	-	
	-25-RDKW1003-M12-02	●	25	21	35	12		2	-	
	-25-RDKW1003-M12-03	●	25	21	35	12		3	-	
	-30-RDKW1003-M16-04	●	30	29	43	16		4	-	
	-35-RDKW1003-M16-04	●	35	29	43	16		4	-	
	-42-RDKW1003-M16-05	●	42	29	43	16	5	-		
	-24-RDKW12T3-M12-02	●	24	21	35	12	RDKW12T3MO	2	-	
	-35-RDKW12T3-M16-03	●	35	29	43	16		3	-	
	-42-RDKW12T3-M16-04	●	42	29	43	16		4	-	
	-32-RDKW1604-M16-02	●	32	29	43	16	RDKW1604MO	2	-	

■ Spare parts · Ersatzteile

Insert Durchmesser Ø D	Insert Screw Schraube	Wrench Schlüssel		
RDKW0702MO	I60M2.2×5.5	WT07IP	--	
RDKW1003MO	I60M3.5×7.7	WT15	--	
RDKW12T3MO	I60M3.5×7.7	WT15	--	
RDKW1604MO	I60M4.5×10	WT20	--	

● Ex Stock / ab Lager ○ On demand / auf Anfrage

Applicable inserts · Wendeschneidplatten

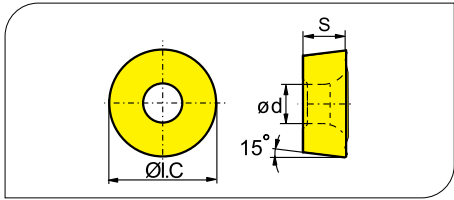

Workpiece Material Werkstoffe	Ideal Machining Condition Gute Bearbeitungsbedingungen			Normal Machining Condition Normale Bearbeitungsbedingungen			Unfavorable Machining Condition Ungünstige Bearbeitungsbedingungen			
	P	M	K	N	S					
P Steel Stahl	●	●	●	●	●	●	●	●	●	●
M Stainless Steel Rostfreier Stahl	●	●	●	●	●	●	●	●	●	●
K Cast iron Gusseisen						●	●	●	●	●
N Non-ferrous material Nichte Metalle										●
S Heat-resistant steel Wärmefester Stahl						●	●	●	●	●

Insert shape Plattenform	Type Typ	Dimension (mm) Abmessung			CVD Coating CVD Beschicht.						PVD Coating PVD Beschicht.						Cermet Cermet	Carbide uncoat. unbe. Hartmetall								
		I.C	S	d	YBC302	YBC301	YBC401	YBM253	YBM251	YBM351	YBD152	YBD252	YBG102	YB9320	YBG205	YBG202	YBG212	YBG302	YBG152	YBG252	YNG151	YNG151C	YC30S	YD101	YD201	
	RDKW0702MO-1	7.0	2.38	2.7						●																
	RDKW0702MO-2	7.0	2.38	2.7								●														
	RDKW1003MO-1	10.0	3.18	3.9					●	●				●	●	●										
	RDKW1003MO-2	10.0	3.18	3.9								●														
	RDKW1003MO-3	10.0	3.18	3.9				●							●											
	RDKW12T3MO-1	12.0	3.97	3.9					●	●				●	●	●										
	RDKW12T3MO-2	12.0	3.97	3.9									●		○										●	
	RDKW12T3MO-3	12.0	3.97	3.9				●							●											
	RDKW1604MO-1	16.0	4.76	5.2						●				●	●	●				●						
	RDKW1604MO-2	16.0	4.76	5.2									●													
	RDKW1604MO-3	16.0	4.76	5.2	●	●		●				●	●	●					●							

-1 normale Fase/ standard chamfer -2 kleine Fase/ small chamfer -3 große Fase/ large chamfer

Recommended cutting data · Empfohlene Schnittdaten

Workpiece material Werkstück Material	Hardness HB Härte	Grade Sorte	V(m/min)	f(mm/z)	a _{pmax} (mm)							
					RDKW07**		RDKW10**		RDKW12**		RDKW16**	
					a _z	a _p	a _z	a _p	a _z	a _p	a _z	a _p
P Low-carbon steel Soft steel Niedrig legierter Kohlenstoffstahl Baustahl	≤180	YBM351 YBG302	220 (180-300)	0.25 (0.15-0.3)	1.6	3.5	2.3	5	3.3	6	3.9	8
		YBG202 YBM251	270 (200-360)	0.2 (0.1-0.3)	1.6	3.5	2.3	5	3.3	6	3.9	8
	180-280	YBM351 YBG302	200 (160-280)	0.25 (0.15-0.3)	1.6	3.5	2.3	5	3.3	6	3.9	8
		YBG202 YBM251 YB9320	240 (180-350)	0.2 (0.1-0.3)	1.6	3.5	2.3	5	3.3	6	3.9	8
Alloy tool steel Leg. Stahl	280-350	YBM351 YBG302 YB9320	180 (150-250)	0.25 (0.15-0.3)	1.6	3.5	2.3	5	3.3	6	3.9	8
		YBG202 YBM251	220 (170-340)	0.2 (0.1-0.3)	1.6	3.5	2.3	5	3.3	6	3.9	8
M Stainless steel Rostfreier Stahl	≤270	YBM351 YBG302	150 (100-220)	0.25 (0.1-0.3)	1.6	3.5	2.3	5	3.3	6	3.9	8
		YBG202 YBM251 YB9320	160 (110-270)	0.2 (0.1-0.3)	1.6	3.5	2.3	5	3.3	6	3.9	8
K Cast iron Gusseisen	180-250	YBG202 YBM251	210 (120-300)	0.2 (0.1-0.3)	1.6	3.5	2.3	5	3.3	6	3.9	8

Applicable tool
Werkzeug **B11-B18**

Tools code key
Werkzeug ISO **B26-B27**

Grade selection guide
Sortenauswahl **B19-B23**

Technical data
Technische Daten **B236-B241**

Milling · Fräsen

Indexable Milling Tools · Wendeplattenfräser

QCH - ZOHX



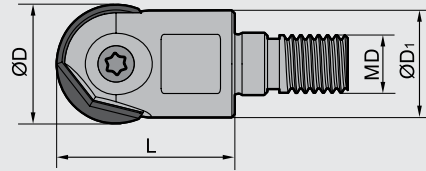

P M K N S



Type Typ	Stock Lager	Dimensions (mm) Abmessungen				Insert WSP	Weight Gewicht (kg)
		ØD	ØD ₁	L	MD		
QCH -16-ZOHX16-M8	●	16	15	28	8	ZOHX1604- **	0.029
-20-ZOHX20-M10	●	20	19	30	10	ZOHX2005- **	0.048
-25-ZOHX25-M12	●	25	24	35	12	ZOHX2506- **	0.087
-30-ZOHX30-M16	●	30	29	45	16	ZOHX3007- **	0.170
-32-ZOHX32-M16	●	32	30	45	16	ZOHX3207- **	0.180

■ Spare parts · Ersatzteile

Diameter Durchmesser Ø D	Insert Screw Schraube	Wrench Schlüssel	
			
Ø16	I70M5×12TT	WT20IP	--
Ø20	I70M5×16TT	WT20IP	--
Ø25	I70M6×20TT	WT20IP	--
Ø30	I70M8×25TT	--	WT30IT
Ø32	I70M8×25TT	--	WT30IT



● Ex Stock / ab Lager ○ On demand / auf Anfrage

Applicable inserts · Wendeschneidplatten

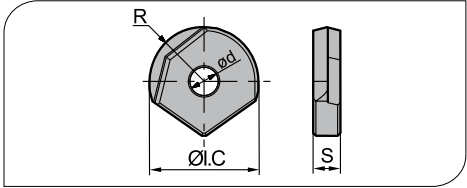

Workpiece Material Werkstoffe	Ideal Machining Condition Gute Bearbeitungsbedingungen			Normal Machining Condition Normale Bearbeitungsbedingungen			Unfavorable Machining Condition Ungünstige Bearbeitungsbedingungen		
	P	M	K	P	M	K	P	M	K
P Steel Stahl	●	●	●	●	●	●	●	●	●
M Stainless Steel Rostfreier Stahl	●	●	●	●	●	●	●	●	●
K Cast iron Gusseisen	●	●	●	●	●	●	●	●	●
N Non-ferrous material Nichtmetalle	●	●	●	●	●	●	●	●	●
S Heat-resistant steel Wärmebeständiger Stahl	●	●	●	●	●	●	●	●	●

Insert WSP	Type Typ	Dimensions (mm) Abmessungen				CVD Coating CVD Beschicht.				PVD Coating PVD Beschicht.				Cermets Cermet	Carbide uncoat. unbe. Hartmetall											
		ØI.C	ød	S	R	YBC302	YBC301	YBC401	YBM253	YBM251	YBM351	YBD152	YBD252			YBG102	YBG320	YBG205	YBG202	YBG212	YBG302	YBG152	YBG252	YNG151	YNG151C	YC30S
	ZOHX1604-GF	16	5	4	8																					
	ZOHX2005-GF	20	5	5	10																					
	ZOHX2506-GF	25	6	6	12.5																					
	ZOHX3007-GF	30	8	7	15																					
	ZOHX3207-GF	32	8	7	16																					
	ZOHX1604-GM	16	5	4	8																					
	ZOHX2005-GM	20	5	5	10																					
	ZOHX2506-GM	25	6	6	12.5																					
	ZOHX3007-GM	30	8	7	15																					
	ZOHX3207-GM	32	8	7	16																					

Recommended cutting data · Empfohlene Schnittdaten

Workpiece material Werkstück Material	Hardness HB Härte	Cutting data Sorte	Diameter (mm) Durchmesser ØD			Grade Sorte	
			Ø16, Ø20	Ø25	Ø30, Ø32		
P	Carbon steel Niedrig legierter Kohlenstoffstahl Baustahl	V _c (m/min)	100~200	100~200	100~200	YBG252	
		f _z (mm/z)	0.15~0.25	0.2~0.3	0.2~0.3		
		a _{pmax} (mm)	0.8	1	1.25		
		a _{emax} (mm)	0.8	1	1.25		
	Alloy steel Hoch Leg. Kohlenstoffstahl; Leg. Stah	HB180~280	V _c (m/min)	80~180	80~180		80~180
		f _z (mm/z)	0.15~0.25	0.2~0.3	0.2~0.3		
		a _{pmax} (mm)	0.8	1	1.25		
		a _{emax} (mm)	0.8	1	1.25		
	Hardened steel Leg. Stahl	HRC55~65	V _c (m/min)	60~100	60~100		60~100
		f _z (mm/z)	0.15~0.25	0.2~0.3	0.2~0.3		
		a _{pmax} (mm)	0.4	0.5	0.6		
		a _{emax} (mm)	0.4	0.5	0.6		
M	Stainless steel Rostfreier Stahl	HB≤270	V _c (m/min)	70~150	70~150		
		f _z (mm/z)	0.1~0.2	0.1~0.25	0.1~0.25		
		a _{pmax} (mm)	0.6	0.8	1		
		a _{emax} (mm)	0.6	0.8	1		
K	Cast iron Gusseisen	HB180-250	V _c (m/min)	160~300	160~300		
		f _z (mm/z)	0.2~0.3	0.25~0.35	0.25~0.35		
		a _{pmax} (mm)	1	1.5	1.8		
		a _{emax} (mm)	1	1.5	1.8		

Applicable tool
Werkzeug **B11-B18**

Tools code key
Werkzeug ISO **B26-B27**

Grade selection guide
Sortenauswahl **B19-B23**

Technical data
Technische Daten **B236-B241**

Milling · Fräsen

Indexable Milling Tools · Wendeplattenfräser

Solid carbide extensions · Hartmetall Verlängerung

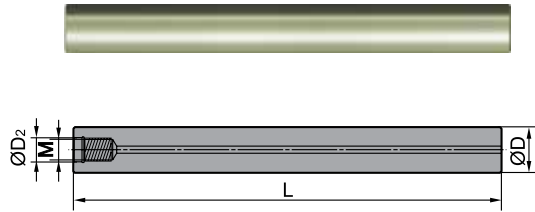

Type 1
Typ

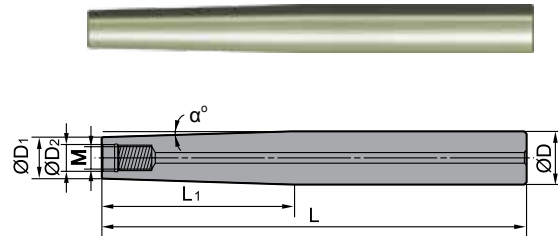

Type 1
Typ

Type Typ	*	Stock Lager	Type Typ	Dimensions (mm) Abmessungen						
				L	M	ØD ₂	ØD	ØD ₁	L ₁	α°
G16-QCH-M8-100C	*	○	1	100	M8	8.5	16	--	--	--
G16-QCH-M8-150C	*	○		150			16	--	--	--
G20-QCH-M8-200C-ZJ90	*	○	2	200	M8	8.5	20	15.5	90	1.3°
G20-QCH-M8-250C-ZJ115	*	○		250			20	15.5	115	1°
G20-QCH-M8-300C-ZJ135	*	○		300			20	15.5	135	0.85°
G20-QCH-M10-100C	*	○	1	100	M10	10.5	20	--	--	--
G20-QCH-M10-150C	*	○		150			20	--	--	--
G20-QCH-M10-200C	*	○	2	200	M10	10.5	20	20	--	--
G25-QCH-M10-200C-ZJ90	*	○		200			25	19.8	90	1.6°
G25-QCH-M10-250C-ZJ115	*	○		250			25	19.8	115	1.25°
G25-QCH-M10-300C-ZJ135	*	○	300	25	19.8	135	1.1°			
G25-QCH-M12-100C	*	○	1	100	M12	12.5	25	--	--	--
G25-QCH-M12-150C	*	○		150			25	--	--	--
G25-QCH-M12-200C	*	○	2	200	M12	12.5	25	--	--	--
G25-QCH-M12-200C-ZJ90	*	○		200			32	24.5	90	2.3°
G25-QCH-M12-250C-ZJ115	*	○		250			32	24.5	115	1.75°
G25-QCH-M12-300C-ZJ135	*	○	300	32	24.5	135	1.5°			
G32-QCH-M16-150C	*	○	1	150	M16	17	32	--	--	--
G32-QCH-M16-200C	*	○		200			32	--	--	--
G32-QCH-M16-250C	*	○	2	250	M16	17	32	--	--	--
G32-QCH-M16-300C	*	○		300			32	--	--	--
G32-QCH-M16-200C-ZJ90	*	○		200			32	30	90	0.64°
G32-QCH-M16-250C-ZJ115	*	○	250	32	30	115	0.5°			
G32-QCH-M16-300C-ZJ135	*	○	300	32	30	135	0.4°			

● Ex Stock / ab Lager ○ On demand / auf Anfrage * With internal cooling · Mit Innenkühlung

Steel extensions · Stahl Verlängerung

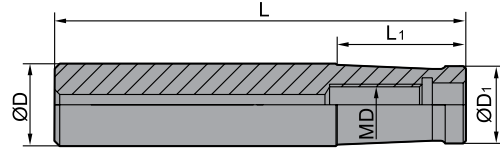

Type Typ	*	Stock Lager	Dimensions (mm) Abmessungen				
			ØD	L	L ₁	ØD ₁	MD
G16-QCH-M8-80	*	●	16	80	25	15	M8
G16-QCH-M8-100	*	●	16	100	45	15	M8
G20-QCH-M10-90	*	●	20	90	35	18.5	M10
G20-QCH-M10-105	*	●	20	105	50	18.5	M10
G25-QCH-M12-90	*	●	25	90	30	24	M12
G25-QCH-M12-110	*	●	25	110	50	24	M12
G32-QCH-M16-100	*	●	32	100	35	28.5	M16
G32-QCH-M16-120	*	●	32	120	55	28.5	M16
G32-QCH-M16-115	*	●	32	115	40	30	M16
G32-QCH-M16-135	*	●	32	135	60	30	M16

● Ex stock / ab Lager ○ On demand / auf Anfrage * With internal cooling · Mit Innenkühlung



Applicable tool
Werkzeug [B11-B18](#)

Tools code key
Werkzeug ISO [B26-B27](#)

Grade selection guide
Sortenauswahl [B19-B23](#)

Technical data
Technische Daten [B236-B241](#)

Milling · Fräsen

Indexable Milling Tools · Wendeplattenfräser

Inserts - face milling · WSP - Planfräsen



SEET-CF SEET-CM SEET-CR SEET-DF SEET-DM SEET-DR SEET-EF SEET-EM

Page Seite B220 B220 B220 B220 B220 B220 B220 B220



SEET-LH SEET-W SEKN/SEEN SEKR SNKN OFKT-DF OFKT-DM OFKT-LH

Page Seite B220 B220 B222 B222 B223 B211 B211 B211



OFKR-DF / DM OFKR-LH ONHU-PF/PM ONHU-GM ONHU-W SNEG-GM/GR/E SNEG-W HNEX-DF

Page Seite B211 B211 B212 B212 B212 B223 B223 B208



HNEX-DM HNEX-DR HNGX-MR HNGX-HDR PNEG-CF/CM/CR PNEG-PF/PM/PR LNKT-ZR LNE32.534 / 32.302

Page Seite B208 B208 B208 B208 B213 B213 B209 B209



LNCX SPKW SPKT SPAN/SPCN SPKN SPKR-GM SPEX SPMR

Page Seite B210 B226 B228 B224 B225 B226 B227 B228



SPGN/SPUN TPAN/TPCN TPKN TPUN TPMR SEET*PER-PF SEET*PER-PM SEET*PER-PR

Page Seite B229 B230 B231 B232 B232 B221 B221 B221



SEET-LH RCKT-DM RCKT-DR RCKT-ER RCKT-NM RDKW

Page Seite B221 B216 B216 B216 B216 B217

B

Milling Tools
Fräser

Inserts - square shoulder milling · WSP - Eckfräsen



APKT-PF APKT-PM APKT-PR APKT-LH APKT-APF APKT-APM APKT-ALH

Page	B205	B205	B205	B205	B205	B205	B205
Seite							



APMT**PDR APMT**PDER ANGX*PNR-GM ANGX*PNR-LH

Page	B206	B206	B204	B204
Seite				

Inserts for profile milling · WSP - Formfräsen



ZDET ZPNT SPMT ROHX XPHT-GM ZOHX-GF ZOHX-GM

Page	B234	B235	B228	B218	B233	B235	B235
Seite							

Inserts - side and face milling WSP - Seiten- und Stirnunfräsen



XSEQ MPHT QC**L

Page	B234	B210	B214 / 215
Seite			

Inserts - high feed milling WSP - Hochvorschubfräsen



SDMT SDMT-DM SDMT-PM WPGT WPGT-PM

Page	B218	B219	B219	B233	B233
Seite					

Inserts - T-slot milling WSP - T-Nuten - Fräsen



MPHT

Page	B210
Seite	

Inserts - helical milling WSP - Zirkularfräsen



APKT-PM/KM SPMT-PM/KM

Page	B207	B228
Seite		

Inserts - chamfer milling WSP - Fasenfräsen



SPMT SPMT-KT SPMT-HT

Page	B228
Seite	

Inserts - face milling - square shoulder milling WSP - Planfräsen - Eckfräsen









CNE-A CNE-B

Page	B207	B207
Seite		

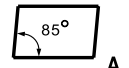
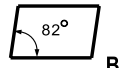
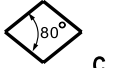

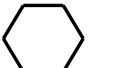
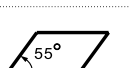
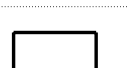
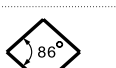
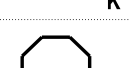
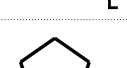

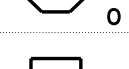
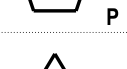

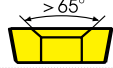
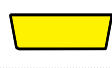
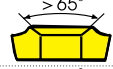

Milling - Fräsen

Indexable Milling Tools - Wendepplattenfräser

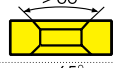
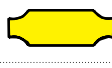
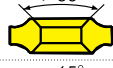
Indexable milling inserts code key · Wendepplattenfräser ISO Kode

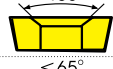
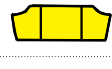
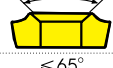







Insert Code · WSP Code		
 A	 B	 C
 D	 E	 H
 K	 L	 M
 O	 P	 R
 S	 T	 V
 W	Others Ander Z	

Insert · WSP

Metric System · Metrisches System							
Code	Hole Loch	Chipbreaker Spanbrecher	Section Form	Code	Hole Loch	Chipbreaker Spanbrecher	Section Form
B	✓	-		N	-	-	
H	✓	Single-side Einseitig		R	-	Single-side Einseitig	
C	✓	-		F	-	Double-side Doppelseitig	
J	✓	Double-side Doppelseitig		A	✓	-	
W	✓	-		M	✓	Single-side Einseitig	
T	✓	Single-side Einseitig		G	✓	Double-side Doppelseitig	
Q	✓	-		X	---	---	Special Spezial
U	✓	Double-side Doppelseitig					

Chipbreaker and clamping system
Spanbrecher und Klemmsystem

S P K N

Clearance angle of main cutting edge Freiwinkel der Hauptschneid			
Code	Clearance angle Freiwinkel	Code	Clearance angle Freiwinkel
A	 3°	B	 5°
C	 7°	D	 15°
E	 20°	F	 25°
G	 30°	N	 0°
P	 11°	O	Other clearance angle Andere Freiwinkel

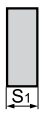
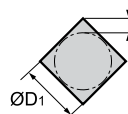
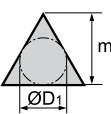
Tolerance · Toleranz												
												
		S_1		$\varnothing D_1$		$\varnothing D_1$						
Code	Nose height Tolerance Toleranzhöhe (mm)	M	Inscribed circle $\varnothing D_1$ Tolerance Toleranzinnenkreis $\varnothing D_1$ (mm)	Thickness Tolerance Toleranz Dicke (mm)	S	(Reference) details of M-class tolerance (identified by shape and size) (Referenz) Detail Toleranz M-Klasse (definiert durch Form und Größe) ● Nose height tolerance(mm) / Toleranz M						
						Inscribed circle Innenkreis	Regular Dreieckig	Square Viereckig	Diamond with 80° Raute mit 80°	Diamond with 55° Raute mit 55°	Diamond with 35° Raute mit 35°	Round Rund
A	±0.005		±0.025	±0.025		6.35	±0.08	±0.08	±0.08	±0.11	±0.16	---
F	±0.005		±0.013	±0.025		9.525	±0.08	±0.08	±0.08	±0.11	±0.16	---
C	±0.013		±0.025	±0.025		12.7	±0.13	±0.13	±0.13	±0.15	---	---
H	±0.013		±0.013	±0.025		15.875	±0.15	±0.15	±0.15	±0.18	---	---
E	±0.025		±0.025	±0.025		19.05	±0.15	±0.15	±0.15	±0.18	---	---
G	±0.025		±0.025	±0.13		25.4	---	±0.18	---	---	---	---
J	±0.005		±0.05 - ±0.13	±0.025		● Tolerance of Inscribed Circle $\varnothing D_1$ (mm) / Toleranzinnenkreis $\varnothing D_1$						
K	±0.013		±0.05 - ±0.13	±0.025		Inscribed circle Innenkreis	Regular Dreieckig	Square Viereckig	Diamond with 80° Raute mit 80°	Diamond with 55° Raute mit 55°	Diamond with 35° Raute mit 35°	Round Rund
L	±0.025		±0.05 - ±0.13	±0.025		6.35	±0.05	±0.05	±0.05	±0.05	±0.05	---
M	±0.08 - ±0.18		±0.05 - ±0.13	±0.13		9.525	±0.05	±0.05	±0.05	±0.05	±0.05	±0.05
N	±0.08 - ±0.18		±0.05 - ±0.13	±0.025		12.7	±0.08	±0.08	±0.08	±0.08	---	±0.58
U	±0.13 - ±0.38		±0.08 - ±0.25	±0.13		15.875	±0.10	±0.10	±0.10	±0.10	---	±0.10
						19.05	±0.10	±0.10	±0.10	±0.10	---	±0.10
						25.4	---	±0.13	---	---	---	±0.13

Diameter of IC Durchmesser von IC	Insert / WSP						
	C	D	R	S	T	V	W
3.97					06		
5.0			05				
5.56					09		
6.0			06				
6.35	06	07			11	11	
8.0			08				
9.525	09	11	09	09	16	16	06
10.0			10				
12.0			12				
12.7	12	15	12	12	22	22	08
15.875	16		15	15	27		
16.0		19	16				
19.05	19		19	19	33		
20.0			20				
25.0	25	25	25				
25.4			25	25			
31.75			31				
32			32				

Length of cutting edge · Schneidkantenlänge







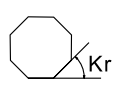
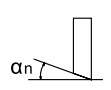

Code	Insert thickness (mm) Plattendicke
00	0.79
T0	0.99
01	1.59
T1	1.98
02	2.38
T2	2.58
03	3.18
T3	3.97
04	4.76
T4	4.96
05	5.96
T5	5.95
06	6.35
T6	6.75
07	7.94
09	9.52
T9	9.72
11	11.11
12	12.70

Insert thickness · WSP Dicke

12 04 ED T21K R-DM

Angel · Winkel			
			
A	45°	A	3°
D	60°	B	5°
E	75°	C	7°
F	85°	D	15°
P	90°	E	20°
Z	Others Andere	F	25°
		G	30°
		N	0°
		P	11°
		Z	Others Andere

Chamfer · Fase (mm)			
F			
		0-5°	0-0.10
E		1-10°	1-0.15
		2-15°	2-0.20
T		3-20°	3-0.25
		4-25°	4-0.30
S		5-30°	5-0.35
		6-40°	6-0.40
		7-45°	7-0.45
			
			No mark

Chipbreaker code
Spanbrecher

Cutting direction Schnitttrichtung	
R	Right hand Rechts
L	Left hand Links
N	Neutral Neutral

Milling - Fräsen

Indexable Milling - Fräswendeplatten

AN**

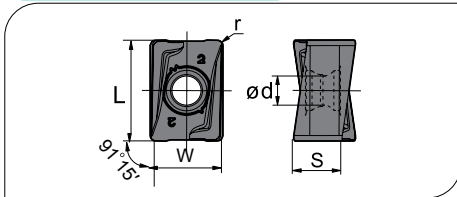

Workpiece Material Werkstoffe	Ideal Machining Condition Gute Bearbeitungsbedingungen			Normal Machining Condition Normale Bearbeitungsbedingungen			Unfavorable Machining Condition Ungünstige Bearbeitungsbedingungen								
	P	M	K	N	S	P	M	K	N	S	P	M	K	N	S
P Steel Stahl	●	●	●	●	●	●	●	●	●	●	●	●	●	●	●
M Stainless Steel Rostfreier Stahl	●	●	●	●	●	●	●	●	●	●	●	●	●	●	●
K Cast iron Gusseisen	●	●	●	●	●	●	●	●	●	●	●	●	●	●	●
N Non-ferrous material Nichtmetalle	●	●	●	●	●	●	●	●	●	●	●	●	●	●	●
S Heat-resistant steel Wärmebeständiger Stahl	●	●	●	●	●	●	●	●	●	●	●	●	●	●	●

Insert shape Plattenform	Type Typ	Dimension (mm) Abmessungen					CVD Coating CVD Beschicht.						PVD Coating PVD Beschicht.					Cermets Cermet	Carbide uncoat. unbe. Hartmetall										
		L	W	S	Ø d	r	YBC302	YBC301	YBC401	YBM253	YBM251	YBM351	YBD152	YBD252	YBG102	YB9320	YBG205			YBG202	YBG212	YBG302	YBG152	YBG252	YNG151	YNG151C	YC30S	YD101	YD201
	ANGX110504PNR-GM	11.85	8.4	5.7	3.5	0.8				●		●					●	●											
	ANGX110508PNR-GM	11.85	8.4	5.7	3.5	0.4	○			●		●	●				●	●											
	ANGX150608PNR-GM	15.43	11.0	7.3	4.4	0.8	○			●		●	●				●	●											
	ANGX150616PNR-GM	15.43	11.0	7.3	4.4	1.6				●		●						●											
	ANGX150620PNR-GM	15.43	11.0	7.3	4.4	2.0				●			●					●											

AN**

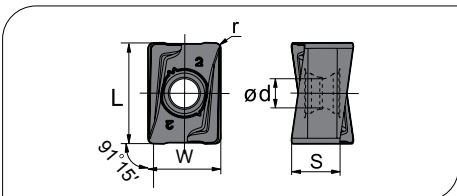

Workpiece Material Werkstoffe	Ideal Machining Condition Gute Bearbeitungsbedingungen			Normal Machining Condition Normale Bearbeitungsbedingungen			Unfavorable Machining Condition Ungünstige Bearbeitungsbedingungen								
	P	M	K	N	S	P	M	K	N	S	P	M	K	N	S
P Steel Stahl	●	●	●	●	●	●	●	●	●	●	●	●	●	●	●
M Stainless Steel Rostfreier Stahl	●	●	●	●	●	●	●	●	●	●	●	●	●	●	●
K Cast iron Gusseisen	●	●	●	●	●	●	●	●	●	●	●	●	●	●	●
N Non-ferrous material Nichtmetalle	●	●	●	●	●	●	●	●	●	●	●	●	●	●	●
S Heat-resistant steel Wärmebeständiger Stahl	●	●	●	●	●	●	●	●	●	●	●	●	●	●	●

Insert shape Plattenform	Type Typ	Dimension (mm) Abmessungen					CVD Coating CVD Beschicht.						PVD Coating PVD Beschicht.					Cermets Cermet	Carbide uncoat. unbe. Hartmetall										
		L	W	S	Ø d	r	YBC302	YBC301	YBC401	YBM253	YBM251	YBM351	YBD152	YBD252	YBG102	YB9320	YBG205			YBG202	YBG212	YBG302	YBG152	YBG252	YNG151	YNG151C	YC30S	YD101	YD201
	ANGX110504PNR-LH	11.85	8.4	5.7	3.5	0.8																							
	ANGX150608PNR-LH	15.43	11.0	7.3	4.4	0.8																							

● Ex Stock / ab Lager ○ On demand / auf Anfrage

AP**

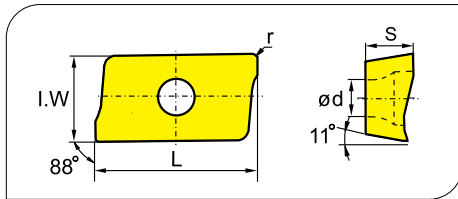

Workpiece Material Werkstoffe	Ideal Machining Condition Gute Bearbeitungsbedingungen		Normal Machining Condition Normale Bearbeitungsbedingungen		Unfavorable Machining Condition Ungünstige Bearbeitungsbedingungen	
	P	M	K	N	S	
P Steel Stahl	●	●	●	●	●	●
M Stainless Steel Rostfreier Stahl	●	●	●	●	●	●
K Cast iron Gusseisen	●	●	●	●	●	●
N Non-ferrite material Ne Metalle						
S Heat-resistant steel Warmfester Stahl						

Insert shape Plattenform	Type Typ	Dimensions (mm) Abmessungen					CVD Coating CVD Beschicht.						PVD Coating PVD Beschicht.						Cermet Cermet	Carbide uncoat. unbe. Hartmetall								
		L	I.W	S	d	r	YBC302	YBC301	YBC401	YBM253	YBM251	YBM351	YBD152	YBD252	YBG102	YB9320	YBG205	YBG202			YBG212	YBG302	YBG152	YBG252	YNG151	YNG151C	YC30S	YD101
	APKT11T304-PF	12.24	6.5	3.6	2.8	0.4		○			●																	
	APKT11T308-PF	12.24	6.5	3.6	2.8	0.8					●																	
	APKT11T312-PF	12.24	6.5	3.6	2.8	1.2													○									
	APKT11T316-PF	12.24	6.5	3.6	2.8	1.6															●							
	APKT160408-PF	17.877	9.33	5.76	4.4	0.8		●			●	●									●							
	APKT160430-PF	17.877	9.33	5.76	4.4	3.0																						
	APKT11T304-PM	12.24	6.5	3.6	2.8	0.4	●	●	●		●	●			●													
	APKT11T308-PM	12.24	6.5	3.6	2.8	0.8	●	●		●	●	●	●	●	●					●								
	APKT11T312-PM	12.24	6.5	3.6	2.8	1.2					●				●					●								
	APKT11T316-PM	12.24	6.5	3.6	2.8	1.6						●									●							
	APKT160408-PM	17.877	9.33	5.76	4.4	0.8		●	●	●	●	●	●	●	●						●							
	APKT160416-PM	17.877	9.33	5.76	4.4	3.0		●													●							
	APKT11T304-PR	12.24	6.5	3.6	2.8	0.4																						
	APKT11T308-PR	12.24	6.5	3.6	2.8	0.8																						
	APKT11T312-PR	12.24	6.5	3.6	2.8	1.2																						
	APKT11T316-PR	12.24	6.5	3.6	2.8	1.6																						
	APKT160408-PR	17.877	9.33	5.76	4.4	0.8																						
	APKT11T304-LH	12.24	6.5	3.6	2.8	0.4																					●	●
	APKT11T308-LH	12.24	6.5	3.6	2.8	0.8																					●	●
	APKT160408-LH	17.877	9.33	5.76	4.4	0.8																					●	●
	APKT11T304-APF	12.24	6.5	3.6	2.8	0.4																						
	APKT11T308-APF	12.24	6.5	3.6	2.8	0.8																						
	APKT160408-APF	17.877	9.33	5.76	4.4	0.8																						
	APKT11T304-APM	12.24	6.5	3.6	2.8	0.4																						
	APKT11T308-APM	12.24	6.5	3.6	2.8	0.8																						
	APKT11T312-APM	12.24	6.5	3.6	2.8	1.2																						
	APKT11T316-APM	12.24	6.5	3.6	2.8	1.6																						
	APKT11T320-APM	12.24	6.5	3.6	2.8	2.0																						
	APKT160408-APM	17.877	9.33	5.76	4.4	0.8																						
	APKT160416-APM	17.877	9.33	5.76	4.4	1.6																						
	APKT160420-APM	17.877	9.33	5.76	4.4	2.0																						
	APKT160424-APM	17.877	9.33	5.76	4.4	2.4																						
	APKT160430-APM	17.877	9.33	5.76	4.4	3.0																						
	APKT11T304-ALH	12.24	6.5	3.6	2.8	0.4																					●	●
	APKT11T308-ALH	12.24	6.5	3.6	2.8	0.8																					●	●
	APKT160408-ALH	17.877	9.33	5.76	4.4	0.8																					●	●

Applicable tool B11-B18
Werkzeug

Tools code key B202-B203
WSP ISO

Grade selection guide B19-B23
Sortenauswahl

Technical data B236-B241
Technische Daten

Milling · Fräsen

Indexable Milling · Fräswendeplatten

AP**

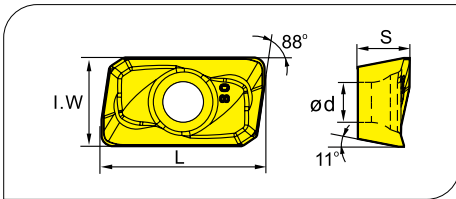

● Ideal Machining Condition / Gute Bearbeitungsbedingungen
 ● Normal Machining Condition / Normale Bearbeitungsbedingungen
 ● Unfavorable Machining Condition / Ungünstige Bearbeitungsbedingungen

Workpiece Material / Werkstoffe	P	M	K	N	S	YBC302	YBC301	YBC401	YBM253	YBM251	YBM351	YBD152	YBD252	YBG102	YB9320	YBG205	YBG202	YBG212	YBG302	YBG152	YBG252	YNG151	YNG151C	YC30S	YD101	YD201
P Steel / Stahl	●	●	●	●	●	●	●	●	●	●	●	●	●	●	●	●	●	●	●	●	●	●	●	●	●	●
M Stainless Steel / Rostfreier Stahl	●	●	●	●	●	●	●	●	●	●	●	●	●	●	●	●	●	●	●	●	●	●	●	●	●	●
K Cast iron / Gusseisen	●	●	●	●	●	●	●	●	●	●	●	●	●	●	●	●	●	●	●	●	●	●	●	●	●	●
N Non-ferrite material / Ne Metalle	●	●	●	●	●	●	●	●	●	●	●	●	●	●	●	●	●	●	●	●	●	●	●	●	●	●
S Heat-resistant steel / Warmfester Stahl	●	●	●	●	●	●	●	●	●	●	●	●	●	●	●	●	●	●	●	●	●	●	●	●	●	●

Insert WSP	Type Typ	Dimensions (mm) / Abmessungen					CVD Coating / CVD Beschicht.							PVD Coating / PVD Beschicht.					Cermets / Cermet	Carbide uncoat. / unbe. Hartmetall									
		L	I.W	S	d	r	YBC302	YBC301	YBC401	YBM253	YBM251	YBM351	YBD152	YBD252	YBG102	YB9320	YBG205	YBG202		YBG212	YBG302	YBG152	YBG252	YNG151	YNG151C	YC30S	YD101	YD201	
	APMT1135PDR	11.25	6.2	3.5	2.8	0.8				●							●	●		●									
	APMT160408PDER	17.25	9.25	4.76	4.4	0.8					●						●	●		●									
	APMT160432PDER	17.25	9.25	4.76	4.4	3.2					●																		

● Ex Stock / ab Lager ○ On demand / auf Anfrage

AP**

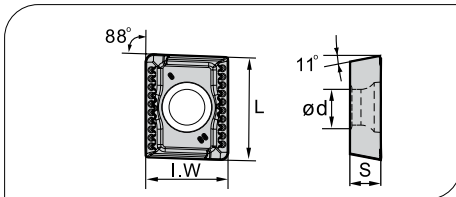

Workpiece Material Werkstoffe	Ideal Machining Condition Gute Bearbeitungsbedingungen			Normal Machining Condition Normale Bearbeitungsbedingungen			Unfavorable Machining Condition Ungünstige Bearbeitungsbedingungen								
	P	M	K	N	S	P	M	K	N	S	P	M	K	N	S
P Steel Stahl	●	●	●	●	●	●	●	●	●	●	●	●	●	●	●
M Stainless Steel Rostfreier Stahl	●	●	●	●	●	●	●	●	●	●	●	●	●	●	●
K Cast iron Gusseisen	●	●	●	●	●	●	●	●	●	●	●	●	●	●	●
N Non-ferrite material Ne Metalle	●	●	●	●	●	●	●	●	●	●	●	●	●	●	●
S Heat-resistant steel Warmfester Stahl	●	●	●	●	●	●	●	●	●	●	●	●	●	●	●

Insert WSP	Type Typ	Dimensions (mm) Abmessungen					CVD Coating CVD Beschicht.						PVD Coating PVD Beschicht.				Cermet Cermet	Carbide uncoat. unbe. Hartmetall									
		L	I.W	S	d	r	YBC302	YBC301	YBC401	YBM253	YBM251	YBM351	YBD152	YBD252	YBG102	YB9320			YBG205	YBG202	YBG212	YBG302	YBG152	YBG252	YNG151	YNG151C	YC30S
	APKT150412-PM	16.33	12.7	4.76	5.4	1.2				●										●							
	APKT150412-KM	16.33	12.7	4.76	5.4	1.2															●						

CN

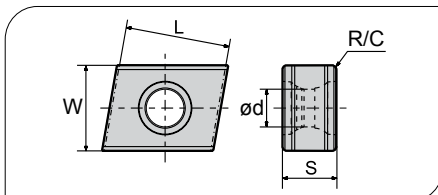

Workpiece Material Werkstoffe	Ideal Machining Condition Gute Bearbeitungsbedingungen			Normal Machining Condition Normale Bearbeitungsbedingungen			Unfavorable Machining Condition Ungünstige Bearbeitungsbedingungen								
	P	M	K	N	S	P	M	K	N	S	P	M	K	N	S
P Steel Stahl	●	●	●	●	●	●	●	●	●	●	●	●	●	●	●
M Stainless Steel Rostfreier Stahl	●	●	●	●	●	●	●	●	●	●	●	●	●	●	●
K Cast iron Gusseisen	●	●	●	●	●	●	●	●	●	●	●	●	●	●	●
N Non-ferrite material Ne Metalle	●	●	●	●	●	●	●	●	●	●	●	●	●	●	●
S Heat-resistant steel Warmfester Stahl	●	●	●	●	●	●	●	●	●	●	●	●	●	●	●

Insert WSP	Type Typ	Dimensions (mm) Abmessungen					CVD Coating CVD Beschicht.						PVD Coating PVD Beschicht.				Cermet Cermet	Carbide uncoat. unbe. Hartmetall									
		L	W	S	R/C	d	YBC302	YBC301	YBC401	YBM253	YBM251	YBM351	YBD152	YBD252	YBG102	YB9320			YBG205	YBG202	YBG212	YBG302	YBG152	YBG252	YNG151	YNG151C	YC30S
	CNE121006A	12.8	10.0	6.35	0.4	4.4				●																	
	CNE121006B	12.0	10.0	6.35	0.6	4.4				○		●															

Applicable tool B11-B18
Werkzeug

Tools code key B202-B203
WSP ISO

Grade selection guide B19-B23
Sortenauswahl

Technical data B236-B241
Technische Daten

Milling - Fräsen

Indexable Milling - Fräswendeplatten

HN**

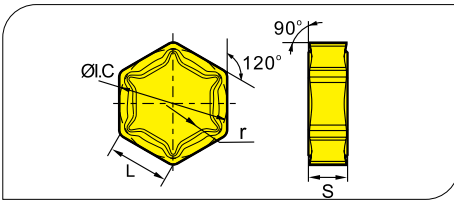

Workpiece Material Werkstoffe	Ideal Machining Condition Gute Bearbeitungsbedingungen			Normal Machining Condition Normale Bearbeitungsbedingungen			Unfavorable Machining Condition Ungünstige Bearbeitungsbedingungen		
	P	M	K	N	S				
P Steel Stahl	●	●	●	●	●	●	●	●	●
M Stainless Steel Rostfreier Stahl	●	●	●	●	●	●	●	●	●
K Cast iron Gusseisen						●	●		●
N Non-ferrite material Nf-Metalle									●
S Heat-resistant steel Warmfester Stahl						●	●	●	●

Insert WSP	Type Typ	Dimensions (mm) Abmessungen				CVD Coating CVD Beschicht.							PVD Coating PVD Beschicht.				Cermet Cemet	Carbide uncoat. unbe. Hartmetall									
		L	I.C	S	R	YBC302	YBC301	YBC401	YBM253	YBM251	YBM351	YBD152	YBD252	YBG102	YB9320	YBG205			YBG202	YBG212	YBG302	YBG152	YBG252	YNG151	YNG151C	YC30S	YD101
	HNEX090512-DF	9.16	15.875	5.56	1.2							○															
	HNEX090512-DM	9.16	15.875	5.56	1.2							○															
	HNEX090512-DR	9.16	15.875	5.56	1.2						●	●															
	HNGX090516-MR	9.16	15.875	5.56	1.6						●																
	HNGX090520-MR	9.16	15.875	5.56	2.0						●																
	HNGX090530-HDR	9.16	15.875	5.56	3.0						●																

● Ex Stock / ab Lager ○ On demand / auf Anfrage

LN**

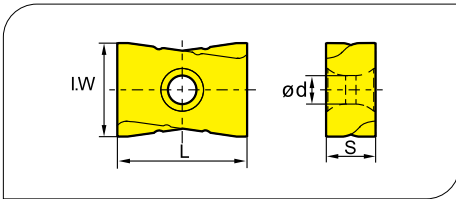

Workpiece Material Werkstoffe	Ideal Machining Condition Gute Bearbeitungsbedingungen			Normal Machining Condition Normale Bearbeitungsbedingungen			Unfavorable Machining Condition Ungünstige Bearbeitungsbedingungen		
	P	M	K	N	S				
P Steel Stahl	●	●	●	●	●	●	●	●	●
M Stainless Steel Rostfreier Stahl	●	●	●	●	●	●	●	●	●
K Cast iron Gusseisen						●	●	●	●
N Non-ferrous material Nichte Metalle									●
S Heat-resistant steel Wärmefester Stahl						●	●	●	●

Insert WSP	Type Typ	Dimensions (mm) Abmessungen				CVD Coating CVD Beschicht.						PVD Coating PVD Beschicht.						Cermets Cermets	Carbide uncoat. unbe. Hartmetall									
		L	I.W	S	d	YBC302	YBC301	YBC401	YBM253	YBM251	YBM351	YBD152	YBD252	YBG102	YBG320	YBG205	YBG202		YBG212	YBG302	YBG152	YBG252	YNG151	YNG151C	YC30S	YD101	YD201	
	LNKT120608-ZR	12.7	12	6.65	4.4	●			●						●													
	LNKT1506EN-ZR	15.875	14	6.35	4.6		●			●	●	●	●						●									
	LNKT2007DN-ZR	20	17	7.94	4.6					●	●	●							●									
	LNKT2510-ZR	25	18	9.525	5.5						●	●							●									

LN**

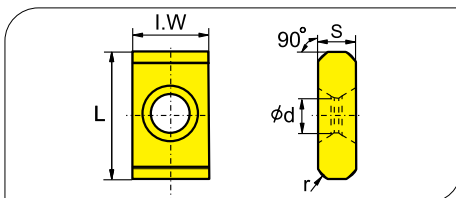

Workpiece Material Werkstoffe	Ideal Machining Condition Gute Bearbeitungsbedingungen			Normal Machining Condition Normale Bearbeitungsbedingungen			Unfavorable Machining Condition Ungünstige Bearbeitungsbedingungen		
	P	M	K	N	S				
P Steel Stahl	●	●	●	●	●	●	●	●	●
M Stainless Steel Rostfreier Stahl	●	●	●	●	●	●	●	●	●
K Cast iron Gusseisen						●	●	●	●
N Non-ferrous material Nichte Metalle									●
S Heat-resistant steel Wärmefester Stahl						●	●	●	●

Insert WSP	Type Typ	Dimensions (mm) Abmessungen					CVD Coating CVD Beschicht.						PVD Coating PVD Beschicht.						Cermets Cermets	Carbide uncoat. unbe. Hartmetall							
		L	I.W	S	d	r	YBC302	YBC301	YBC401	YBM253	YBM251	YBM351	YBD152	YBD252	YBG102	YBG320	YBG205	YBG202		YBG212	YBG302	YBG152	YBG252	YNG151	YNG151C	YC30S	YD101
	LNE32.534	15.875	9.525	4.76	4.4	1.6						●	●														
	LNE32.302	15.875	9.525	4.76	4.2	45 Fase								●													

Applicable tool
Werkzeug **B11-B18**

Tools code key
WSP ISO **B202-B203**

Grade selection guide
Sortenauswahl **B19-B23**

Technical data
Technische Daten **B236-B241**

OF**

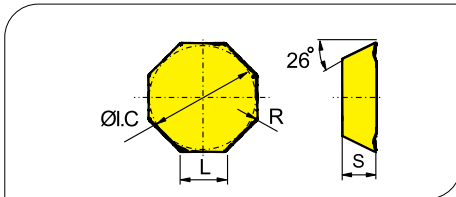

Workpiece Material Werkstoffe	Ideal Machining Condition Gute Bearbeitungsbedingungen			Normal Machining Condition Normale Bearbeitungsbedingungen			Unfavorable Machining Condition Ungünstige Bearbeitungsbedingungen								
	P	M	K	N	S	P	M	K	N	S	P	M	K	N	S
P Steel Stahl	●	●	●	●	●	●	●	●	●	●	●	●	●	●	●
M Stainless Steel Rostfreier Stahl	●	●	●	●	●	●	●	●	●	●	●	●	●	●	●
K Cast iron Gusseisen	●	●	●	●	●	●	●	●	●	●	●	●	●	●	●
N Non-ferrous material Nichtmetalle	●	●	●	●	●	●	●	●	●	●	●	●	●	●	●
S Heat-resistant steel Wärmebeständiger Stahl	●	●	●	●	●	●	●	●	●	●	●	●	●	●	●

Insert WSP	Type Typ	Dimensions (mm) Abmessungen				CVD Coating CVD Beschicht.				PVD Coating PVD Beschicht.				Cermets Cermet	Carbide uncoat. unbe. Hartmetall													
		L	I.C	S	R	YBC302	YBC301	YBC401	YBM253	YBM251	YBM351	YBD152	YBD252			YBG102	YBG320	YBG205	YBG202	YBG212	YBG302	YBG152	YBG252	YNG151	YNG151C	YC30S	YD101	YD201
	OFKR0704-DF	7.45	17.94	4.76	0.8					○							●											
	OFKR0704-DM	7.45	17.94	4.76	0.8	●	●		●	●		●					●		●									
	OFKR0704W-DM wiper	7.45	17.94	4.76	0.8	●						●					●											
	OFKR0704-LH	7.45	17.94	4.76	0.8																						●	

OF**

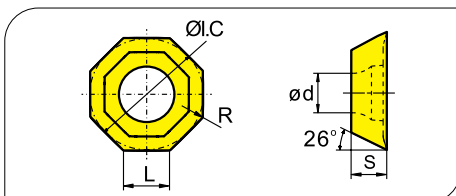

Workpiece Material Werkstoffe	Ideal Machining Condition Gute Bearbeitungsbedingungen			Normal Machining Condition Normale Bearbeitungsbedingungen			Unfavorable Machining Condition Ungünstige Bearbeitungsbedingungen								
	P	M	K	N	S	P	M	K	N	S	P	M	K	N	S
P Steel Stahl	●	●	●	●	●	●	●	●	●	●	●	●	●	●	●
M Stainless Steel Rostfreier Stahl	●	●	●	●	●	●	●	●	●	●	●	●	●	●	●
K Cast iron Gusseisen	●	●	●	●	●	●	●	●	●	●	●	●	●	●	●
N Non-ferrous material Nichtmetalle	●	●	●	●	●	●	●	●	●	●	●	●	●	●	●
S Heat-resistant steel Wärmebeständiger Stahl	●	●	●	●	●	●	●	●	●	●	●	●	●	●	●

Insert WSP	Type Typ	Dimensions (mm) Abmessungen					CVD Coating CVD Beschicht.				PVD Coating PVD Beschicht.				Cermets Cermet	Carbide uncoat. unbe. Hartmetall												
		L	I.C	S	d	R	YBC302	YBC301	YBC401	YBM253	YBM251	YBM351	YBD152	YBD252			YBG102	YBG320	YBG205	YBG202	YBG212	YBG302	YBG152	YBG252	YNG151	YNG151C	YC30S	YD101
	OFKT05T3-DF	5.26	12.7	3.97	4.4	0.5										●			●									
	OFKT05T3-DM	5.26	12.7	3.97	4.4	0.5					●		●			●			●		●							
	OFKT05T3-LH	5.26	12.7	3.97	4.4	0.5																				●		

Applicable tool B11-B18
Werkzeug

Tools code key B202-B203
WSP ISO

Grade selection guide B19-B23
Sortenauswahl

Technical data B236-B241
Technische Daten

Milling · Fräsen

Indexable Milling · Fräswendeplatten

ON**

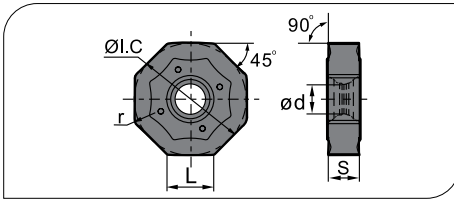

Workpiece Material Werkstoffe	Ideal Machining Condition Gute Bearbeitungsbedingungen			Normal Machining Condition Normale Bearbeitungsbedingungen			Unfavorable Machining Condition Ungünstige Bearbeitungsbedingungen		
	P	M	K	N	S				
P Steel Stahl	●	●	●	●	●	●	●	●	●
M Stainless Steel Rostfreier Stahl	●	●	●	●	●	●	●	●	●
K Cast iron Gusseisen						●	●	●	●
N Non-ferrite material Ne Metalle									●
S Heat-resistant steel Warmfester Stahl						●	●	●	●

Insert WSP	Type Typ	Dimensions (mm) Abmessungen					CVD Coating CVD Beschicht.						PVD Coating PVD Beschicht.					Cermet Cemet	Carbide uncoat. unbe. Hartmetall									
		L	ØI.C	S	ød	r	YBC302	YBC301	YBC401	YBM253	YBM251	YBM351	YBD152	YBD252	YBG102	YB9320	YBG205			YBG202	YBG212	YBG302	YBG152	YBG252	YNG151	YNG151C	YC30S	YD101
	ONHU060408-PF	6.58	15.875	4.76	4.4	0.83	●		●			●																
	ONHU08T508-PF	8.37	20.2	5.77	5.3	0.83	●		●			●																
	ONHU060408-PM	6.58	15.875	4.76	4.4	0.83	●		●		●	●																
	ONHU08T508-PM	8.37	20.2	5.79	5.3	0.83	●		●		●	●																
	ONHU08T624R-GM	6.38	20.2	6.3	2.4	0.8				●		●				●												
	ONHU08T508-W	6.9	20.5	6.00	5.3	0.80									○													

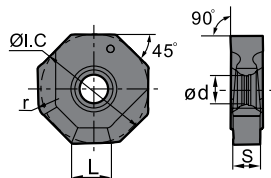

● Ex Stock / ab Lager ○ On demand / auf Anfrage

PN**

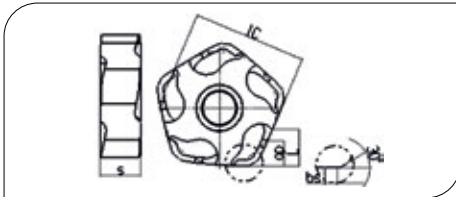

Workpiece Material Werkstoffe	Ideal Machining Condition Gute Bearbeitungsbedingungen			Normal Machining Condition Normale Bearbeitungsbedingungen			Unfavorable Machining Condition Ungünstige Bearbeitungsbedingungen		
	P	M	K	N	S				
P Steel Stahl	●	●	●	●	●	●	●	●	●
M Stainless Steel Rostfreier Stahl	●	●	●	●	●	●	●	●	●
K Cast iron Gusseisen	●	●	●	●	●	●	●	●	●
N Non-ferrite material Ne Metalle	●	●	●	●	●	●	●	●	●
S Heat-resistant steel Warmfester Stahl	●	●	●	●	●	●	●	●	●

Insert WSP	Type Typ	Dimension (mm) Abmessung						CVD Coating CVD Beschicht.				PVD Coating PVD Beschicht.				Cermet	Carbide uncoat.											
		L	ØI.C	S	ød	bs	ap	YBC302	YBC301	YBC401	YBM253	YBM251	YBM351	YBD152	YBD252	YBG102	YB9320	YBG205	YBG202	YBG212	YBG302	YBG152	YBG252	YNG151	YNG151C	YC30S	YD101	YD201
	PNEG110512R-CF	5.4	15.875	5.56	4.64	1.6	5																					
	PNEG110512L-CF	5.4	15.875	5.56	4.64	1.6	5																					
	PNEG110512R-CM	5.4	15.875	5.56	4.64	1.6	5																					
	PNEG110512L-CM	5.4	15.875	5.56	4.64	1.6	5																					
	PNEG110512R-CR	5.4	15.875	5.56	4.64	1.6	5																					
	PNEG110512L-CR	5.4	15.875	5.56	4.64	1.6	5																					

PN**

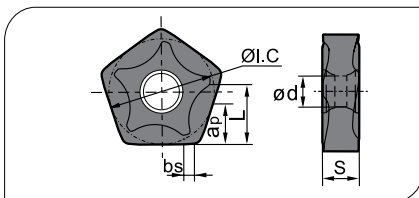

Workpiece Material Werkstoffe	Ideal Machining Condition Gute Bearbeitungsbedingungen			Normal Machining Condition Normale Bearbeitungsbedingungen			Unfavorable Machining Condition Ungünstige Bearbeitungsbedingungen		
	P	M	K	N	S				
P Steel Stahl	●	●	●	●	●	●	●	●	●
M Stainless Steel Rostfreier Stahl	●	●	●	●	●	●	●	●	●
K Cast iron Gusseisen	●	●	●	●	●	●	●	●	●
N Non-ferrite material Ne Metalle	●	●	●	●	●	●	●	●	●
S Heat-resistant steel Warmfester Stahl	●	●	●	●	●	●	●	●	●

Insert WSP	Insert Typ	Dimension (mm) Abmessung						CVD Coating CVD Beschicht.				PVD Coating PVD Beschicht.				Cermet	Carbide uncoat.											
		L	ØI.C	S	ød	bs	apmax	YBC302	YBC301	YBC401	YBM253	YBM251	YBM351	YBD152	YBD252	YBG102	YB9320	YBG205	YBG202	YBG212	YBG302	YBG152	YBG252	YNG151	YNG151C	YC30S	YD101	YD201
	PNEG110512R-PF	7.5	15.875	5.56	4.64	1.4	7.5	●			○																	
	PNEG110512L-PF	7.5	15.875	5.56	4.64	1.4	7.5	○																				
	PNEG110512R-PM	7.5	15.875	5.56	4.64	1.4	7.5	●			●																	
	PNEG110512L-PM	7.5	15.875	5.56	4.64	1.4	7.5	○			○																	
	PNEG110512R-PR	7.5	15.875	5.56	4.64	1.4	7.5	○			●																	
	PNEG110512L-PR	7.5	15.875	5.56	4.64	1.4	7.5	○			○																	

Applicable tool B11-B18
Werkzeug

Tools code key B202-B203
WSP ISO

Grade selection guide B19-B23
Sortenauswahl

Technical data B236-B241
Technische Daten

Milling · Fräsen

Indexable Milling · Fräswendeplatten

QC**L

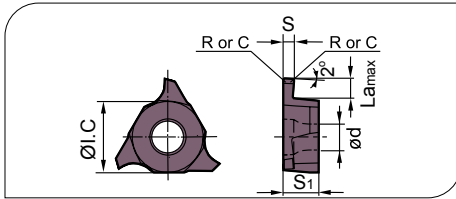

Workpiece Material Werkstoffe	Ideal Machining Condition Gute Bearbeitungsbedingungen	Normal Machining Condition Normale Bearbeitungsbedingungen	Unfavorable Machining Condition Ungünstige Bearbeitungsbedingungen
P Steel Stahl	●	●	●
M Stainless Steel Rostfreier Stahl	●	●	●
K Cast iron Gusseisen	●	●	●
N Non-ferrite material Ne Metalle	●	●	●
S Heat-resistant steel Warmfester Stahl	●	●	●

Insert WSP	Type Typ	Dimensions (mm) Abmessungen						CVD Coating CVD Beschicht.						PVD Coating PVD Beschicht.				Cermet Cermet	Carbide uncoat. unbe. Hartmetall										
		S±0.025	La _{max}	R/C	ØI.C	S ₁	ød	YBC302	YBC301	YBC401	YBM253	YBM251	YBM351	YBD152	YBD252	YBG102	YB9320			YBG205	YBG202	YBG212	YBG302	YBG152	YBG252	YNG151	YNG151C	YC30S	YD101
	QC16L110-R01	1.10	2.00	R0.1	9.525	3.18	4.4										●	●											
	QC16L125-R02	1.25	2.00	R0.2	9.525	3.18	4.4										●												
	QC16L145-R02	1.45	2.00	R0.2	9.525	3.18	4.4										●												
	QC16L150-R02	1.50	2.00	R0.2	9.525	3.18	4.4										●												
	QC16L175-R02	1.75	2.00	R0.2	9.525	3.18	4.4										●												
	QC16L185-R02	1.85	2.50	R0.2	9.525	3.18	4.4										●												
	QC16L200-R02	2.00	2.50	R0.2	9.525	3.18	4.4										●												
	QC16L250-R02	2.50	2.50	R0.2	9.525	3.18	4.4										●												
	QC16L300-R02	3.00	3.00	R0.2	9.525	3.18	4.4										●												

● Ex Stock / ab Lager ○ On demand / auf Anfrage

QC**L

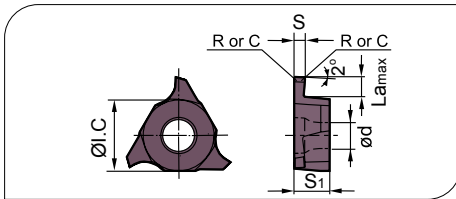

Workpiece Material Werkstoffe	Ideal Machining Condition Gute Bearbeitungsbedingungen			Normal Machining Condition Normale Bearbeitungsbedingungen			Unfavorable Machining Condition Ungünstige Bearbeitungsbedingungen								
	P	M	K	N	S	P	M	K	N	S	P	M	K	N	S
P Steel Stahl	●	●	●	●	●	●	●	●	●	●	●	●	●	●	●
M Stainless Steel Rostfreier Stahl	●	●	●	●	●	●	●	●	●	●	●	●	●	●	●
K Cast iron Gusseisen	●	●	●	●	●	●	●	●	●	●	●	●	●	●	●
N Non-ferrous material Nichtmetalle	●	●	●	●	●	●	●	●	●	●	●	●	●	●	●
S Heat-resistant steel Wärmebeständiger Stahl	●	●	●	●	●	●	●	●	●	●	●	●	●	●	●

Insert WSP	Type Typ	Dimensions (mm) Abmessungen						CVD Coating CVD Beschicht.						PVD Coating PVD Beschicht.				Cermet Cermet	Carbide uncoat. unbe. Hartmetall									
		S±0.025	La _{max}	R/C	ØI.C	S ₁	ød	YBC302	YBC301	YBC401	YBM253	YBM251	YBM351	YBD152	YBD252	YBG102	YB9320			YBG205	YBG202	YBG212	YBG302	YBG152	YBG252	YNG151	YNG151C	YC30S
	QC22L125-R02	1.25	2.00	R0.2	12.70	4.76	5.5										●	○										
	QC22L145-R02	1.45	2.00	R0.2	12.70	4.76	5.5										●	○										
	QC22L150-R02	1.50	3.50	R0.2	12.70	4.76	5.5										●											
	QC22L175-R02	1.75	3.50	R0.2	12.70	4.76	5.5										●	○										
	QC22L185-R02	1.85	3.50	R0.2	12.70	4.76	5.5										●	○										
	QC22L200-R02	2.00	3.50	R0.2	12.70	4.76	5.5										●											
	QC22L230-R02	2.30	3.50	R0.2	12.70	4.76	5.5										○											
	QC22L250-R03	2.50	4.00	R0.3	12.70	4.76	5.5										●											
	QC22L265-R03	2.65	4.00	R0.3	12.70	4.76	5.5										●											
	QC22L280-R03	2.80	4.00	R0.3	12.70	4.76	5.5										●											
	QC22L300-R03	3.00	4.00	R0.3	12.70	4.76	5.5										●											
	QC22L320-R03	3.20	4.00	R0.3	12.70	4.76	5.5										●											
	QC22L330-R03	3.30	4.00	R0.3	12.70	4.76	5.5										●	○										
	QC22L350-R03	3.50	5.00	R0.3	12.70	4.76	5.5										●											
	QC22L400-R04	4.00	5.00	R0.4	12.70	4.76	5.5										●											
	QC22L430-R04	4.30	5.00	R0.4	12.70	4.76	5.5										●	●										
	QC22L450-R04	4.50	5.00	R0.4	12.70	4.76	5.5										○	○										
	QC22L480-R04	4.80	5.00	R0.4	12.70	5.06	5.5										○	○										

Applicable tool
Werkzeug **B11-B18**

Tools code key
WSP ISO **B202-B203**

Grade selection guide
Sortenauswahl **B19-B23**

Technical data
Technische Daten **B236-B241**

Milling · Fräsen

Indexable Milling · Fräswendeplatten

RC**

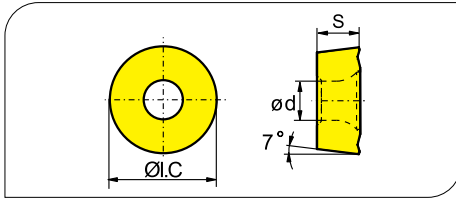

Workpiece Material Werkstoffe	Ideal Machining Condition Gute Bearbeitungsbedingungen			Normal Machining Condition Normale Bearbeitungsbedingungen			Unfavorable Machining Condition Ungünstige Bearbeitungsbedingungen		
	P	M	K	P	M	K	P	M	K
P Steel Stahl	●	●	●	●	●	●	●	●	●
M Stainless Steel Rostfreier Stahl	●	●	●	●	●	●	●	●	●
K Cast iron Gusseisen	●	●	●	●	●	●	●	●	●
N Non-ferrous material Nichte Metalle	●	●	●	●	●	●	●	●	●
S Heat-resistant steel Warmfester Stahl	●	●	●	●	●	●	●	●	●

Insert shape WSP	Type Typ	Dimension (mm) Abmessung			CVD Coating CVD Beschicht.						PVD Coating PVD Beschicht.						Cermets	Carbide uncoat.							
		I.C.	S	d	YBC302	YBC301	YBC401	YBM253	YBM251	YBM351	YBD152	YBD252	YBG102	YB9320	YBG205	YBG202	YBG212	YBG302	YBG152	YBG252	YNG151	YNG151C	YC30S	YD101	YD201
	RCKT10T3MO-DM	10.0	3.97	4.4	●	●									●		●								
	RCKT1204MO-DM	12.0	4.76	4.0	●	●		●	●	●					●		●								
	RCKT1606MO-DM	16.0	6.35	5.56	●	●		●							●		●								
	RCKT2006MO-DM	20.0	6.35	6.55	●	●		●																	
	RCKT1204MO-DR	12.0	4.76	4.0	●	●		●	●						●	●									
	RCKT1606MO-DR	16.0	6.35	5.56	●	●		●		●				●		●									
	RCKT2006MO-DR	20.0	6.35	6.55	●	●		●		●					●		●								
	RCKT1204MO-ER	12.0	4.76	4.0				●																	
	RCKT1606MO-ER	16.0	6.35	5.56				●																	
	RCKT2006MO-ER	20.0	6.35	6.55				●																	
	RCKT1204MO-NM	12.0	4.76	4.0					●							●									
	RCKT1606MO-NM	16.0	6.35	5.56												●									

● Ex Stock / ab Lager ○ On demand / auf Anfrage

RD**

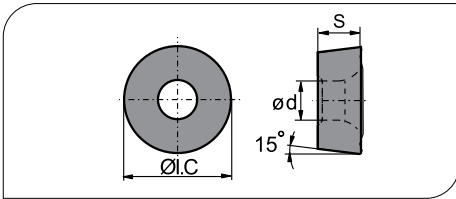

● Ideal Machining Condition / Gute Bearbeitungsbedingungen
● Normal Machining Condition / Normale Bearbeitungsbedingungen
● Unfavorable Machining Condition / Ungünstige Bearbeitungsbedingungen

Workpiece Material / Werkstoffe	P	M	K	N	S
Steel / Stahl	●	●	●	●	●
Stainless Steel / Rostfreier Stahl	●	●	●	●	●
Cast iron / Gusseisen	●	●	●	●	●
Non-ferrous material / Ne Metalle	●	●	●	●	●
Heat-resistant steel / Warmfester Stahl	●	●	●	●	●

Insert shape / Plattenform	Type / Typ	Dimension (mm) / Abmessung			CVD Coating / CVD Beschicht.				PVD Coating / PVD Beschicht.				Cermets / Cermet	Carbide uncoat. / unbe. Hartmetall												
		I.C.	S	d	YBC302	YBC301	YBC401	YBM253	YBM251	YBM351	YBD152	YBD252			YBG102	YB9320	YBG205	YBG202	YBG212	YBG302	YBG152	YBG252	YNG151	YNG151C	YC30S	YD101
	RDKW0702MO-1	7.0	2.38	2.7						●																
	RDKW0702MO-2	7.0	2.38	2.7																						
	RDKW1003MO-1	10.0	3.18	3.9																						
	RDKW1003MO-2	10.0	3.18	3.9																						
	RDKW1003MO-3	10.0	3.18	3.9																						
	RDKW12T3MO-1	12.0	3.97	3.9																						
	RDKW12T3MO-2	12.0	3.97	3.9																						
	RDKW12T3MO-3	12.0	3.97	3.9																						
	RDKW1604MO-1	16.0	4.76	5.2																						
	RDKW1604MO-2	16.0	4.76	5.2																						
RDKW1604MO-3	16.0	4.76	5.2																							

-1 normale Fase/ standard chamfer -2 kleine Fase/ small chamfer -3 große Fase/ large chamfer

RD**

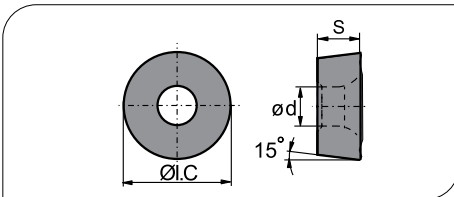

● Ideal Machining Condition / Gute Bearbeitungsbedingungen
● Normal Machining Condition / Normale Bearbeitungsbedingungen
● Unfavorable Machining Condition / Ungünstige Bearbeitungsbedingungen

Workpiece Material / Werkstoffe	P	M	K	N	S
Steel / Stahl	●	●	●	●	●
Stainless Steel / Rostfreier Stahl	●	●	●	●	●
Cast iron / Gusseisen	●	●	●	●	●
Non-ferrous material / Ne Metalle	●	●	●	●	●
Heat-resistant steel / Warmfester Stahl	●	●	●	●	●

Insert shape / Plattenform	Type / Typ	Dimension (mm) / Abmessung			CVD Coating / CVD Beschicht.				PVD Coating / PVD Beschicht.				Cermets / Cermet	Carbide uncoat. / unbe. Hartmetall												
		I.C.	S	d	YBC302	YBC301	YBC401	YBM253	YBM251	YBM351	YBD152	YBD252			YBG102	YB9320	YBG205	YBG202	YBG212	YBG302	YBG152	YBG252	YNG151	YNG151C	YC30S	YD101
	RDKW0803MO	8.0	3.18	3.4																						
	RDKW10T3MO	10.0	3.97	4.4																						
	RDKW1204MO	12.0	4.76	4.4																						
	RDKW1605MO	16.0	5.56	5.5																						
	RDKW2006MO	20.0	6.35	6.5																						
	RDKW2006MO-3	20.0	6.35	6.5																						

Applicable tool / Werkzeug **B11-B18**

Tools code key / WSP ISO **B202-B203**

Grade selection guide / Sortenauswahl **B19-B23**

Technical data / Technische Daten **B236-B241**

Milling - Fräsen

Indexable Milling - Fräswendeplatten

RO**

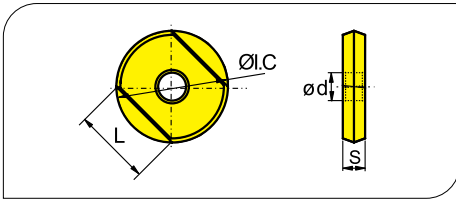

Workpiece Material Werkstoffe	Ideal Machining Condition Gute Bearbeitungsbedingungen			Normal Machining Condition Normale Bearbeitungsbedingungen			Unfavorable Machining Condition Ungünstige Bearbeitungsbedingungen			
	P	M	K	N	S	P	M	K	N	S
P Steel Stahl	●	●	●	●	●	●	●	●	●	●
M Stainless Steel Rostfreier Stahl		●	●	●	●	●	●	●	●	●
K Cast iron Gusseisen						●	●	●		●
N Non-ferrite material Ne Metalle									●	●
S Heat-resistant steel Warmfester Stahl					●	●	●	●	●	

Insert WSP	Type Typ	Dimensions (mm) Abmessungen				CVD Coating CVD Beschicht.				PVD Coating PVD Beschicht.				Cermet Cermet	Carbide uncoat. unbe. Hartmetall												
		I.C	L	S	d	YBC302	YBC301	YBC401	YBM253	YBM251	YBM351	YBD152	YBD252		YBG102	YB9320	YBG205	YBG202	YBG212	YBG302	YBG152	YBG252	YNG151	YNG151C	YC30S	YD101	YD201
	ROHX1203	12	8.5	3	4									○		●				●							
	ROHX1604	16	11.3	4	5												●				●						
	ROHX2005	20	14.1	5	5												●				●						

SD**

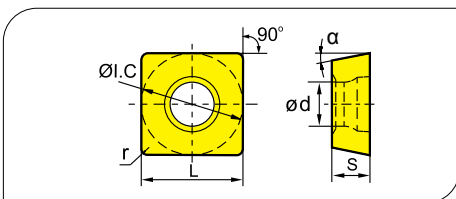

Workpiece Material Werkstoffe	Ideal Machining Condition Gute Bearbeitungsbedingungen			Normal Machining Condition Normale Bearbeitungsbedingungen			Unfavorable Machining Condition Ungünstige Bearbeitungsbedingungen			
	P	M	K	N	S	P	M	K	N	S
P Steel Stahl	●	●	●	●	●	●	●	●	●	●
M Stainless Steel Rostfreier Stahl		●	●	●	●	●	●	●	●	●
K Cast iron Gusseisen						●	●	●		●
N Non-ferrite material Ne Metalle									●	●
S Heat-resistant steel Warmfester Stahl					●	●	●	●	●	

Insert WSP	Type Typ	Dimensions (mm) Abmessungen						CVD Coating CVD Beschicht.						PVD Coating PVD Beschicht.						Cermet Cermet	Carbide uncoat. unbe. Hartmetall						
		r	L	I.C	S	d	α	YBC302	YBC301	YBC401	YBM253	YBM251	YBM351	YBD152	YBD252	YBG102	YB9320	YBG205	YBG202		YBG212	YBG302	YBG152	YBG252	YNG151	YNG151C	YC30S
	SDMT090308	0.8	9.525	9.525	3.18	4.4	15°					●	●														

● Ex Stock / ab Lager ○ On demand / auf Anfrage

SD**

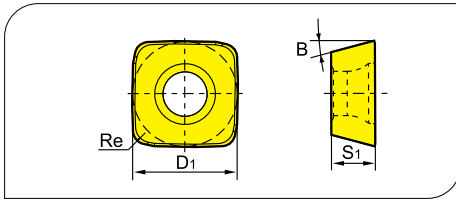

Workpiece Material Werkstoffe	Ideal Machining Condition Gute Bearbeitungsbedingungen			Normal Machining Condition Normale Bearbeitungsbedingungen			Unfavorable Machining Condition Ungünstige Bearbeitungsbedingungen		
	P	M	K	N	S				
P Steel Stahl	●	●	●	●	●	●	●	●	●
M Stainless Steel Rostfreier Stahl	●	●	●	●	●	●	●	●	●
K Cast iron Gusseisen						●	●	●	●
N Non-ferrous material Nichtmetalle									●
S Heat-resistant steel Wärmebeständiger Stahl						●	●	●	●

Insert WSP	Type Typ	Dimensions (mm) Abmessungen				CVD Coating CVD Beschicht.					PVD Coating PVD Beschicht.					Cermets Cermets	Carbide uncoat. unbe. Hartmetall									
		B	Re	S1	D1	YBC302	YBC301	YBC401	YBM253	YBM251	YBM351	YBD152	YBD252	YBG102	YB9320			YBG205	YBG202	YBG212	YBG302	YBG152	YBG252	YNG151	YNG151C	YC30S
	SDMT06T208-DM	15°	0.8	2.58	6.35					●																
	SDMT09T312-DM	15°	1.2	3.97	9.525	●				●	●															
	SDMT120412-DM	15°	1.2	4.76	12.7	●				●	●															
	SDMT150520-DM	15°	2.0	5.56	15.875													○								

SD**

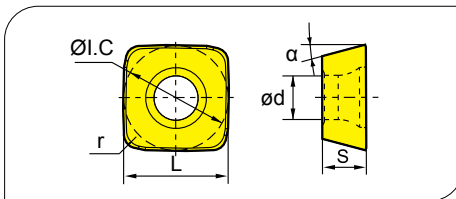

Workpiece Material Werkstoffe	Ideal Machining Condition Gute Bearbeitungsbedingungen			Normal Machining Condition Normale Bearbeitungsbedingungen			Unfavorable Machining Condition Ungünstige Bearbeitungsbedingungen		
	P	M	K	N	S				
P Steel Stahl	●	●	●	●	●	●	●	●	●
M Stainless Steel Rostfreier Stahl	●	●	●	●	●	●	●	●	●
K Cast iron Gusseisen						●	●	●	●
N Non-ferrous material Nichtmetalle									●
S Heat-resistant steel Wärmebeständiger Stahl						●	●	●	●

Insert WSP	Type Typ	Dimensions (mm) Abmessungen						CVD Coating CVD Beschicht.					PVD Coating PVD Beschicht.					Cermets Cermets	Carbide uncoat. unbe. Hartmetall								
		ØI.C	L	r	S	ød	α	YBC302	YBC301	YBC401	YBM253	YBM251	YBM351	YBD152	YBD252	YBG102	YB9320			YBG205	YBG202	YBG212	YBG302	YBG152	YBG252	YNG151	YNG151C
	SDMT06T208-PM	6.35	6.35	0.8	6.35	2.5	15°	●			●																
	SDMT09T312-PM	9.525	9.525	1.2	3.97	4.0	15°				●																
	SDMT120412-PM	12.7	12.7	2.0	4.76	4.4	15°				●																
	SDMT150520-PM	6.35	6.35	0.8	6.35	5.5	15°																				

Applicable tool
Werkzeug **B11-B18**

Tools code key
WSP ISO **B202-B203**

Grade selection guide
Sortenauswahl **B19-B23**

Technical data
Technische Daten **B236-B241**

Milling · Fräsen

Indexable Milling · Fräswendeplatten

SE**

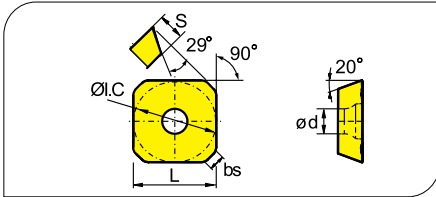

Workpiece Material Werkstoffe	Ideal Machining Condition Gute Bearbeitungsbedingungen			Normal Machining Condition Normale Bearbeitungsbedingungen			Unfavorable Machining Condition Ungünstige Bearbeitungsbedingungen		
	P	M	K	N	S				
P Steel Stahl	●	●	●	●	●	●	●	●	●
M Stainless Steel Rostfreier Stahl	●	●	●	●	●	●	●	●	●
K Cast iron Gusseisen	●	●	●	●	●	●	●	●	●
N Non-ferrite material Ne Metalle	●	●	●	●	●	●	●	●	●
S Heat-resistant steel Warmfester Stahl	●	●	●	●	●	●	●	●	●

Insert WSP	Type Typ	Dimensions (mm) Abmessungen						CVD Coating CVD Beschicht.						PVD Coating PVD Beschicht.						Cermets Cermets		Carbide uncoat. unbe. Hartmetall						
		L	I.C	S	d	bs	R	YBC302	YBC301	YBC401	YBM253	YBM251	YBM351	YBD152	YBD252	YBG102	YB9320	YBG205	YBG202	YBG212	YBG302	YBG152	YBG252	YNG151	YNG151C	YC30S	YD101	YD201
	SEET12T3-DF	13.40	13.40	3.97	4.1	2.55		●	●			●	●						●	○			●	●				
	SEET12T3-CF	13.40	13.40	3.97	4.1	2.55							●		●													
	SEET12T3-EF	13.40	13.40	3.97	4.1	2.55													●		●							
	SEET12T3-DM	13.40	13.40	3.97	4.1	2.55		●	●	●	●	●				●				●								
	SEET18T6-DM	13.90	18.00	6.10	5.5	2.29		●		●																		
	SEET12T3-CM	13.40	13.40	3.97	4.1	2.55							●		●													
	SEET12T3-EM	13.40	13.40	3.97	4.1	2.55						●	●						●		●							
	SEET12T3-DR	13.40	13.40	3.97	4.1	2.55			●	●			●		●					○		○						
	SEET12T3-CR	13.40	13.40	3.97	4.1	2.55								●	●													
	SEET12T3-LH	13.40	13.40	3.97	4.1	2.55									○											●	●	
	SEET12T3-W	17.82	13.40	3.97	4.1	9.46	500					○	●					●					●	○				

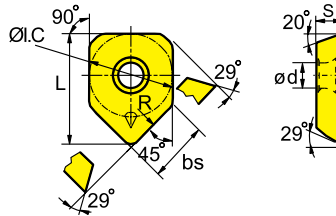

● Ex Stock / ab Lager ○ On demand / auf Anfrage

SE**

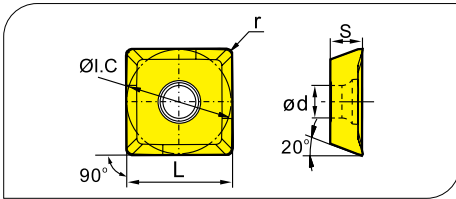

Workpiece Material Werkstoffe	Ideal Machining Condition Gute Bearbeitungsbedingungen			Normal Machining Condition Normale Bearbeitungsbedingungen			Unfavorable Machining Condition Ungünstige Bearbeitungsbedingungen		
	P	M	K	P	M	K	P	M	K
P Steel Stahl	●	●	●	●	●	●	●	●	●
M Stainless Steel Rostfreier Stahl	●	●	●	●	●	●	●	●	●
K Cast iron Guss Eisen	●	●	●	●	●	●	●	●	●
N Non-ferrous material Ne Metalle	●	●	●	●	●	●	●	●	●
S Heat-resistant steel Wärmeester Stahl	●	●	●	●	●	●	●	●	●

Insert WSP	Type Typ	Dimensions (mm) Abmessungen					CVD Coating CVD Beschicht.						PVD Coating PVD Beschicht.				Cermet Cermet	Carbide uncoat. unbe. Hartmetall											
		L	I.C	S	d	r	YBC302	YBC301	YBC401	YBM253	YBM251	YBM351	YBD152	YBD252	YBG102	YB9320			YBG205	YBG202	YBG212	YBG302	YBG152	YBG252	YNG151	YNG151C	YC30S	YD101	YD201
	SEET09T308PER-PF	9.525	9.525	4.01	3.3	0.8																							
	SEET09T308PER-PM	9.525	9.525	4.01	3.3	0.8							●						●										
	SEET09T308PER-PR	9.525	9.525	4.01	3.3	0.8							●								●								
	SEET120308PER-PF	13.308	13.308	4.04	4.1	0.8	●	●					●								●								
	SEET120308PER-PM	13.308	13.308	4.04	4.1	0.8	●				●	●	●	●	●					●		●							
	SEET120308PER-PR	13.308	13.308	4.04	4.1	0.8	●				●	●	●	●	●	○				●		●							
	SEET120308-LH	13.308	13.308	4.04	4.1	0.8																							●

Applicable tool
Werkzeug **B11-B18**

Tools code key
WSP ISO **B202-B203**

Grade selection guide
Sortenauswahl **B19-B23**

Technical data
Technische Daten **B236-B241**

Milling · Fräsen

Indexable Milling · Fräswendeplatten

SE**

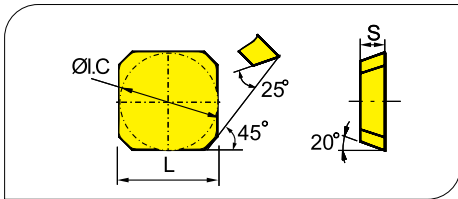

Workpiece Material Werkstoffe	Ideal Machining Condition Gute Bearbeitungsbedingungen			Normal Machining Condition Normale Bearbeitungsbedingungen			Unfavorable Machining Condition Ungünstige Bearbeitungsbedingungen			
	P	M	K	N	S					
P Steel Stahl	●	●	●	●	●	●	●	●	●	●
M Stainless Steel Rostfreier Stahl	●	●	●	●	●	●	●	●	●	●
K Cast iron Gusseisen						●	●	●	●	●
N Non-ferrite material Ne Metalle										●
S Heat-resistant steel Warmfester Stahl						●	●	●	●	●

Insert WSP	Type Typ	Dimensions (mm) Abmessungen			CVD Coating CVD Beschicht.						PVD Coating PVD Beschicht.					Cermet Cermet	Carbide uncoat. unbe. Hartmetall									
		L	I.C	S	YBC302	YBC301	YBC401	YBM253	YBM251	YBM351	YBD152	YBD252	YBG102	YB9320	YBG205			YBG202	YBG212	YBG302	YBG152	YBG252	YNG151	YNG151C	YC30S	YD101
	SEEN1203AFTN	12.7	12.7	3.18																	●					
	SEKN1203AFFN	12.7	12.7	3.18																						
	SEKN1203AFN	12.7	12.7	3.18	●																					
	SEKN1203AFTN	12.7	12.7	3.18	●		●	●								●						●	●	●	●	●
	SEKN1203AFS13N	12.7	12.7	3.18	○																					
	SEKN1204AFN	12.7	12.7	4.76																						
	SEKN1204AFTN	12.7	12.7	4.76	●																			●	●	
	SEKN1204AFS13N	12.7	12.7	4.76	○																					
	SEKN1504AFN	15.875	15.875	4.76	○																					
	SEKN1504AFTN	15.875	15.875	4.76	●	●		●	●															○		
	SEKN1504AFZN	15.875	15.875	4.76																						
	SEKN1204AZ	15.875	15.875	4.76	●	○																				
	SEKN1504AZ	15.875	15.875	4.76	●																					○

SE**

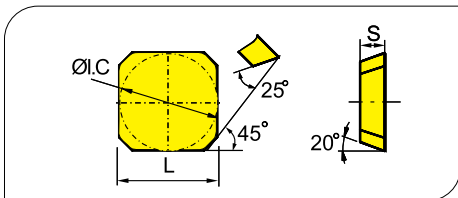

Workpiece Material Werkstoffe	Ideal Machining Condition Gute Bearbeitungsbedingungen			Normal Machining Condition Normale Bearbeitungsbedingungen			Unfavorable Machining Condition Ungünstige Bearbeitungsbedingungen			
	P	M	K	N	S					
P Steel Stahl	●	●	●	●	●	●	●	●	●	●
M Stainless Steel Rostfreier Stahl	●	●	●	●	●	●	●	●	●	●
K Cast iron Gusseisen						●	●	●	●	●
N Non-ferrite material Ne Metalle										●
S Heat-resistant steel Warmfester Stahl						●	●	●	●	●

Insert WSP	Type Typ	Dimensions (mm) Abmessungen			CVD Coating CVD Beschicht.						PVD Coating PVD Beschicht.					Cermet Cermet	Carbide uncoat. unbe. Hartmetall								
		L	I.C	S	YBC302	YBC301	YBC401	YBM253	YBM251	YBM351	YBD152	YBD252	YBG102	YB9320	YBG205			YBG202	YBG212	YBG302	YBG152	YBG252	YNG151	YNG151C	YC30S
	SEKR1203AFN	12.7	12.7	3.18	●																				
	SEKR1504AFN	15.875	15.875	4.76																				○	

● Ex Stock / ab Lager ○ On demand / auf Anfrage

SN**

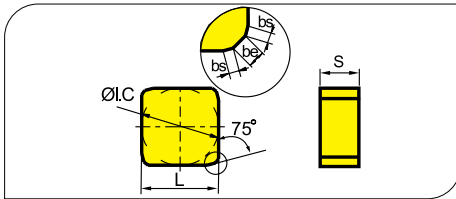

Workpiece Material Werkstoffe	Ideal Machining Condition Gute Bearbeitungsbedingungen			Normal Machining Condition Normale Bearbeitungsbedingungen			Unfavorable Machining Condition Ungünstige Bearbeitungsbedingungen		
	P	M	K	N	S				
P Steel Stahl	●	●	●	●	●	●	●	●	●
M Stainless Steel Rostfreier Stahl	●	●	●	●	●	●	●	●	●
K Cast iron Gusseisen						●	●	●	●
N Non-ferrous material Nichte Metalle									●
S Heat-resistant steel Wärmefester Stahl						●	●	●	●

Insert WSP	Type Typ	Dimensions (mm) Abmessungen					CVD Coating CVD Beschicht.					PVD Coating PVD Beschicht.					Cermet Cermet	Carbide uncoat. unbe. Hartmetall									
		L	I.C	S	be	bs	YBC302	YBC301	YBC401	YBM253	YBM251	YBM351	YBD152	YBD252	YBG102	YB9320			YBG205	YBG202	YBG212	YBG302	YBG152	YBG252	YNG151	YNG151C	YC30S
	SNKN1204ENN	12.7	12.7	4.76	0.9	1.5	●					●	●													●	●
	SNKN1504ENN	15.875	15.875	4.76	0.9	1.5	●					●														●	○
	SNKN1904ENN	19.05	19.05	4.76	1.0	1.5																					

SN**

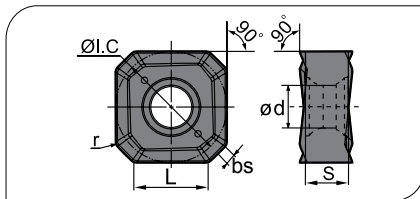

Workpiece Material Werkstoffe	Ideal Machining Condition Gute Bearbeitungsbedingungen			Normal Machining Condition Normale Bearbeitungsbedingungen			Unfavorable Machining Condition Ungünstige Bearbeitungsbedingungen		
	P	M	K	N	S				
P Steel Stahl	●	●	●	●	●	●	●	●	●
M Stainless Steel Rostfreier Stahl	●	●	●	●	●	●	●	●	●
K Cast iron Gusseisen						●	●	●	●
N Non-ferrous material Nichte Metalle									●
S Heat-resistant steel Wärmefester Stahl						●	●	●	●

Insert WSP	Type Typ	Dimensions (mm) Abmessungen						CVD Coating CVD Beschicht.					PVD Coating PVD Beschicht.					Cermet Cermet	Carbide uncoat. unbe. Hartmetall								
		L	ØI.C	S	bs	ød	r	YBC302	YBC301	YBC401	YBM253	YBM251	YBM351	YBD152	YBD252	YBG102	YB9320			YBG205	YBG202	YBG212	YBG302	YBG152	YBG252	YNG151	YNG151C
	SNEG1205ANR-GM	7.6	12.0	4.76	1.05	4.6	0.8	●			●	●															
	SNEG1506ANR-GM	7.6	15.0	5.54	1.30	5.5	0.9	●			●	●															
	SNEG1506ANR-GR	9.4	15.0	5.54	1.30	5.5	0.9	●			●	●															
	SNEG1907ANR-GR	12.1	19.0	7.0	1.67	7.2	1.0	●			●	●		●	●												
	SNEG1506ANR-E	9.4	15.0	5.6	1.30	5.5	0.9																				
	SNEG1205ANR-W	12	12	4.76	0.6	4.6	0.8																				

Applicable tool B11-B18
Werkzeug

Tools code key B202-B203
WSP ISO

Grade selection guide B19-B23
Sortenauswahl

Technical data B236-B241
Technische Daten

Milling · Fräsen

Indexable Milling · Fräswendeplatten

SP*N

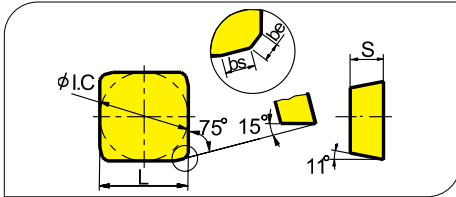

Workpiece Material Werkstoffe	Ideal Machining Condition Gute Bearbeitungsbedingungen			Normal Machining Condition Normale Bearbeitungsbedingungen			Unfavorable Machining Condition Ungünstige Bearbeitungsbedingungen								
	P	M	K	N	S	P	M	K	N	S	P	M	K	N	S
P Steel Stahl	●	●	●	●	●	●	●	●	●	●	●	●	●	●	●
M Stainless Steel Rostfreier Stahl	●	●	●	●	●	●	●	●	●	●	●	●	●	●	●
K Cast iron Gusseisen	●	●	●	●	●	●	●	●	●	●	●	●	●	●	●
N Non-ferrite material Nf Metalle	●	●	●	●	●	●	●	●	●	●	●	●	●	●	●
S Heat-resistant steel Warmfester Stahl	●	●	●	●	●	●	●	●	●	●	●	●	●	●	●

Insert WSP	Type Typ	Dimensions (mm) Abmessungen					CVD Coating CVD Beschicht.						PVD Coating PVD Beschicht.					Cermet Cermet	Carbide uncoat. unbe. Hartmetall								
		L	I.C	S	be	bs	YBC302	YBC301	YBC401	YBM253	YBM251	YBM351	YBD152	YBD252	YBG102	YB9320	YBG205			YBG202	YBG212	YBG302	YBG152	YBG252	YNG151	YNG151C	YC30S
	SPAN1203EDEL	12.7	12.7	1.4	1	3.18	●																				
	SPAN1203EDER	12.7	12.7	1.4	1	3.18	●																				
	SPAN1203EDFL	12.7	12.7	1.4	1	3.18																				○	
	SPAN1203EDFR	12.7	12.7	1.4	1	3.18																				●	
	SPAN1203EDL	12.7	12.7	1.4	1	3.18																					○
	SPAN1203EDR	12.7	12.7	1.4	1	3.18																					○
	SPAN1504EDFR	15.875	15.875	1.4	1	4.76																					○
	SPAN1504EDFL	15.875	15.875	1.4	1	4.76																					○
	SPCN1203EDSKR	12.7	12.7	1.4	1	3.18	●																				
	SPCN1504EDSKR	15.875	15.875	1.4	1	4.76	●																				

● Ex Stock / ab Lager ○ On demand / auf Anfrage

SP*N

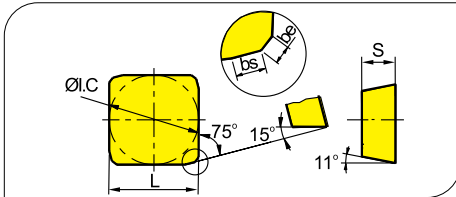

Workpiece Material Werkstoffe	Ideal Machining Condition Gute Bearbeitungsbedingungen			Normal Machining Condition Normale Bearbeitungsbedingungen			Unfavorable Machining Condition Ungünstige Bearbeitungsbedingungen		
	P	M	K	P	M	K	P	M	K
P Steel Stahl	●	●	●	●	●	●	●	●	●
M Stainless Steel Rostfreier Stahl	●	●	●	●	●	●	●	●	●
K Cast iron Gusseisen	●	●	●	●	●	●	●	●	●
N Non-ferrite material Ne Metalle	●	●	●	●	●	●	●	●	●
S Heat-resistant steel Warmfester Stahl	●	●	●	●	●	●	●	●	●

Insert WSP	Type Typ	Dimensions (mm) Abmessungen					CVD Coating CVD Beschicht.						PVD Coating PVD Beschicht.						Cermets Cermets	Carbide uncoat. unbe. Hartmetall								
		L	I.C	S	be	bs	YBC302	YBC301	YBC401	YBM253	YBM251	YBM351	YBD152	YBD252	YBG102	YB9320	YBG205	YBG202			YBG212	YBG302	YBG152	YBG252	YNG151	YNG151C	YC30S	YD101
	SPKN1203EDER	12.7	12.7	3.18	1	1.4																						
	SPKN1203EDEL	12.7	12.7	3.18	1	1.4																						
	SPKN1203EDFR	12.7	12.7	3.18	1	1.4	●							●													●	
	SPKN1203EDFL	12.7	12.7	3.18	1	1.4																					●	
	SPKN1203EDSKR	12.7	12.7	3.18	1	1.4	●	●					●						●	●						●		
	SPKN1203EDSKL	12.7	12.7	3.18	1	1.4	●												●		●					●		
	SPKN1203EDTKR	12.7	12.7	3.18	1	1.4	○					●									●					●		
	SPKN1203EDTKL	12.7	12.7	3.18	1	1.4																						
	SPKN1203EDS31PR	12.7	12.7	3.18	1	1.4													○									
	SPKN1203EDS31PL	12.7	12.7	3.18	1	1.4																						
	SPKN1203EDT31R	12.7	12.7	3.18	1	1.4																					●	
	SPKN1203EDT31L	12.7	12.7	3.18	1	1.4																						
	SPKN1204EDFL	12.7	12.7	4.76	1	1.4	●	●																		●		
	SPKN1204EDER	12.7	12.7	4.76	1	1.4																						
	SPKN1204EDFR	12.7	12.7	4.76	1	1.4																						
	SPKN1204EDSKR	12.7	12.7	4.76	1	1.4							●															
	SPKN1504EDER	15.875	15.875	4.76	1	1.4																						
	SPKN1504EDEL	15.875	15.875	4.76	1	1.4																						
	SPKN1504EDFR	15.875	15.875	4.76	1	1.4																					●	
	SPKN1504EDFL	15.875	15.875	4.76	1	1.4																					●	
	SPKN1504EDL	15.875	15.875	4.76	1	1.4																				●	●	
	SPKN1504EDSKR	15.875	15.875	4.76	1	1.4	●						●						●	●					●			
	SPKN1504EDSKL	15.875	15.875	4.76	1	1.4														●								
	SPKN1504EDTKR	15.875	15.875	4.76	1	1.4														●								
	SPKN1504EDTKL	15.875	15.875	4.76	1	1.4																						
	SPKN1504EDS32PR	15.875	15.875	4.76	1	1.4						○								●								
	SPKN1504EDS32PL	15.875	15.875	4.76	1	1.4																						
SPKN1504EDT32PR	15.875	15.875	4.76	1	1.4														●									
SPKN1504EDT32PL	15.875	15.875	4.76	1	1.4																							



Applicable tool B11-B18
Werkzeug

Tools code key B202-B203
WSP ISO

Grade selection guide B19-B23
Sortenauswahl

Technical data B236-B241
Technische Daten

Milling - Fräsen

Indexable Milling - Fräswendeplatten

SP*R

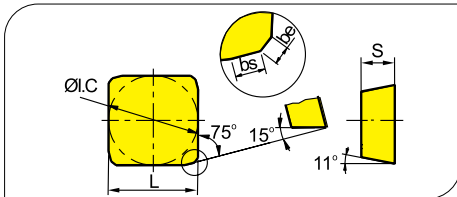

Workpiece Material Werkstoffe	Ideal Machining Condition Gute Bearbeitungsbedingungen			Normal Machining Condition Normale Bearbeitungsbedingungen			Unfavorable Machining Condition Ungünstige Bearbeitungsbedingungen		
	P	M	K	P	M	K	P	M	K
P Steel Stahl	●	●	●	●	●	●	●	●	●
M Stainless Steel Rostfreier Stahl	●	●	●	●	●	●	●	●	●
K Cast iron Gusseisen	●	●	●	●	●	●	●	●	●
N Non-ferrite material Ne Metalle	●	●	●	●	●	●	●	●	●
S Heat-resistant steel Warmfester Stahl	●	●	●	●	●	●	●	●	●

Insert WSP	Type Typ	Dimensions (mm) Abmessungen					CVD Coating CVD Beschicht.					PVD Coating PVD Beschicht.					Cermet Cermet	Carbide uncoat. unbe. Hartmetall									
		L	I.C	S	be	bs	YBC302	YBC301	YBC401	YBM253	YBM251	YBM351	YBD152	YBD252	YBG102	YB9320			YBG205	YBG202	YBG212	YBG302	YBG152	YBG252	YNG151	YNG151C	YC30S
	SPKR1203EDR-GM	12.7	12.7	3.18	1	1.4					●																
	SPKR1203EDL-GM	12.7	12.7	3.18	1	1.4					●																
	SPKR1504EDR-GM	15.875	15.875	4.76	1	1.4				●								●									
	SPKR1504EDL-GM	15.875	15.875	4.76	1	1.4				●								●									
	SPKR1203EDR	12.7	12.7	3.18	1	1.4	●																		●		
	SPKR1904EDFL	19.05	19.05	4.76	1	1.4																					
	SPKR1904EDFR	19.05	19.05	4.76	1	1.4																					

SP*W

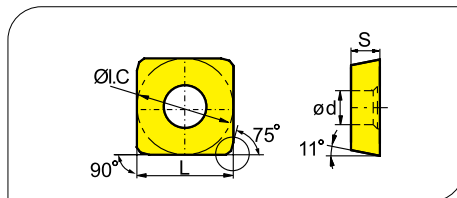

Workpiece Material Werkstoffe	Ideal Machining Condition Gute Bearbeitungsbedingungen			Normal Machining Condition Normale Bearbeitungsbedingungen			Unfavorable Machining Condition Ungünstige Bearbeitungsbedingungen		
	P	M	K	P	M	K	P	M	K
P Steel Stahl	●	●	●	●	●	●	●	●	●
M Stainless Steel Rostfreier Stahl	●	●	●	●	●	●	●	●	●
K Cast iron Gusseisen	●	●	●	●	●	●	●	●	●
N Non-ferrite material Ne Metalle	●	●	●	●	●	●	●	●	●
S Heat-resistant steel Warmfester Stahl	●	●	●	●	●	●	●	●	●

Insert WSP	Type Typ	Dimensions (mm) Abmessungen							CVD Coating CVD Beschicht.					PVD Coating PVD Beschicht.					Cermet Cermet	Carbide uncoat. unbe. Hartmetall								
		r	L	I.C	S	d	α	YBC302	YBC301	YBC401	YBM253	YBM251	YBM351	YBD152	YBD252	YBG102	YB9320	YBG205			YBG202	YBG212	YBG302	YBG152	YBG252	YNG151	YNG151C	YC30S
	SPKW1204EDFR	---	12.7	12.7	4.76	5.56	11°												●									
	SPKW1204EDSR	---	12.7	12.7	4.76	5.56	11°												●									

● Ex Stock / ab Lager ○ On demand / auf Anfrage

SP*X

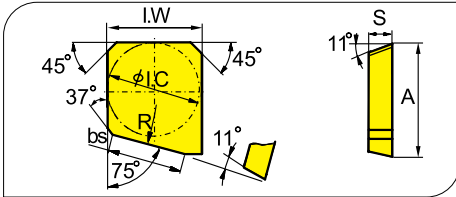

Workpiece Material Werkstoffe	Ideal Machining Condition Gute Bearbeitungsbedingungen			Normal Machining Condition Normale Bearbeitungsbedingungen			Unfavorable Machining Condition Ungünstige Bearbeitungsbedingungen								
	P	M	K	N	S	P	M	K	N	S	P	M	K	N	S
P Steel Stahl	●	●	●	●	●	●	●	●	●	●	●	●	●	●	●
M Stainless Steel Rostfreier Stahl	●	●	●	●	●	●	●	●	●	●	●	●	●	●	●
K Cast iron Guss Eisen						●	●	●	●	●	●	●	●	●	●
N Non-ferrite material Ne Metalle															●
S Heat-resistant steel Warmfester Stahl										●	●	●	●	●	●

Insert WSP	Type Typ	Dimensions (mm) Abmessungen						CVD Coating CVD Beschicht.					PVD Coating PVD Beschicht.					Cermet Cermet	Carbide uncoat. unbe. Hartmetall										
		A	I.C	I.W	S	bs	R	YBC302	YBC301	YBC401	YBM253	YBM251	YBM351	YBD152	YBD252	YBG102	YB9320		YBG205	YBG202	YBG212	YBG302	YBG152	YBG252	YNG151	YNG151C	YC30S	YD101	YD201
	SPEX1203EDL-1	15	12.7	12.7	3.18	10	500																						○
	SPEX1203EDR-1	15	12.7	12.7	3.18	10	500																						○
	SPEX1504EDL-1	18.2	15.875	15.875	4.76	10	500																						○
	SPEX1504EDR-1	18.2	15.875	15.875	4.76	10	500																						●

B

Milling Tools
Fräser

Applicable tool
Werkzeug **B11-B18**

Tools code key
WSP ISO **B202-B203**

Grade selection guide
Sortenauswahl **B19-B23**

Technical data
Technische Daten **B236-B241**

Milling - Fräsen

Indexable Milling - Fräswendeplatten

SP**

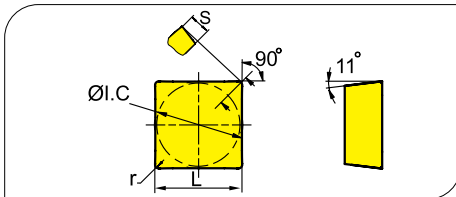

Workpiece Material Werkstoffe	Ideal Machining Condition Gute Bearbeitungsbedingungen			Normal Machining Condition Normale Bearbeitungsbedingungen			Unfavorable Machining Condition Ungünstige Bearbeitungsbedingungen			
	●	●	●	●	●	●	●	●	●	
P Steel Stahl	●	●	●	●	●	●	●	●	●	●
M Stainless Steel Rostfreier Stahl	●	●	●	●	●	●	●	●	●	●
K Cast iron Gusseisen	●	●	●	●	●	●	●	●	●	●
N Non-ferrite material Ne Metalle	●	●	●	●	●	●	●	●	●	●
S Heat-resistant steel Warmfester Stahl	●	●	●	●	●	●	●	●	●	●

Insert WSP	Type Typ	Dimensions (mm) Abmessungen				CVD Coating CVD Beschicht.						PVD Coating PVD Beschicht.				Cermet Cermet	Carbide uncoat. unbe. Hartmetall									
		L	I.C	s	r	YBC302	YBC301	YBC401	YBM253	YBM251	YBM351	YBD152	YBD252	YBG102	YB9320			YBG205	YBG202	YBG212	YBG302	YBG152	YBG252	YNG151	YNG151C	YC30S
	SPMR090304	9.525	9.525	3.18	0.4					●																
	SPMR09T304	9.525	9.525	3.97	0.4																					
	SPMR090308	9.525	9.525	3.18	0.8					●																
	SPMR120304	12.7	12.7	3.18	0.4					●																
	SPMR120308	12.7	12.7	3.18	0.8					●	●															
	SPMR120312	12.7	12.7	3.18	1.2						●															

SP**

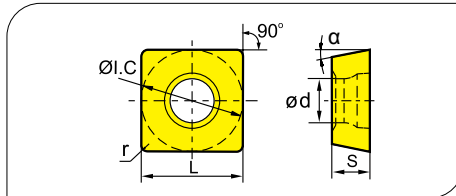

Workpiece Material Werkstoffe	Ideal Machining Condition Gute Bearbeitungsbedingungen			Normal Machining Condition Normale Bearbeitungsbedingungen			Unfavorable Machining Condition Ungünstige Bearbeitungsbedingungen			
	●	●	●	●	●	●	●	●	●	
P Steel Stahl	●	●	●	●	●	●	●	●	●	●
M Stainless Steel Rostfreier Stahl	●	●	●	●	●	●	●	●	●	●
K Cast iron Gusseisen	●	●	●	●	●	●	●	●	●	●
N Non-ferrite material Ne Metalle	●	●	●	●	●	●	●	●	●	●
S Heat-resistant steel Warmfester Stahl	●	●	●	●	●	●	●	●	●	●

Insert WSP	Type Typ	Dimensions (mm) Abmessungen						CVD Coating CVD Beschicht.						PVD Coating PVD Beschicht.				Cermet Cermet	Carbide uncoat. unbe. Hartmetall								
		r	L	I.C	S	d	α	YBC302	YBC301	YBC401	YBM253	YBM251	YBM351	YBD152	YBD252	YBG102	YB9320			YBG205	YBG202	YBG212	YBG302	YBG152	YBG252	YNG151	YNG151C
	SPMT060304-KT	0.4	6.35	6.35	3.18	2.8	11°		●																		
	SPMT060304	0.4	6.35	6.35	3.18	2.8	11°				●																
	SPMT09T308-HT	0.8	9.525	9.525	3.97	4.4	11°					●		●													
	SPMT09T308	0.8	9.525	9.525	3.97	4.4	11°		●	○																	
	SPMT120408	0.8	12.7	12.70	4.76	5.5	11°		●	●		●	●									●					
	SPMT120408-HT-1	0.8	12.7	12.70	4.76	5.5	11°															●					
	SPMT120408-PM	0.8	12.7	12.70	4.76	5.5	11°				●										●						
	SPMT120408-KM	0.8	12.7	12.70	4.76	5.5	11°															●					
	SPKT1204EDR	--	12.7	12.7	4.76	5.56	11°													●							

● Ex Stock / ab Lager ○ On demand / auf Anfrage

Milling - Fräsen

Indexable Milling - Fräswendeplatten

SP**

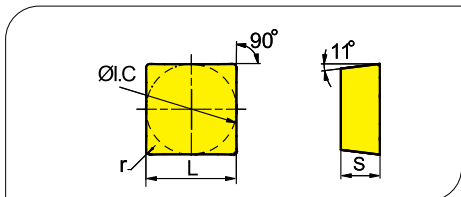

Workpiece Material Werkstoffe	Ideal Machining Condition Gute Bearbeitungsbedingungen			Normal Machining Condition Normale Bearbeitungsbedingungen			Unfavorable Machining Condition Ungünstige Bearbeitungsbedingungen		
	P	M	K	N	S				
P Steel Stahl	●	●	●	●	●	●	●	●	●
M Stainless Steel Rostfreier Stahl	●	●	●	●	●	●	●	●	●
K Cast iron Gusseisen	●	●	●	●	●	●	●	●	●
N Non-ferrite material Ne Metalle	●	●	●	●	●	●	●	●	●
S Heat-resistant steel Warmfester Stahl	●	●	●	●	●	●	●	●	●

Insert WSP	Type Typ	Dimensions (mm) Abmessungen				CVD Coating CVD Beschicht.						PVD Coating PVD Beschicht.					Cermet Cermet	Carbide uncoat. unbe. Hartmetall								
		L	I.C	s	r	YBC302	YBC301	YBC401	YBM253	YBM251	YBM351	YBD152	YBD252	YBG102	YB9320	YBG205	YBG202	YBG212	YBG302	YBG152	YBG252	YNG151	YNG151C	YC30S	YD101	YD201
	SPUN090304	9.525	9.525	3.18	0.4																			●		
	SPUN090308	9.525	9.525	3.18	0.8																			●		
	SPUN120304	12.7	12.7	3.18	0.4																			●		
	SPUN120308	12.7	12.7	3.18	0.8					●	●													●		●
	SPUN120312	12.7	12.7	3.18	1.2					●														●		
	SPUN150408	15.875	15.875	4.76	0.8																			●		●
	SPUN150412	15.875	15.875	4.76	1.2																			●		●
	SPUN190408	19.05	19.05	4.76	0.8																			●		
	SPUN190412	19.05	19.05	4.76	1.2																			●		
SPUN190416	19.05	19.05	4.76	1.6																			●			
	SPGN090304	9.525	9.525	3.18	0.4																		●			
	SPGN090308	9.525	9.525	3.18	0.8																		○			
	SPGN120304	12.7	12.7	3.18	0.4												○						●			
	SPGN120308	12.7	12.7	3.18	0.8												●						●			
	SPGN120404	12.7	12.7	4.76	0.4																					
	SPGN120408	12.7	12.7	4.76	0.8																					
	SPGN120412	12.7	12.7	4.76	1.2																					
	SPGN150404	15.875	15.875	4.76	0.4																					
	SPGN150408	15.875	15.875	4.76	0.8																			●		
	SPGN150412	15.875	15.875	4.76	1.2																			●		
	SPGN190408	19.05	19.05	4.76	0.8																			●		
SPGN190416	19.05	19.05	4.76	1.6																			●			

B
Milling Tools
Fräser

Applicable tool
Werkzeug **B11-B18**

Tools code key
WSP ISO **B202-B203**

Grade selection guide
Sortenauswahl **B19-B23**

Technical data
Technische Daten **B236-B241**

Milling - Fräsen

Indexable Milling - Fräsplatte

TP**

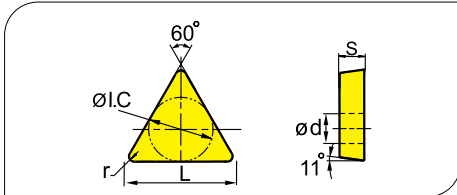

Workpiece Material Werkstoffe	P Steel Stahl	M Stainless Steel Rostfreier Stahl	K Cast iron Gusseisen	N Non-ferrous material Nichtmetalle	S Heat-resistant steel Wärmebeständiger Stahl	Ideal Machining Condition Gute Bearbeitungsbedingungen			Normal Machining Condition Normale Bearbeitungsbedingungen			Unfavorable Machining Condition Ungünstige Bearbeitungsbedingungen		
						1	2	3	1	2	3	1	2	3
P	●	●	●	●	●	●	●	●	●	●	●	●	●	●
M	●	●	●	●	●	●	●	●	●	●	●	●	●	●
K	●	●	●	●	●	●	●	●	●	●	●	●	●	●
N	●	●	●	●	●	●	●	●	●	●	●	●	●	●
S	●	●	●	●	●	●	●	●	●	●	●	●	●	●

Insert WSP	Type Typ	Dimensions (mm) Abmessungen						CVD Coating CVD Beschicht.						PVD Coating PVD Beschicht.						Cermets Cermet		Carbide uncoat. unbe. Hartmetall										
		L	I.C.	bs	be	an	S	YBC302	YBC301	YBC401	YBM253	YBM251	YBM351	YBD152	YBD252	YBG102	YB9320	YBG205	YBG202	YBG212	YBG302	YBG152	YBG252	YNG151	YNG151C	YC30S	YD101	YD201				
	TPCN1103PPS22PN	11	6.35	0.721	0.704	11°	3.175																						●			
	TPCN1603PPS42PN	16.5	9.525	1.197	1.235	11°	3.18																							●		
	TPCN2204PDFR	22	12.7	1.4	1.4	15°	4.76																								○	
	TPCN2204PDRSKR	22	12.7	1.4	1.4	15°	4.76		●																							●
	TPCN2204PPEN	22	12.7	1.4	1.4	11°	4.76		○																							
	TPAN1103PP22PN	11	6.35	0.7	0.7	11°	3.18		○											○											○	
	TPAN1603PPS42PN	16.5	9.525	1.2	1.2	11°	3.18																								●	
	TPAN2204PDER	22	12.7	1.4	1.4	15°	4.76																								○	
	TPAN2204PDFR	22	12.7	1.4	1.4	11°	4.76																								○	

● Ex Stock / ab Lager ○ On demand / auf Anfrage

TP**

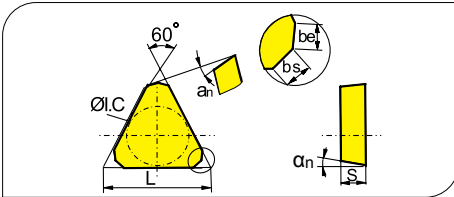

Workpiece Material Werkstoffe	Ideal Machining Condition Gute Bearbeitungsbedingungen			Normal Machining Condition Normale Bearbeitungsbedingungen			Unfavorable Machining Condition Ungünstige Bearbeitungsbedingungen		
	P	M	K	N	S				
P Steel Stahl	●	●	●	●	●	●	●	●	●
M Stainless Steel Rostfreier Stahl	●	●	●	●	●	●	●	●	●
K Cast iron Gusseisen						●	●		●
N Non-ferrous material Nichte Metalle									●
S Heat-resistant steel Wärmeester Stahl						●	●	●	●

Insert WSP	Type Typ	Dimensions (mm) Abmessungen						CVD Coating CVD Beschicht.						PVD Coating PVD Beschicht.						Cermets Cermets	Carbide uncoat. unbe. Hartmetall								
		L	I.C	S	be	bs	an	YBC302	YBC301	YBC401	YBM253	YBM251	YBM351	YBD152	YBD252	YBG102	YB9320	YBG205	YBG202			YBG212	YBG302	YBG152	YBG252	YNG151	YNG151C	YC30S	YD101
	TPKN1603PDRSKR	16.5	9.525	3.18	1.2	1	11°	●											●							●			
	TPKN1603PDSKL	16.5	9.525	3.18	1.2	1	11°																						
	TPKN1603PDTKR	16.5	9.525	3.18	1.2	1	11°									●												●	
	TPKN1603PPER	16.5	9.525	3.18	1.2	1	11°	●																			●		
	TPKN1603PPFR	16.5	9.525	3.18	1.2	1	11°												○									●	
	TPKN2204PDTKR	22	12.7	4.76	1.4	0.7	11°									●													
	TPKN2204PDFR	22	12.7	4.76	1.4	0.7	11°									●												●	
	TPKN2204PDFL	22	12.7	4.76	1.4	0.7	11°																					○	
	TPKN2204PDSKR	22	12.7	4.76	1.4	0.7	11°	●	●			●	●				●	●		●						●			
	TPKN2204PDL	22	12.7	4.76	1.4	0.7	11°	●																		●		●	
	TPKN2204PDTR	22	12.7	4.76	1.4	0.7	11°		○										○							●			
	TPKN2204PDS32PR	22	12.7	4.76	0.693	1.411	11°													●									
	TPKN2204PDSKL	22	12.7	4.76	1.419	0.712	11°	●																					
	TPKN2204PDR	22	12.7	4.76	1.4	0.7	11°													●									

Applicable tool
Werkzeug **B11-B18**

Tools code key
WSP ISO **B202-B203**

Grade selection guide
Sortenauswahl **B19-B23**

Technical data
Technische Daten **B236-B241**

Milling · Fräsen

Indexable Milling · Fräswendeleplatten

TP**

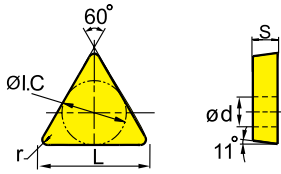

Workpiece Material Werkstoffe	Ideal Machining Condition Gute Bearbeitungsbedingungen			Normal Machining Condition Normale Bearbeitungsbedingungen			Unfavorable Machining Condition Ungünstige Bearbeitungsbedingungen		
	P	M	K	N	S				
P Steel Stahl	●	●	●	●	●	●	●	●	●
M Stainless Steel Rostfreier Stahl	●	●	●	●	●	●	●	●	●
K Cast iron Gusseisen				●	●	●	●	●	●
N Non-ferrite material Ne Metalle									●
S Heat-resistant steel Warmfester Stahl						●	●	●	●

Insert WSP	Type Typ	Dimensions (mm) Abmessungen				CVD Coating CVD Beschicht.				PVD Coating PVD Beschicht.				Cermet Cermet	Carbide uncoat. unbe. Hartmetall														
		L	I.C	s	r	YBC302	YBC301	YBC401	YBM253	YBM251	YBM351	YBD152	YBD252		YBG102	YB9320	YBG205	YBG202	YBG212	YBG302	YBG152	YBG252	YNG151	YNG151C	YC30S	YD101	YD201		
	TPUN110208	11	6.35	2.38	0.8																								
	TPUN110304	11	6.35	3.18	0.4				●																●				
	TPUN110308	11	6.35	3.18	0.8				●																●				
	TPUN160304	16.5	9.525	3.18	0.4				●																●				
	TPUN160308	16.5	9.525	3.18	0.8				●	○															●		●		
	TPUN160312	16.5	9.525	3.18	1.2				●																●		●		
	TPUN160408	16.5	9.525	4.76	0.8																								
	TPUN160412	16.5	9.525	4.76	1.2																								
	TPUN220404	22	12.7	4.76	0.4																					●			
	TPUN220408	22	12.7	4.76	0.8					●																●			
	TPUN220412	22	12.7	4.76	1.2						●															●		○	
	TPUN220416	22	12.7	4.76	1.6																							○	
	TPMR090204	9.6	5.56	2.38	0.4				●																				
	TPMR110304	11	6.35	3.18	0.4				●															●					
	TPMR110308	11	6.35	3.18	0.8				●															○					
	TPMR160304	16.5	9.525	3.18	0.4				●	○															○	●			
	TPMR160308	16.5	9.525	3.18	0.8				●	●															○	●			
	TPMR160312	16.5	9.525	3.18	1.2				○	●																			
	TPMR220412	22	12.7	4.76	1.2				●																				
	TPMR330916	33	19.05	9.52	1.6																								

● Ex Stock / ab Lager ○ On demand / auf Anfrage

WP**

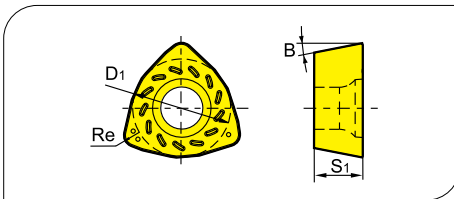

Workpiece Material Werkstoffe	Ideal Machining Condition Gute Bearbeitungsbedingungen			Normal Machining Condition Normale Bearbeitungsbedingungen			Unfavorable Machining Condition Ungünstige Bearbeitungsbedingungen		
	P	M	K	N	S				
P Steel Stahl	●	●	●	●	●	●	●	●	●
M Stainless Steel Rostfreier Stahl	●	●	●	●	●	●	●	●	●
K Cast iron Gusseisen	●	●	●	●	●	●	●	●	●
N Non-ferrous material Ne Metalle	●	●	●	●	●	●	●	●	●
S Heat-resistant steel Wärmfester Stahl	●	●	●	●	●	●	●	●	●

Insert WSP	Type Typ	Dimensions (mm) Abmessungen				CVD Coating CVD Beschicht.				PVD Coating PVD Beschicht.				Cermet Cermet	Carbide uncoat. unbe. Hartmetall													
		B	Re	S ₁	D ₁	YBC302	YBC301	YBC401	YBM253	YBM251	YBM351	YBD152	YBD252		YBG102	YB9320	YBG205	YBG202	YBG212	YBG302	YBG152	YBG252	YNG151	YNG151C	YC30S	YD101	YD201	
	WPGT050315ZSR	11°	1.5	3.5	7.94	●																						
	WPGT060415ZSR	11°	1.5	4.2	9.525	●																						
	WPGT080615ZSR	11°	1.5	6.35	12.85	●																						
	WPGT090725ZSR	11°	2.5	7	15																							
	WPGT050315ZSR-PM	11°	1.5	3.5	7.94																							
	WPGT060415ZSR-PM	11°	1.5	4.2	9.525	●																						
	WPGT080615ZSR-PM	11°	1.5	6.35	12.85	●																						
	WPGT090725ZSR-PM	11°	2.5	7	15																							

XP**

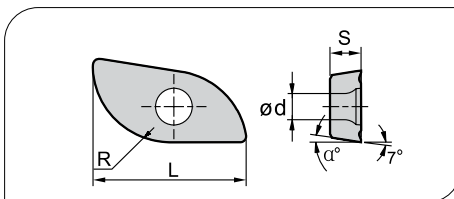

Workpiece Material Werkstoffe	Ideal Machining Condition Gute Bearbeitungsbedingungen			Normal Machining Condition Normale Bearbeitungsbedingungen			Unfavorable Machining Condition Ungünstige Bearbeitungsbedingungen		
	P	M	K	N	S				
P Steel Stahl	●	●	●	●	●	●	●	●	●
M Stainless Steel Rostfreier Stahl	●	●	●	●	●	●	●	●	●
K Cast iron Gusseisen	●	●	●	●	●	●	●	●	●
N Non-ferrous material Ne Metalle	●	●	●	●	●	●	●	●	●
S Heat-resistant steel Wärmfester Stahl	●	●	●	●	●	●	●	●	●

Insert WSP	Type Typ	Dimensions (mm) Abmessungen					CVD Coating CVD Beschicht.				PVD Coating PVD Beschicht.				Cermet Cermet	Carbide uncoat. unbe. Hartmetall												
		R	d	S	α°	L	YBC302	YBC301	YBC401	YBM253	YBM251	YBM351	YBD152	YBD252		YBG102	YB9320	YBG205	YBG202	YBG212	YBG302	YBG152	YBG252	YNG151	YNG151C	YC30S	YD101	YD201
	XPHT16R0803-GM	8	3.1	3.18	9	16																						
	XPHT20R10T3-GM	10	4.0	3.97	9	20																						
	XPHT25R1204-GM	12.5	4.7	4.76	9	25																						
	XPHT30R1506-GM	15	5.8	6.35	11	30																						
	XPHT32R1606-GM	16	5.8	6.35	9	32																						
	XPHT40R2007-GM	20	6.8	7.94	9	40																						
	XPHT50R2507-GM	25	9.2	7.94	9	50																						

Applicable tool B11-B18
Werkzeug

Tools code key B202-B203
WSP ISO

Grade selection guide B19-B23
Sortenauswahl

Technical data B236-B241
Technische Daten

Milling · Fräsen

Indexable Milling · Fräswendeplatten

XS**

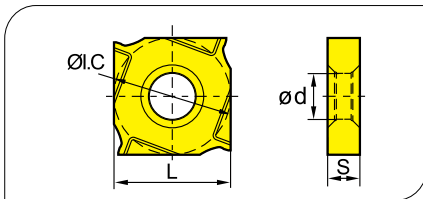

		● Ideal Machining Condition Gute Bearbeitungsbedingungen	● Normal Machining Condition Normale Bearbeitungsbedingungen	● Unfavorable Machining Condition Ungünstige Bearbeitungsbedingungen
Workpiece Material Werkstoffe	P Steel Stahl	●	●	●
	M Stainless Steel Rostfreier Stahl	●	●	●
	K Cast iron Gusseisen		●	●
	N Non-ferrous material Nichte Metalle			●
	S Heat-resistant steel Wärmefester Stahl		●	●

Insert WSP	Type Typ	Dimensions (mm) Abmessungen				CVD Coating CVD Beschicht.							PVD Coating PVD Beschicht.					Cermet Cermet	Carbide uncoat. unbe. Hartmetall							
		I.C	L	S	d	YBC302	YBC301	YBC401	YBM253	YBM251	YBM351	YBD152	YBD252	YBG102	YB9320	YBG205	YBG202			YBG212	YBG302	YBG152	YBG252	YNG151	YNG151C	YC30S
	XSEQ1202	12.7	12.7	2.3	5.0																					
	XSEQ1203	12.7	12.7	3.0	5.0	●			●											●						
	XSEQ12T3	12.7	12.7	3.5	5.0		●													●						○
	XSEQ1204	12.7	12.7	4.0	5.0																●					
	XSEQ12T4	12.7	12.7	4.5	5.0																●					

ZD**

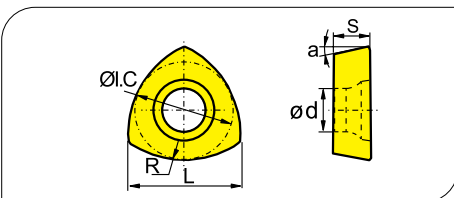

		● Ideal Machining Condition Gute Bearbeitungsbedingungen	● Normal Machining Condition Normale Bearbeitungsbedingungen	● Unfavorable Machining Condition Ungünstige Bearbeitungsbedingungen
Workpiece Material Werkstoffe	P Steel Stahl	●	●	●
	M Stainless Steel Rostfreier Stahl	●	●	●
	K Cast iron Gusseisen		●	●
	N Non-ferrous material Nichte Metalle			●
	S Heat-resistant steel Wärmefester Stahl		●	●

Insert WSP	Type Typ	Dimensions (mm) Abmessungen						CVD Coating CVD Beschicht.							PVD Coating PVD Beschicht.					Cermet Cermet	Carbide uncoat. unbe. Hartmetall							
		I.C	L	S	R	d	α	YBC302	YBC301	YBC401	YBM253	YBM251	YBM351	YBD152	YBD252	YBG102	YB9320	YBG205	YBG202			YBG212	YBG302	YBG152	YBG252	YNG151	YNG151C	YC30S
	ZDET08T2CYR10	6.75	8.4	2.78	10	2.8	14°																					
	ZDET1103CYR12.5	8.5	10.6	3.18	12.5	2.8	14°																					
	ZDET13T3CYR16	10.5	13.2	3.97	16	4.4	14°																					
	ZDET13T3CYR16-PM	10.5	13.2	3.97	16	4.4	14°															●						

● Ex Stock / ab Lager ○ On demand / auf Anfrage

ZP**

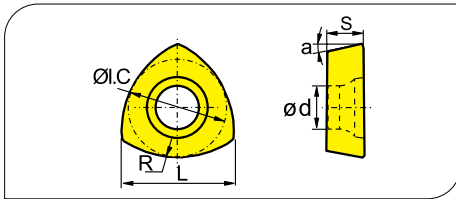

Workpiece Material Werkstoffe	Ideal Machining Condition Gute Bearbeitungsbedingungen			Normal Machining Condition Normale Bearbeitungsbedingungen			Unfavorable Machining Condition Ungünstige Bearbeitungsbedingungen								
	P	M	K	N	S	P	M	K	N	S	P	M	K	N	S
P Steel Stahl	●	●	●	●	●	●	●	●	●	●	●	●	●	●	●
M Stainless Steel Rostfreier Stahl	●	●	●	●	●	●	●	●	●	●	●	●	●	●	●
K Cast iron Gusseisen	●	●	●	●	●	●	●	●	●	●	●	●	●	●	●
N Non-ferrous material Nichte Metalle	●	●	●	●	●	●	●	●	●	●	●	●	●	●	●
S Heat-resistant steel Warmfester Stahl	●	●	●	●	●	●	●	●	●	●	●	●	●	●	●

Insert WSP	Type Typ	Dimensions (mm) Abmessungen						CVD Coating CVD Beschicht.						PVD Coating PVD Beschicht.						Cermet Cermet	Carbide uncoat. unbe. Hartmetall							
		I.C	L	S	R	d	α	YBC302	YBC301	YBC401	YBM253	YBM251	YBM351	YBD152	YBD252	YBG102	YB9320	YBG205	YBG202			YBG212	YBG302	YBG152	YBG252	YNG151	YNG151C	YC30S
	ZPNT2204CY(R20)	12.7	16.1	4.76	20	5.56	11°																					
	ZPNT2204CY(R25)	12.7	16.9	4.76	25	5.56	11°																					
	ZPNT2204CY(R31)	12.7	17.6	4.76	31.5	5.56	11°																					

ZO**

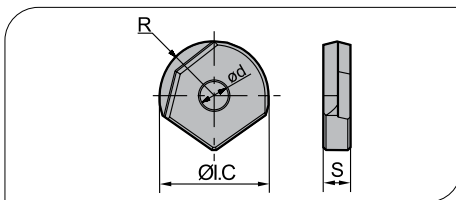

Workpiece Material Werkstoffe	Ideal Machining Condition Gute Bearbeitungsbedingungen			Normal Machining Condition Normale Bearbeitungsbedingungen			Unfavorable Machining Condition Ungünstige Bearbeitungsbedingungen								
	P	M	K	N	S	P	M	K	N	S	P	M	K	N	S
P Steel Stahl	●	●	●	●	●	●	●	●	●	●	●	●	●	●	●
M Stainless Steel Rostfreier Stahl	●	●	●	●	●	●	●	●	●	●	●	●	●	●	●
K Cast iron Gusseisen	●	●	●	●	●	●	●	●	●	●	●	●	●	●	●
N Non-ferrous material Nichte Metalle	●	●	●	●	●	●	●	●	●	●	●	●	●	●	●
S Heat-resistant steel Warmfester Stahl	●	●	●	●	●	●	●	●	●	●	●	●	●	●	●

Insert WSP	Type Typ	Dimensions (mm) Abmessungen				CVD Coating CVD Beschicht.						PVD Coating PVD Beschicht.						Cermet Cermet	Carbide uncoat. unbe. Hartmetall									
		R	I.C	S	d	YBC302	YBC301	YBC401	YBM253	YBM251	YBM351	YBD152	YBD252	YBG102	YB9320	YBG205	YBG202			YBG212	YBG302	YBG152	YBG252	YNG151	YNG151C	YC30S	YD101	YD201
	ZOHX1203-GF	6	12	3	4																							
	ZOHX1604-GF	8	16	4	5																							
	ZOHX2005-GF	10	20	5	5																							
	ZOHX2506-GF	12.5	25	6	6																							
	ZOHX3007-GF	15	30	7	8																							
	ZOHX3207-GF	16	32	7	8																							
	ZOHX1203-GM	6	12	3	4																							
	ZOHX1604-GM	8	16	4	5																							
	ZOHX2005-GM	10	20	5	5																							
	ZOHX2506-GM	12.5	25	6	6																							
	ZOHX3007-GM	15	30	7	8																							
	ZOHX3207-GM	16	32	7	8																							

Applicable tool B11-B18
Werkzeug

Tools code key B202-B203
WSP ISO

Grade selection guide B19-B23
Sortenauswahl

Technical data B236-B241
Technische Daten

Difference and selection between down milling and up milling Unterschied zwischen Gleichlauf- und Gegenlauf

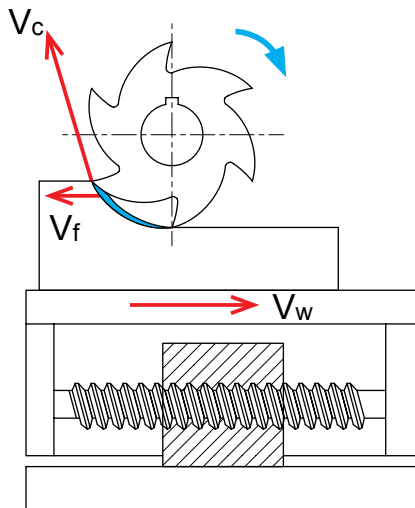

**Up milling
Gegenlaufräsen**

Up milling (conventional milling): the feed direction of workpiece is opposite to that of the milling rotation at the connecting position.

Beim Gegenlaufräsen ist die Drehrichtung des Fräsers und die Vorschubrichtung des Werkstücks entgegengesetzt.

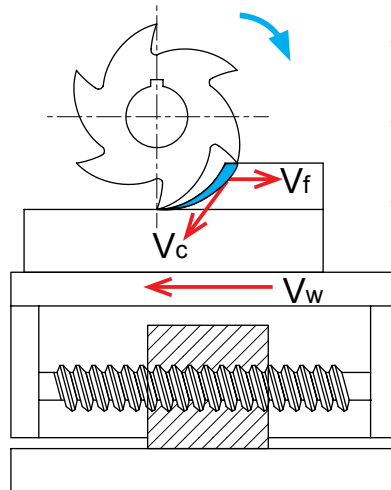

**Down milling
Gleichlaufräsen**

Down milling (climb milling): the feed direction of workpiece is the same as that of the milling rotation at the connecting position.

Beim Gleichlaufräsen sind die Drehrichtung des Fräsers und die Vorschubrichtung des Werkstücks gleich gerichtet.

V_c = Cutting Speed
Schnittgeschwindigkeit

V_f = Feedrate tool
Vorschub Werkzeug

V_w = Feedrate Workpiece
Vorschub Werkstück



Advantage and Disadvantage · Vor- und Nachteile :

Direction Richtung	Advantage Vorteil	Disadvantage Nachteil
Up milling Gegenlaufräsen	Prevent hooking of tool, more smooth cut Verhindert das Einhaken des Werkzeugs, ruhigerer Lauf	Bigger stress on cutting edge, tool life shorter Größere Belastung für den Schneidstoff, kürzere Standzeiten
Down milling Gleichlaufräsen	Higher tool life, less thermal stress Höhere Standzeiten, weniger thermische Belastung	Hooking of tool possible Einhaken des Werkzeugs möglich

Pitch selection · Fräserteilung

Pitch is the distance between one point on one cutting edge and the same point on the next edge. Milling cutters are mainly classified into coarse, fine and extra fine pitches.

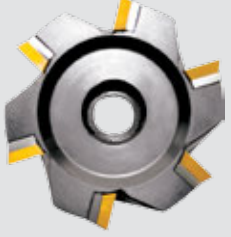
Als Fräserteilung wird der Abstand von einer Schneidenecke zur nächsten Schneidenecke bezeichnet. Die Einteilung erfolgt in weite (differential), enge und extra enge Teilung.

Operational stability · Bearbeitungsstabilität		
L (Low / Niedrig)	M (Medium / Mittel)	H (High / Hoch)
<p>Coarse pitch · weite Teilung</p>  <p>(Differential Pech)</p>	<p>Fine pitch · Enge Teilung</p> 	<p>Extra fine pitch Extra Enge Teilung</p> 
<p>When the milling width equal to diameter of cutter, the machining system is stable and main power of machine is sufficient, selecting coarse pitch can achieve high productive efficiency.</p> <p>Ist die Fräsbreite gleich dem Fräserdurchmesser, die Maschinen in sich stabil, und mit genügend Leistung, wird eine weite Teilung verwendet, um eine hohe Produktivität zu erreichen.</p>	<p>General milling function and multiple mixed productions</p> <p>Erste Wahl für allgemeine Fräsbearbeitung und Mischbearbeitung</p>	<p>When the milling width is less than diameter of cutter, cutting by maximum edges can achieve high productive efficiency.</p> <p>Ist die Fräsbreite kleiner als der Fräserdurchmesser, ermöglicht eine große Schneidanzahl eine hohe Produktivität. Für alle Materialien geeignet, besonders auch bei hochwarmfesten Werkstoffen.</p>

Selection of approach angle · Einstellwinkel

The approach angle is composed by insert and tool body, Chip thickness, cutting forces and tool-life are affected especially by the approach angle. Decreasing the approach angle reduces chip thickness and spreads the cutting area between cutting edge and workpiece for a given feed rate.

A smaller approach angle also guarantee that it is stable entering into or exiting workpiece, to protect the cutting edge and extend tool life. However this will increase higher axial cutting forces on the workpiece, thus is not suitable for machining thin workpiece such as thin plate.

Approach angle	Feed rate per tooth Zahnvorschub	Real max. cutting depth Max. Spandicke
90°	f_z	$h_{ex} = f_z \times \sin \alpha$
75°	f_z	$h_{ex} = 0.96 \times f_z$
60°	f_z	$h_{ex} = 0.86 \times f_z$
45°	f_z	$h_{ex} = 0.707 \times f_z$
Round insert	f_z	$h_{ex} = \frac{\sqrt{i C^2 \times (i C - 2 a_p)^2}}{i C} \times f_z$

Der Einstellwinkel eines Planfräasers steht in Verbindung mit der Spandicke. Dies ist der Winkel zwischen der Hauptschneide der Wendschneidplatte und der Werkstückoberfläche. Spandicke, Schnittkräfte und Standzeit werden insbesondere durch den Einstellwinkel beeinflusst. Durch Verringern des Einstellwinkels wird die Spandicke bei einer gegebenen Vorschubrate kleiner. Dieser Effekt führt dazu, dass sich die Werkstückstoffmenge über einen größeren Teil der Schneidkante verteilt. Ein kleiner Einstellwinkel sorgt auch für einen weniger abrupten Eintritt in den Schnitt, wodurch der radiale Druck sinkt und die Schneidkante geschont wird. Die höheren axialen Kräfte verstärken jedoch den Druck auf das Werkstück. Für die Bearbeitung von dünnwandigen Bauteilen nicht geeignet.

Milling · Fräsen

Indexable Milling Tools · Wendepplattenfräser

General formula · Allgemeine Formeln

V_c : cutting speed (m/min) Schnittgeschwindigkeit (m/min)	V_f : feed rate of worktable (feed speed) (mm/min) Vorschub Maschinentisch (feed speed) (mm/min)
D_c : nominal diameter of milling tool (mm) Sollmaß von Fräswerkzeugen (mm)	f_z : feed rate per tooth (mm/z) Zahnvorschub (mm/z)
n : spindle speed (rev/min) Umdrehungsgeschwindigkeit (u/min)	π : circumference ratio ≈ 3.14 Kreiszahl $\sim 3,4$
z_n : number of teeth Zähne Anzahl	T_c : machining time (min) Bearbeitungszeit (min)
Q : metal removal rate (cm ³ /min) Material Abtragsrate (cm ³ /min)	f_n : feed rate per revolution (mm/rev) Vorschub pro Umdrehung (mm/u)

- Cutting speed · Schnittgeschwindigkeit

$$V_c = \frac{\pi \times D_c \times n}{1000} \text{ (m/min)}$$

- Spindle speed · Umdrehungsgeschwindigkeit

$$n = \frac{1000 \times V_c}{\pi \times D_c} \text{ (rev/min)}$$

- Feed rate of worktable (feed speed)

- Vorschub des Maschinentisches

$$V_f = f_z \times n \times z_n \text{ (mm/min)}$$

- Feed rate per tooth · Zahnvorschub

$$f_z = \frac{V_f}{n \times z_n} \text{ (mm/z)}$$

- Feed rate per revolution · Vorschub pro Umdrehung

$$f_n = \frac{V_f}{n} \text{ (mm/rev)}$$

- Machining time · Bearbeitungszeit

$$T_c = \frac{1000 \times V_c}{\pi \times D_c} \text{ (min)}$$

- Metal removal rate · Zerspanungsvolumen

$$Q = \frac{a_p \times a_e \times V_f}{1000} \text{ (cm}^3\text{/min)}$$

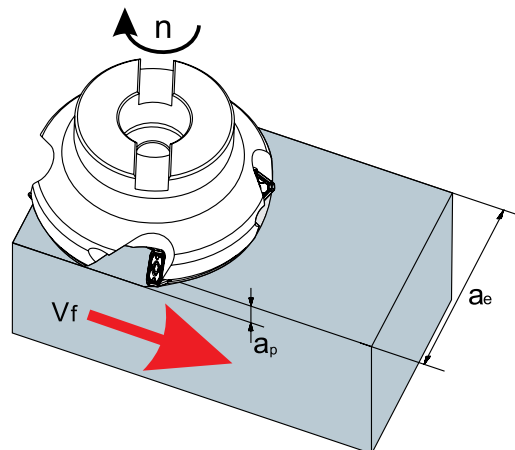

Feed direction
Vorschubrichtung

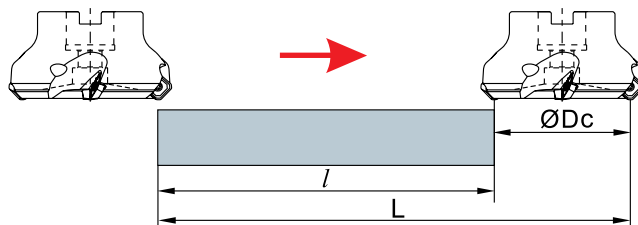
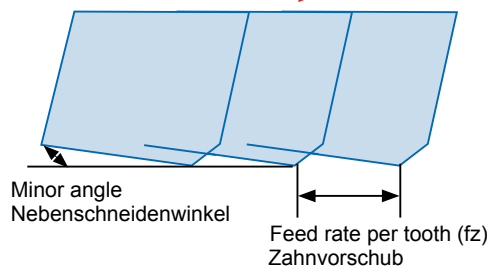

B

Milling Tools
Fräser

Function of each part in face milling · Winkelfunktion beim Planfräsen

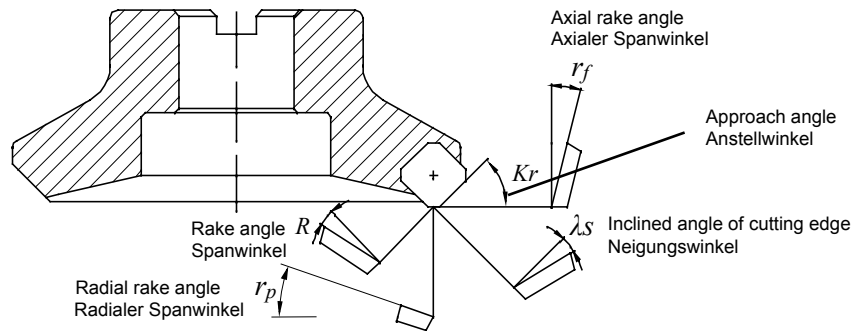

Main angles of face mills · Winkel beim Planfräsen

Designation Winkel	Function Funktion	Effect Auswirkung		
Axial rake angle Axialer Spanwinkel r_f	Determining the chip direction Beeinflusst die Spanflußrichtung	negative angle, excellent chip removal Negativer <Spanwinkel, gute Späneabfuhr		
Radial rake angle Radialer Spanwinkel r_p	Determining sharpness of cutting edge Definiert die Schneidenschärfe	Positive angle, good cutting performance Positive Winkel, gute Schnittleistung		
Approach angle Anstellwinkel Kr	Determining the chip thickness Beeinflusst die Spandicke	$Kr \uparrow$, chip thickness \uparrow , $Kr \downarrow$, chip thickness \downarrow ; $Kr \uparrow$, Spandicke \uparrow , $Kr \downarrow$, Spandicke \downarrow ;		
Rake angle Spanwinkel R	Determining true sharpness of cutting edge Beeinflusst die wahre Plattenschärfe	Poor cutting performance, high strength of cutting edge Schlechte Schnittleistung, starke Schneidkante	(-) \leftarrow 0 \rightarrow (+)	Good cutting performance, low strength of cutting edge Gute Schnittleistung, schwächere Schneidkante
Inclined angle of cutting edge Neigungswinkel λ_s	Determining the chip flow direction Beeinflusst die Spanflußrichtung	Poor cutting performance, high strength of cutting edge Schlechte Schnittleistung, starke Schneidkante	(-) \leftarrow 0 \rightarrow (+)	Good cutting performance, low strength of cutting edge Gute Schnittleistung, schwächere Schneidkante

Combination of different rake angles · Kombination von verschiedenen Spanwinkeln

Negative rake angle Negativer Spanwinkel		Double positive Doppelt Positiv	Double negative Doppelt Negativ	One pos., one neg. Positiv / Negativ
0° rake angle Neutraler Winkel				
Positive rake angle Positiver Spanwinkel				
Axial rake angle r_f / axialer Spanwinkel		+	-	+
Radial rake angle r_p / radialer Spanwinkel		+	-	-
Applicable material machined Anwendungsbereich	P	✓		✓
	M	✓		✓
	K		✓	✓
	N	✓		
	S	✓		✓

Cutting performances of different approach angles Schneidleistung bei verschiedenen Anstellwinkeln

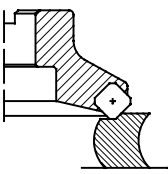
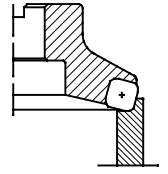
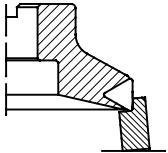
Approach angle Anstellwinkel	Schematic diagram Darstellung	Instruction Erklärung
45°		<p>Axial force is largest. It will bend when machining thin-wall workpiece, and reduces the precision of workpiece. It is benefit to avoid fringe breakage of workpiece when machining cast iron</p> <p>Die axiale Kraft ist sehr hoch. Wegen der Verbiegung nicht geeignet für die Bearbeitung von dünnwandigen Bauteilen. Optimal für die Planbearbeitung von Stahl, Guss und rostfreien Materialien.</p>
75°		<p>The main purpose is to resolve the radial cutting force, it is often used for general face milling.</p> <p>Zur Reduzierung der radialen Kräfte. Für die allgemeine Planbearbeitung.</p>
90°		<p>The axial force is zero in theory, suitable for milling thin plate workpiece.</p> <p>Die axiale Kraft ist nahezu null. Für die Zerspaltung von dünnen, labilen Werkstücken geeignet.</p>

Wiper insert · Wiper Platte

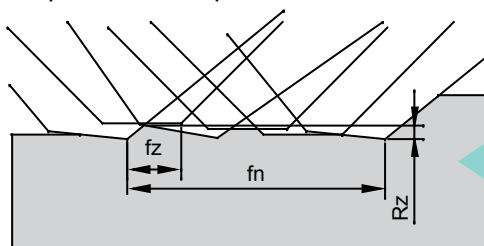

Required surface roughness with common insert isn't achieved.

Geforderte Oberflächengüte mit herkömmlichen Platten wird nicht erreicht.

Solution · Lösung

Assembling wiper inserts
Einsatz von Wiperplatten

usage · Anwendung

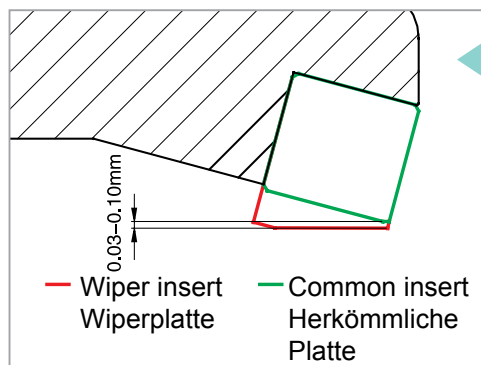

The wiper insert must protrude below the other inserts by 0.03-0.10 mm at axial direction, only that the wiping function can take into effect.

Generally speaking, a cutter can just assemble only one wiper insert. If the diameter of cutter is much bigger or cutter's feed rate per revolution is bigger than the length of wiper edge, 2 to 3 wiper inserts can be assembled.

Die Wiperplatte muss ca. 0,03 – 0,1 mm über den normalen Platten in axialer Richtung stehen, um den Wipereffekt zu erreichen.

Bei Standarddurchmessern reicht eine Wiperplatte.
Bei sehr großen Fräserdurchmessern oder großen Vorschubraten können bis zu 3 Wiperplatten eingesetzt werden.

Selection of cutting width and tool cutting diameter in face milling

Schnittbreiten - Auswahl und Werkzeug - Durchmesser beim Planfräsen

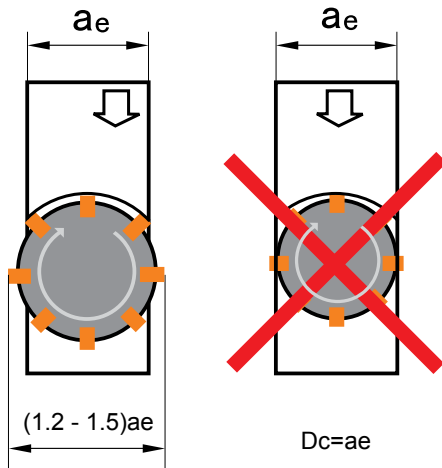

Generally speaking, the relation between cutting width and tool cutting diameter is $D_c = (1.2 - 1.5) a_e$. In the machining practice, it need to avoid coincidence of tool center and workpiece center as much as possible.

In der allgemeinen Anwendung sollte der Fräserdurchmesser 1.2 – 1,5 mal a_e betragen.
Positionieren Sie den Fräser leicht außermittig.

D_c : Diameter of milling tool · Werkzeugdurchmesser

a_e : Cutting width · Seitliche Zustellung

Threading pre-hole diameter · Kernlochdurchmesser

- Metric Coarse thread
- Metrisch - Gewinde

- Metric fine screw fine
- Metrisch - Feingewinde

Thread code Gewindebez.	Pre-hole diameter (mm) Kerndurchmesser
M3×0.5	2.5
M3.5×0.6	2.9
M4×0.7	3.3
M5×0.8	4.2
M6×1.0	5.0
M7×1.0	6.0
M8×1.25	6.75
M9×1.25	7.75
M10×1.5	8.5
M11×1.5	9.5
M12×1.75	10.25
M14×2.0	12.0
M16×2.0	14.0
M18×2.5	15.5
M20×2.5	17.5
M24×3.0	21.0
M27×3.0	24.0
M30×3.5	26.5

Thread code Gewindebez.	Pre-hole diameter (mm) Kerndurchmesser
M3×0.35	2.65
M3.5×0.35	3.15
M4×0.5	3.5
M4.5×0.5	4.0
M5×0.5	4.5
M5.5×0.5	5.0
M6×0.75	5.25
M7×0.75	6.25
M8×1.0	7.0
M8×0.75	7.25
M9×1.0	8.0
M9×0.75	8.25
M10×1.25	8.75
M10×1.0	9.0
M10×0.75	9.25
M11×1.0	10.0
M11×0.75	10.25
M12×1.5	10.5
M12×1.25	10.75
M12×1.0	11.0

Thread code Gewindebez.	Pre-hole diameter (mm) Kerndurchmesser
M14×1.5	12.5
M14×1.0	13.0
M15×1.5	13.5
M15×1.0	14.0
M16×1.5	14.5
M16×1.0	15.0
M17×1.5	15.5
M17×1.0	16.0
M18×2.0	16.0
M18×1.5	16.5
M18×1.0	17.0
M20×2.0	18.0
M20×1.5	18.5
M20×1.0	19.0
M22×2.0	20.0
M22×1.5	20.5
M22×1.0	21.0
M24×2.0	22.0
M24×1.5	22.5
M24×1.0	23.0

Surface roughness · Oberflächenrauigkeit

D

Technical Info
Technische Info

Type Typ	Code	Calculation method · Berechnungsmethode	Calculation example (figure) · Meßaufnahme (Abb.)
Arithmetic average deviation of profile Mittlere Rauhtiefe	Ra	<p>Within sampling length l, the arithmetic average absolute value of profile deviation is</p> $R_a = \frac{1}{l} \int_0^l y(x) dx$ <p>In the formula, the profile deviation y is the distance between profile points and reference line in the measuring direction. Reference line is the profile least-square average line O. This line divide the profile and make the sum of squares of profile deviation to be the minimum within the sampling length.</p> <p>Der Mittelrauhwert R_a ist der arithmetische Mittelwert der absoluten Beträge der Abstände y des Rauheitsprofils von der Mittellinie innerhalb der Messstrecke. Dies ist gleichbedeutend mit der Höhe des Rechtecks, dessen Länge gleich der Gesamtstrecke l ist und das flächengleich mit der Summe der zwischen dem Rauheitsprofil und der Mittellinie eingeschlossenen Fläche ist $y=f$</p>	
Irregularity ten-point high Gemittelte Rauhtiefe	Rz	<p>Within sampling length l, the sum of the average value of heights of five highest profile peak and the depths of five deepest profile valleys</p> $R_z = \frac{\sum_{i=1}^5 y_{pi} + \sum_{i=1}^5 y_{vi}}{5}$ <p>In the formula, y_{pi} means the height of 'i'th highest profile peak. In the formula, y_{vi} means the depth of 'i'th deepest profile valley.</p> <p>Maximum height of profile R_y: the distance between the top profile peak line and the bottom profile valley line in the longitudinal direction within the sampling length l.</p> <p>Die gemittelte Rauhtiefe R_z ist das arithmetische Mittel aus den Einzelrauhtiefen fünf aufeinander grenzender Einzelmessstrecken gleicher Länge. R_z wird ebenfalls in (μm) angegeben.</p>	
Maximum height of profile Maximale Rauhtiefe	Ry	<p>The distance between the inner profile peak line and the bottom profile valley line in the longitudinal direction within the sampling length l.</p> <p>Top profile peak line is the line that parallels to the reference line and passes through the highest point of profile peak.</p> <p>Bottom profile line is the line that parallels to the reference line and passes through the lowest point of profile valley.</p> <p>Die maximale Rauhtiefe R_y ist die größte der auf der Gesamtmeßstrecke l vorkommenden Einzelrauhtiefen, R_y wird auch in (μm) Mikrometer angegeben. (Bemerkung) Um R_z herausfinden, wird ein Anteil ohne außergewöhnliche Höhen und Tiefen als Stichprobenlänge ausgewählt und als Schwachstelle betrachtet.</p>	

General Technical Inform ▪ Allgemeine Technische Info

Material comparison table · Werkstoffe Vergleichstabelle

ISO	Country and Standard · Standardbezeichnung nach Länder											
	China	USA	Germany		Great Britain		Sweden	France	Italy	Spain	Japan	Russia
	GB	AISI/SAE	W.-nr	DIN	BS	EN	SS	AFNOR	UNI	UNE	JIS	GOST
P	Alloy steel · Legierter Stahl											
	15	1015	1.0401	C15	080M15	-	1350	CC12	C15C16	F.111	-	-
	20	1020	1.0402	C22	050A20	2C	1450	CC20	C20C21	F.112	-	20
	35	1035	1.0501	C35	060A35	-	1550	CC35	C35	F.113	-	35
	45	1045	1.0503	C45	080M40	-	1650	CC45	C45	F.114	-	45
	55	1055	1.0535	C55	070M55	-	1655	-	C55	-	-	55
	60	1060	1.0601	C60	080A62	43D	-	CC55	C60	-	-	60
	Y15	1213	1.7015	9SMn28	230M07	-	1912	S250	CF9SMn28	11SMn28	SUM22	15Ch
	-	12L13	1.0718	9SMnPb28	-	-	1914	S250Pb	CF9MnPb28	11SMnPb28	SUM22L	-
	-	-	1.0722	10SPb20	-	-	-	10PbF2	CF10Pb20	10SPb20	-	-
	-	1140	1.0726	35S20	212M36	8M	1957	35MF4	-	F210G	-	-
	Y13	1215	1.0736	9SMn36	240M07	1B	-	S300	CF9SMn36	12SMn35	-	-
	-	12L14	1.0737	9SMnPb36	-	-	1926	S300Pb	CF9SMnPb36	12SMnP35	-	-
	55Si2Mn	9255	1.0904	55Si9	250A53	45	2085	55S7	55Si8	56Si7	-	-
	-	9262	1.0961	60SiCr7	-	-	-	60SC7	60SiCr8	60SiCr8	-	-
	15	1015	1.1141	Ck15	080M15	32C	1370	XC12	C16	C15K	S15C	15
	40Mn	1039	1.1157	40Mn4	150M36	15	-	35M5	-	-	-	40G
	25	1025	1.1158	Ck25	-	-	-	-	-	-	S25C	25
	35Mn2	1335	1.1167	36Mn5	-	-	2120	40Mn5	-	36Mn5	SMn438(H)	35G2,35GL
	30Mn	1330	1.1170	28Mn6	150M28	14A	-	20M5	C28Mn	-	SCMn1	30G
	35Mn	1035	1.1183	Cf35	060A35	-	1572	XS38TS	C36	-	S35C	-
	Ck45	1045	1.1191	45	080M46	-	1672	XC42	C45	C45K	S45C	-
	55	1055	1.1203	Ck55	070M55	-	-	XC45	C50	C55K	S55C	55
	50	1050	1.1213	Cf53	060A52	-	1674	XC48TS	C53	-	S50C	-
	60Mn	1060	1.1221	Ck60	080A62	43D	1678	XC60	C60	-	S58C	60,60G
	-	1095	1.1274	Ck101	060A96	-	1870	-	-	-	SUP4	-
	-	-	1.3401	X120Mn12	Z120M12	-	-	X120M12	XG120Mn12	X120Mn12	SCMnH/1	110G13L
	Gr15;45Gr	52100	1.3505	100Cr6	534A99	31	2258	100C6	100Cr6	F.131	SUJ2	SchCh 15
	-	ASTM A204Gr.A	1.5415	15Mo3	1501-240	-	2912	15D3	16Mo3KW	16Mo3	-	-
	-	4520	1.5426	16Mo5	1503-245-420	-	-	-	16Mo5	16Mo5	-	-
-	ASTM A350LF5	1.5622	14Ni6	-	-	-	16N6	14Ni6	15Ni6	-	-	
-	ASTM A353	1.5662	X8Ni9	1501-509;510	-	-	-	X10Ni9	XBNi09	-	-	

D

Technical Info
Technische Info

General Technical Inform - Allgemeine Technische Info

Material comparison table · Werkstoffe Vergleichstabelle

ISO	Country and Standard · Standardbezeichnung nach Länder											
	China	USA	Germany		Great Britain		Sweden	France	Italy	Spain	Japan	Russia
	GB	AISI/SAE	W.-nr	DIN	BS	EN	SS	AFNOR	UNI	UNE	JIS	GOST
P	Alloy steel · Legierter Stahl											
	-	2515	1.5680	12Ni19	-	-	-	Z18N5	-	-	-	-
	-	3135	1.5710	36NiCr6	640A35	111A	-	35NC6	-	-	SNC236	-
	-	3415	1.5732	14NiCr10	-	-	-	14NC11	16NiCr11	15NiCr11	SNC415(H)	-
	-	3415 3310	1.5752	14NiCr14	655M13 655A12	36A	-	12NC15	-	-	SNC815(H)	-
	-	9840	1.6511	36CrNiMo4	816M40	110	-	40NCD3	38CrNiMo4(KB)	35CrNiMo4	-	40 ChN2MA
	-	8620	1.6523	21NiCrMo2	850M20	362	2503	20NCD2	20NiCrMo2	20NiCrMo2	SNCCM220(H)	-
	-	8740	1.6546	40NiCrMo2	311-Type7	-	-	-	40NiCrMo2(KB)	40NiCrMo2	SNC240	38ChGNM
	40CrNiMoA	4340	1.6582	34CrNiMo6	817M40	24	2541	35NCD6	35CrNiMo6(KB)	-	-	38Ch2N2MA
	-	-	1.6587	17CrNiMo6	820A16	-	-	18NCD6	-	14CrNiMo13	-	-
	15Cr	5015	1.7015	15Cr3	523M15	-	-	12C3	-	-	SCr415(H)	15Ch
	35Cr	5132	1.7033	34Cr4	530A32	18B	-	32C4	34Cr4(KB)	35Cr4	SCr430(H)	35Ch
	40Cr	5140	1.7035	41Cr4	530M40	18	-	42C4	41Cr4	42Cr4	SCr440(H)	40Ch
	40Cr	5140	1.7045	42Cr4	-	-	2245	-	-	42Cr4	SCr440	40Ch
	18CrMn	5115	1.7131	16MnCr15	(527M20)	-	2511	16MC5	16MnCr15	16MnCr15	-	18ChG
	20CrMn	5155	1.7176	55Cr3	527A60	48	-	55C3	-	-	SUP9(A)	50ChGA
	30CrMn	4130	1.7218	25CrMo4	1717CDS110	-	2225	25CD4	25CrMo4(KB)	55Cr3	SCM420; SCM430	30ChM
	35CrMo	4137;4135	1.7220	34CrMo4	708A37	19B	2234	35CD4	35CrMo4	34CrMo4	SCM432; SCRMM3	AS38ChGM
	40CrMoA	4140;4142	1.7223	41CrMo4	708M40	19A	2244	42CD4TS	41CrMo4	41CrMo4	SCM440	40 ChFA
	42CrMo 42CrMnMo	4140	1.7225	42CrMo4	708M40	19A	2244	42CD4	42CrMo4	42CrMo4	SCM440(H)	-
	-	-	1.7262	15CrMo5	-	-	2216	12CD4	-	12CrMo4	SCM415(H)	-
	-	ASTM A182 F11;F12	1.7335	13CrMo44	1501-620Gr.27	-	-	15CD3.5; 15CD4.5	14CrMo44	14CrMo45	-	12ChM , 15ChM
	-	-	1.7361	32CrMo12	722M24	40B	2240	30CD12	32CrMo12	F.124.A	-	-
	-	ASTM A182 F.22	1.7380	10CrMo910	1501- 622Gr.31;45	-	2218	12CD9;10	12CrMo9,10	TU.H	-	-
	-	-	1.7715	14MoV63	1503-660-440	-	-	-	-	13MoCrV6	-	-
	50CrVA	6150	1.8159	50CrV4	735A50	47	2230	50CV4	50CrV4	51CrV4	SUP10	50ChGFA
	-	-	1.8509	41CrAlMo7	905M39	41B	2940	40CAD6,12	41CrAlMo7	41CrAlMo7	-	38ChMJuA
	-	-	1.8523	39CrMoV139	897M39	40C	-	-	36CrMoV12	-	-	-

D

Technical Info
Technische Info

Material comparison table · Werkstoffe Vergleichstabelle

ISO	Country and Standard · Standardbezeichnung nach Länder											
	China	USA	Germany		Great Britain		Sweden	France	Italy	Spain	Japan	Russia
	GB	AISI/SAE	W.-nr	DIN	BS	EN	SS	AFNOR	UNI	UNE	JIS	GOST
P	Tool steel · Werkzeugstahl											
	T10	W.110	1.1545	C105W1	-	-	1880	Y1105	C98KU C100KU	F.515 F.516	-	U10A
	T12A	W.112	1.1663	C125W	-	-	-	Y2120	C120KU	(C120)	SK2	U13
	CrV;9SiCr	L3	1.2067	100Cr6	BL3	-	-	Y100C6	-	100Cr6	-	-
	Cr12	D3	1.2080	X210Cr12	BD3	-	-	Z200Cr12	X210Cr13KU X250Cr12KU	X210Cr12	SKD1	Ch12
	4Cr5MoVSi	H13	1.2344	X40CrMoV5 1	BH13	-	2242	Z40CDV5	X35CrMoV05KU X40CrMoV51KU	X40CrMoV5	SKD61	4Ch5MF1S
	Cr6WV	A2	1.2363	X100CrMoV5 1	BA2	-	2260	Z100CDV5	X100CrMoV51KU	X100CrMoV5	SKD12	-
	CrWMo	-	1.2419	105WCr6	-	-	2140	105WC13	10WCr6 107WCr5KU	105WCr5	SKS31 SKS2 SKS3	ChWG
	Cr12W	-	1.2436	X210CrW12	-	-	2312	-	X215CrW12 1KU	X210CrW12	SKD2	-
	5CrNiMo	S1	1.2542	45WCrV7	BS1	-	2710	-	45WCrV8KU	45WCrSi8	-	-
	3Cr2W8V	H21	1.2581	X30WCrV9 3 X30WCrV93KU	BH21	-	-	Z30WCV9	X28W09KU X30WCrV9 3KU	X30WCrV9	SKD5	3Ch2W8F
	Cr12MoV	-	1.2601	X165CrMoV 12	-	-	2310	-	X165CrMoW12KU	X160CrMoV12	SKD11	-
	5CrNiMo	L6	1.2713	55NiCrMoV6	-	-	-	55NCDV7	-	F.250.S	SKT4	5ChNM
	V	W210	1.2833	100V1	BW2	-	-	Y1105V	-	-	SKS43	-
	W6Mo5Cr4V2Co5	-	1.3243	S6-5-2-5	-	-	2723	Z85WDCV	HS6-5-2-5	HS6-5-2-5	SKH55	R6M5K5
	W18Cr4VCo5	T4	1.3255	S18-1-2-5	BT4	-	-	Z80WKCV 10-05-04-01	X78WCo1805KU	HS18-1-1-5	SKH3	-
	W6Mo5Cr4V2	M2	1.3343	S6-5-2	BM2	-	2722	Z85WDCV 06-05-04-02	X82WMo0605KU	HS6-5-2	SKH9	R6M5
	-	M7	1.3348	S2-9-2	-	-Z-	2782	Z100WCWV 09-02-04-02	HS2-9-2	HS2-9-2	-	-
	W18Cr4V	T1	1.3355	S18-0-1	BT1	-	-	Z80WCV 18-04-01	X75W18KU	HS18-0-1	SKH2	-
	W6Mo5Cr4V3	M3	-	S6-5-3	-	-	-	-	-	-	SKH52	-
-	M42	-	-	BM42	-	-	-	-	-	SKH59	-	

General Technical Inform - Allgemeine Technische Info

D

Technical Info
Technische Info

ISO	Country and Standard · Standardbezeichnung nach Länder						Main application Hauptanwendung
	China	USA	Germany	Japan	Daido Steel Co., Ltd (Japan)	Russia	
	GB	AISI/SAE	DIN	JIS	DAIDO	GOST	
P	Plastic die steel · Gesenkstahl						
	-	P20 mod.		-	PX5N		For mass production of large mirror dies. Automobile tail light, front fender of car, video camera, household electrical appliances etc Große hochglänzende Präzisionsgesenke für die Serienproduktion. Automobilteile, Videokameras, elektr. Haushaltsgeräte ect.
	-	-		-	NAK55		High precision mirror die. Video camera, music disc, Cosmetic Containers, transparent covers, transparent films etc Hochglänzende Präzisionsgesenke für Videokameras, Musik CDs, Kosmetik Behälter, Transparente Abdeckungen.
	-	-		-	NAK80		High precision mirror die. Video camera, music disc, Cosmetic Containers, transparent covers, transparent films etc Hochglänzende Präzisionsgesenke für Videokameras, Musik CDs, Kosmetik Behälter, Transparente Abdeckungen und Beläge.
	3Cr13	420 mod.		SUS420J2 mod.	S-STAR		For ultra-mirror corrosion resistant precise dies. Accessories of camera, CD, lens, watch case. Für ultra-fein spiegelnde korrosionsbeständige Gesenke für Zubehör von Kameras. CD, Linsen, Armbanduhren.
	Cold-working die steel · Kaltarbeitsstahl						
	-	02	-	SKS93	YK30		Stamping die, gauge calipers, paper cutter, auxiliary tools Für Gesenkstempel, Meßkaliber, Papierschnidmesser, Werkzeuge
	9CrWMn	01 mod.	-	SKS3 mod.	GOA		Blanking die, gauge calipers, drawing die, taps, Perforated punch. Für Schnittmatrizen, Meßkaliber, Gewindebohrer, Perforationswerkzeuge, Kaltziehsteine
	Cr12MoV	D2	X165CrMoV12	SKD11	DC11		Blanking die, cold forming die, cold drawing die, forming roller, punch Für Schnittmatrizen, Kaltformpressgesenke, Kaltziehsteine, Formwalzen.
	-	D2 mod.	-	SKD11 mod.	DC53		Blanking die, cold forming die, cold drawing die, forming roll, punch Für Schnittmatrizen, Kaltformpressgesenke, Kaltziehsteine, Formwalzen.
Hot-working die steel · Warmarbeitsstahl							
4Cr5MoSiV1	H13	X40CrMoV51	SKD61	DHA1		Aluminum-compression die, connecting parts of compression die, hot stamping die, hot extrusion die, thermal shear cutting blade Aluminium Druckgesenke, Verbindungsstücke für Druckgesenke, Heißpressgesenke, Heiß-Extruder-Gesenke, warmfeste Schnittmesser ect.	
-	-	-	-	DH21		Long life Aluminum compression die Alu-Druckgesenke für lange Lebensdauer	
-	-	-	-	DH31-S		Compression die, Druckgesenke	
-	-	-	-	DH2F		Compression die, plastic die Druckgesenke, Plastik-Gesenke	

General Technical Inform ▪ Allgemeine Technische Info

D

Technical Info
Technische Info

ISO	Country and Standard · Standardbezeichnung nach Länder											
	China	USA	Germany		Great Britain		Sweden	France	Italy	Spain	Japan	Russia
	GB	AISI/ SAE	W.-nr	DIN	BS	EN	SS	AFNOR	UNI	UNE	JIS	GOST
M	Stainless steel · Rostfreier Stahl											
	0Cr13; 1Cr12	403	1.4000	X6Cr13	403S17	-	2301	Z6C13	X6Cr13	F.3110	SUS403	08Ch13
	-	-	1.4001	X7Cr14	-	-	-	-	-	F.8401	-	-
	1Cr13	410	1.4006	X10Cr13	410S21	56A	2302	Z10C14	X12Cr13	F.3401	SUS410	12Ch13
	1Cr17	430	1.4016	X6Cr17	430S15	60	220	Z8C17	X8Cr17	F.3113	SUS430	12Ch17
	2Cr13	410	1.4021	X20Cr13	S62	56B; 56C	-	Z20C13	X20C13	F.3401	SUS410	20Ch13
	-	-	1.4027	G-X20Cr14	420C29	56B	-	Z20C13M	-	-	SCS2	20Ch13L
	4Cr13	-	1.4034	X46Cr13	420S45	56D	2304	Z40CM Z38C13M	X40Cr14	F.3405	SUS420J2	40Ch13
	1Cr17Ni2	431	1.4057	X20CrNi172	431S29	57	2321	Z15CNi6.02	X16CrNi16	F.3427	SUS431	20Ch17N2
	Y1Cr17	430F	1.4104	X12CrMoS17	-	-	2383	Z10CF17	X10CrS17	F.3117	SUS430F	-
	1Cr17Mo	434	1.4113	X6CrMo171	434S17	-	2325	Z8CD17.01	X8CrMo17	-	SUS434	-
	-	-	1.4313	X5CrNi134	425C11	-	-	Z4CND13.4M	-	-	SCS5	-
	-	-	1.4408	G-X6CrNiMo1810	316C16	-	-	-	-	F.8414	SCS14	07Ch18N10G2S2M2L
	4Cr9Si2	HW3	1.4718	X45CrSi93	401S45	52	-	Z45CS9	X45CrSi8	F.322	SUH1	40Ch9S2
	0Cr13Al	405	1.4724	X10CrAl13	403S17	-	-	Z10C13	X10CrAl12	F.311	SUS405	10Ch13SJ
	Cr17	430	1.4742	X10CrAl18	430S15	60	-	Z10CAS18	X8Cr17	F.3113	SUS430	15Ch18SJ
	8Cr20Si2Ni	HNV6	1.4757	X80CrNiSi20	443S65	59	-	Z80CSN20.02	X80CrSiNi20	F.320V	SUH4	-
	2Cr25N	446	1.4762	X10CrAl24	-	-	2322	Z10CAS24	X16Cr26	-	SUH446	-
	Austenitic stainless steel · Austenitischer Rostfreier Stahl											
	0Cr18Ni9	304	1.4301	X5CrNi1810	304S15	58E	2332	Z6CN18.09	X5CrNi1810	F.3551; F.3541; F.3504	SUS304	08Ch18N10
	1Cr18Ni9MoZr	303	1.4305	X10CrNiS189	303S21	58M	2346	Z10CNF18.09	X10CrNiS18.09	F.3508	SUS303	-
	0Cr19Ni10	304L	1.4306	X2CrNi1911	304S12	-	2352	Z2CN18.10	X2CrNi18.11	F.3503	SCS19	03Ch18N11
	-	-	1.4308	G-X6CrNi189	304C15	-	-	Z6CN18.10M	-	-	SCS13	07Ch18N9L
	Cr17Ni7	301	1.4310	X12CrNi177	-	-	2331	Z12CN17.07	X12CrNi1707	F.3517	SUS301	-
	-	304LN	1.4311	X2CrNiN1810	304S62	-	2371	Z2CN18.10	-	-	SUS304LN	-
	0Cr19Ni9	304	1.4350	X5CrNi189	304S31	58E	-	Z6CN18.09	X5CrNi1810	-	SUS304	-
	0Cr17Ni11Mo2	316	1.4401	X5CrNiMo1712	316S16	Z6CND17.11	2347	1.4401	X5CrNiMo1712	F.3543	SUS316	-
	00Cr17Ni13Mo2	316LN	1.4429	X2CrNiMo17133	-	-	2375	Z2CND17.13	-	-	SUS316LN	-
	0Cr27Ni12Mo3	316L	1.4435	X2CrNiMo18143	316S12	-	2353	Z2CDN17.13	X2CrNiMo1713	-	SCS16,	03Ch17N14M2
	00Cr19Ni13Mo3	317L	1.4438	X2CrNiMo17133	317S12	-	2367	Z2CND19.15	X2CrNiMo18.16	-	SUS317L	-
-	329L	1.4460	X8CrNiMo275	-	-	2324	-	-	-	SUS329L; SCH11; SCS11	-	
1Cr18Ni9Ti	321	1.4541	X6CrNiTi1810	2337	321S12	58B	Z6CNT18.10	X6CrNiTi1811	F.3553	SUS321	12Ch18N10T	
1Cr18Ni11Nb	347	1.4550	X6CrNiNb1810	347S17	58F	2338	Z6CNnb18.1	X6CrNiTi1811	F.3552	SUS347	08Ch18N12B	
1Cr18Ni12Mo2Ti	316Ti	1.4571	X6CrNiMoTi17122	320S17	58J	2350	Z6NDT17.12	X6CrNiMoTi17	F.3535	-	10Ch17N13M2T	

General Technical Inform - Allgemeine Technische Info

D

Technical Info
Technische Info

ISO	Country and Standard · Standardbezeichnung nach Länder												
	China	USA	Germany		Great Britain		Sweden	France	Italy	Spain	Japan	Russia	
	GB	AISI/SAE	W.-nr	DIN	BS	EN	SS	AFNOR	UNI	UNE	JIS	GOST	
M	Austenitic stainless steel · Austenitischer Rostfreier Stahl												
	-	-	1.4581	G-X5CrNiMoNb1810	318C7	-	-	-	Z4CNDNb1812M	XG8CrNiMo18	-	SCS22	-
	Cr17Ni12Mo3Nb	318	1.4583	X10CrNiMoNb1812	-	-	-	-	Z6CNDNb1713B	X6CrNiMoTiNb17	-	-	-
	1Cr23Ni13	309	1.4828	X15CrNiSi2012	309S24	-	-	-	Z15CNS20.1	-	-	SUH309	20Ch20N14S2
	0Cr25Ni20	310S	1.4845	X12CrNi2521	310S24	-	2361	-	Z12CN2520	X6CrNi2520	F.331	SUH310	20Ch23N18
	Cr15Ni36W3Ti	330	1.4864	X12NiCrSi3616	-	-	-	-	Z12CNS35.1	-	-	SUH330	-
	-	-	1.4865	G-X40NiCrSi3818	330C11	-	-	-	-	XG50NiCr3919	-	SCH15	-
	5Cr2Mn9Ni4N	EV8	1.4871	X53CrMnNiN219	349S54; 321S12	-	58B	-	Z52CMN21.0	X53CrMnNiN219	-	SUH35	55Ch20G9AN4
1Cr18Ni9Ti	321	1.4878	X12CrNiTi189	321S320	58C	-	-	Z6CNT18.12	X6CrNiTi1811	F.3523	SU321	09Ch18N10T	

ISO	Country and Standard · Standardbezeichnung nach Länder									
	China	USA	Germany	Great Britain	Sweden	France	Italy	Spain	Japan	Russia
K	Nodular cast iron · GGG									
	QT400-18	60-40-18	GGG40	400/17	0717-02	FGS370-17	GS370-17	FGE38-17	FCD400	VC 42-12
	QT450-10	65-45-12	--	420/12	--	FGS400-12	GS400-12	FGE42-12	FCD450	-
	QT500-7	70-50-05	GGG50	500/7	0727-02	FGS500-7	GS500-7	FGE50-7	FCD500	VC 50-2
	QT600-3	80-60-03	GGG60	600/7	0732-03	FGS600-2	GS600-2	FGE60-2	FCD600	VC 60-2
	QT700-2	100-70-03	GGG70	700/2	0737-01	FGS700-2	GS700-2	FGE70-2	FCD700	VC 70-2
	QT800-2	120-90-02	GGG80	800/2	0864-03	FGS800-2	GS800-2	FGE80-2	FCD800	VC 80-2
	QT900-2	--	--	900/2	--	--	--	--	--	-
	Grey cast iron · Grauguss									
	--	NO.60	GG40	--	0140	FGL400	--	--	--	Sc 40
	HT350	NO.50	GG35	350	0135	FGL350	G35	FG35	FC350	Sc 35
	HT300	NO.45	GG30	300	0130	FGL300	G30	FG30	FC300	Sc 30
	HT250	NO.35	GG25	250	0125	FGL250	G25	FG25	FC250	Sc 25
	HT200	NO.30	GG20	200	0120	FGL200	G20	FG20	FC200	Sc 20
	HT150	NO.20	GG15	150	0115	FGL150	G15	FG15	FC150	Sc 15
HT100	--	--	100	0110	--	G10	--	FC100	-	

ISO	Country and Standard · Standardbezeichnung nach Länder											
	China	USA	Germany		Great Britain		Sweden	France	Italy	Spain	Japan	Russia
	GB	AISI/SAE	W.-nr	DIN	BS	EN	SS	AFNOR	UNI	UNE	JIS	GOST
H	Hardened materials · Gehärtete Werkstoffe											
	-	440A	1.4108	X100CrMo03	-	-	2258 08	-	-	-	C4BS	-
	-	610	1.4111	X100CrMoV15	-	-	2534 05	-	-	-	AC4A	-
-	0-2	-	X65CrMo14	-	-	2541 06	-	-	-	AC4A	-	

General Technical Inform ▪ Allgemeine Technische Info

D

Technical Info
Technische Info

ISO	Country and Standard · Standardbezeichnung nach Länder											
	China	USA	Germany		Great Britain		Sweden	France	Italy	Spain	Japan	Russia
	GB	AISI/SAE	W.-nr	DIN	BS	EN	SS	AFNOR	UNI	UNE	JIS	GOST
N	Aluminium-based alloys · Aluminium Legierungen											
	-	SC64D	3.2373	G-AISI9MGWA			4251	A-S7G			C4BS	-
	-	DG-AISI12		G-ALMG5	LM5		4252	A-SU12			AC4A	
	-	356.1			LM25		4244				A5052	
	-	A413.0		GD-AISI12			4247				A6061	
	-	A380.1		GD-AISI8Cu3	LM24		4250				A7075	
	-	A413.1		G-AISI12(Cu)	LM20		4260				ADC12	
	-	A413.2		G-AISI12	LM6		4261					
	-	A360.2		G-AISI10Mg(Cu)	LM9		4253					

ISO	Country and Standard · Standardbezeichnung nach Länder											
	China	USA	Germany		Great Britain		Sweden	France	Italy	Spain	Japan	Russia
	GB	AISI/SAE	W.-nr	DIN	BS	EN	SS	AFNOR	UNI	UNE	JIS	GOST
S	Nickel based alloys · Nickel Legierungen											
	-	5391	LW2 4670	S-NiCr13A16MoNb	mar-46	-	-	NC12AD	-	-		
	-	AMS 5397	LW2 4674	NiCo15Cr10MoAlTi	-	-	-	-	-	-		
	-	5660	LW2.4662	NiFe35Cr14MoTi	-	-	-	ZSNCDT42	-	-		
	-	5383	LW2.4668	NiCr19Fe19NbMo	HR8	-	-	NC19eNB	-	-		
	-	-	2.4631	NiCr20TiAk	HR401.601	-	-	NC20TA	-	-		-
	-	AMS 5399	2.4973	NiCr19Co11MoTi	-	-	-	NC19KDT	-	-		-
	-	AMS 5544	LW2.4668	NiCr19Fe19NbMo	-	-	-	NC20K14	-	-		
	-	5390A	2.4603	-	-	-	-	NC22FeD	-	-		-
	-	5666	2.4856	NiCr22Mo9Nb	-	-	-	NC22FeDNB	-	-		-
	-	-	2.4630	NiCr20Ti	HR5.2034	-	-	NC20T	-	-		-
	-	4676	2.4375	NiCu30AL3Ti	3072-76	-	-	-	-	-		-
	Cobalt based alloys · Kobalt Legierungen											
	-	5537C AMS		CoCr20W15Ni	-	-	-	KC20WN	-	-		
	-	5772	LW2.4964	CoCr20W14Ni				KC22WN				
	Titanium alloys · Titanium Legierungen											
	-	UNS R54520	3.7115.1	TiAl5Sn2.5	TA14/17	-	-	T-A5E	-	-		
	-							UNS R56400				
	-	-	3.7165.1	TiAl6V4	TA10-13/ TA28		-	UNS R56401	T-A6V	-	-	
	-			TiAl5V5Mo5Cr3								
	-	-	3.7185	TiAl4Mo4Sn4Si0.5	-	-	-	-	-	-		

Fitting dimension tolerance · Passtoleranzen

Basic dimensions (mm)		Standard tolerance class of holes · Standard-Toleranzklassen																	
		IT1	IT2	IT3	IT4	IT5	IT6	IT7	IT8	IT9	IT10	IT11	IT12	IT13	IT14	IT15	IT16	IT17	IT18
>	≤	µm											mm						
---	3	0.8	1.2	2	3	4	6	10	14	25	40	60	0.1	0.14	0.25	0.4	0.6	1	1.4
3	6	1	1.5	2.5	4	5	8	12	18	30	48	75	0.12	0.18	0.3	0.48	0.75	1.2	1.8
6	10	1	1.5	2.5	4	6	9	15	22	36	58	90	0.15	0.22	0.36	0.58	0.9	1.5	2.2
10	18	1.2	2	3	5	8	11	18	27	43	70	110	0.18	0.27	0.43	0.7	1.1	1.8	2.7
18	30	1.5	2.5	4	6	9	13	21	33	52	84	130	0.21	0.33	0.52	0.84	1.3	2.1	3.3
30	50	1.5	2.5	4	7	11	16	25	39	62	100	160	0.25	0.39	0.62	1	1.6	2.5	3.9
50	80	2	3	5	8	13	19	30	46	74	120	190	0.3	0.46	0.74	1.2	1.9	3	4.6
80	120	2.5	4	6	10	15	22	35	54	87	140	220	0.35	0.54	0.87	1.4	2.2	3.5	5.4
120	180	3.5	5	8	12	18	25	40	63	100	160	250	0.4	0.63	1	1.6	2.5	4	6.3
180	250	4.5	7	10	14	20	29	46	72	115	185	290	0.46	0.72	1.15	1.85	2.9	4.6	7.2
250	315	6	8	12	16	23	32	52	81	130	210	320	0.52	0.81	1.3	2.1	3.2	5.2	8.1
315	400	7	9	13	18	25	36	57	89	140	230	360	0.57	0.89	1.4	2.3	3.6	5.7	8.9
400	500	8	10	15	20	27	40	63	97	155	250	400	0.63	0.97	1.55	2.5	4	6.3	9.7
500	630	9	11	16	22	32	44	70	110	175	280	440	0.7	1.1	1.75	2.8	4.4	7	11
630	800	10	13	18	25	36	50	80	125	200	320	500	0.8	1.25	2	3.2	5	8	12.5
800	1000	11	15	21	28	40	56	90	140	230	360	560	0.9	1.4	2.3	3.6	5.6	9	14
1000	1250	13	18	24	33	47	66	105	165	260	420	660	1.05	1.65	2.6	4.2	6.6	10.5	16.5
1250	1600	15	21	29	39	55	78	125	195	310	500	780	1.25	1.95	3.1	5	7.8	12.5	19.5
1600	2000	18	25	35	46	65	92	150	230	370	600	920	1.5	2.3	3.7	6	9.2	15	23
2000	2500	22	30	41	55	78	110	175	280	440	700	1100	1.75	2.8	4.4	7	11	17.5	28
2500	3150	26	36	50	68	96	135	210	330	540	860	1350	2.1	3.3	5.4	8.6	13.5	21	33

Note:

From IT1 to IT5, the standard tolerance with basic dimension more than 500 mm is as trial.
When the basic dimension 1 mm, the tolerances from IT4 to IT8 are invalid.

Bemerkung:

Für die Standardt Toleranzen IT1 bis IT5 bei Durchmesser über 500 mm ist eine Anpassung notwendig. Bei Basis abmessungen unter 1 mm ist das Toleranzfeld IT4 bis IT8 ungültig.

The shaft lower deviation(ei) and upper deviation (es) can be obtained by basic tolerance and standard tolerance (IT) of shaft.

Toleranz Einheitswelle: Die geringste Abweichung (ei) und die größte Abweichung (es) sind als Basis bzw. Standard-Toleranzen (IT) in der Tabelle angegeben.

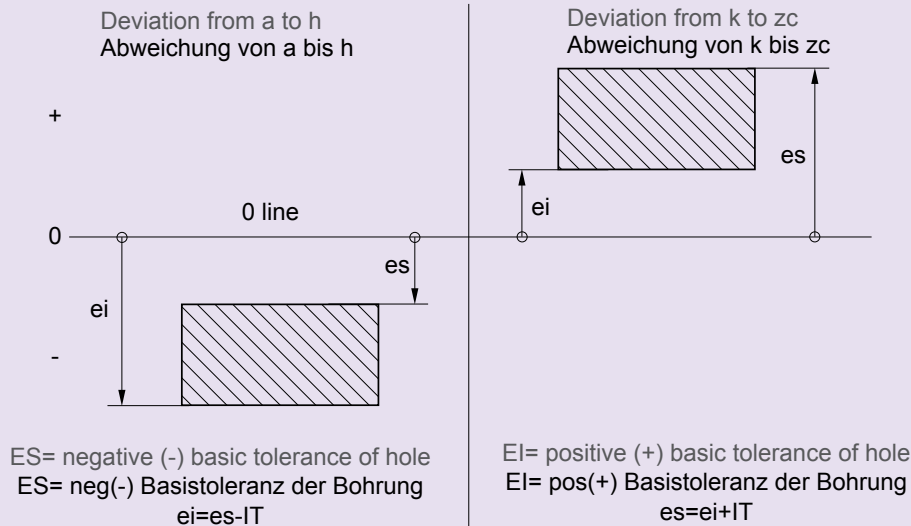

The hole lower deviation(EI) and upper deviation (ES) can be obtained by basic tolerance and standard tolerance (IT) of hole.

Toleranz Einheitsbohrung: Die geringste Abweichung (EI) und die größte Abweichung (ES) sind als Basis bzw. Standard-Toleranzen (IT)- Bohrung in der Tabelle angegeben.

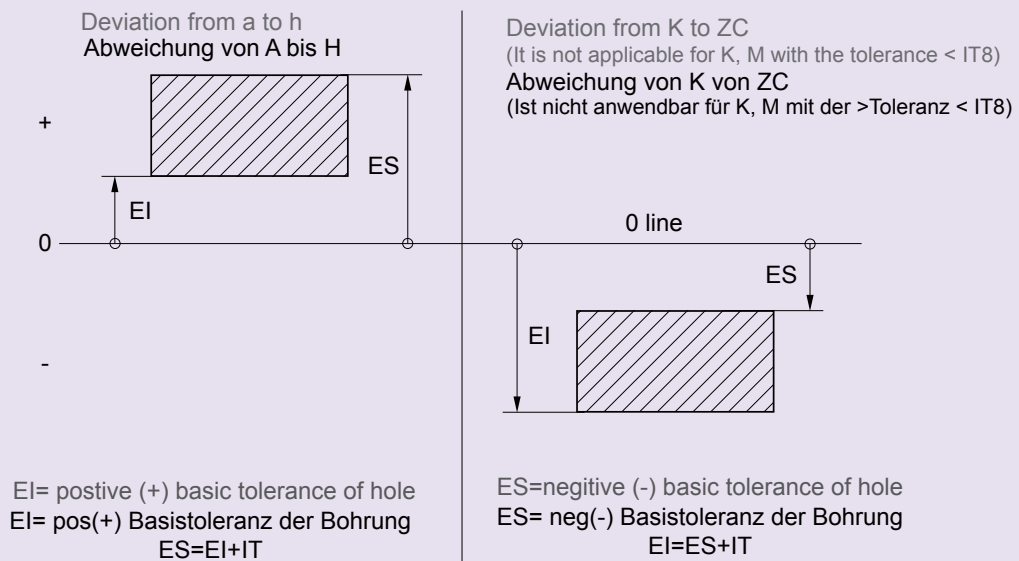

For example: for a hole with diameter 3 mm and tolerance H7, we can find that the lower deviation $EI=0$ in relation to H7 from the basic tolerance table, and the standard tolerance $IT=10\mu\text{m}$ corresponding to H7, thus the upper deviation $ES=EI+IT=10\mu\text{m}$. Therefore the hole fitting

dimension is $\varnothing 3_0^{+0.01}$ mm.

Beispiel: Bei einem Durchmesser von 3mm und einer Toleranz H7 ist bei der Basis Toleranz H7 $EI=0$ bei der Standard-Toleranz H7 ist es $IT=10\mu\text{m}$. Die größte Abweichung ist demzufolge: $ES=EI+IT=10\mu\text{m}$.

Die Bohrungstoleranz ist bei einem $\varnothing 3_0^{+0.01}$ mm.

General Technical Inform - Allgemeine Technische Info

- Basic deviations value of shaft
- Basistoleranzwerte Einheitswelle

Diameter Durchmesser Ø (mm)		Basic deviation value · Basistoleranzwerte											
		Upper deviation es · Höchstabweichung											
		Standard tolerance class · Standard-Toleranzklasse											
>	≤	a	b	c	cd	d	e	ef	f	fg	g	h	js
---	3	-270	-140	-60	-34	-20	-14	-10	-6	-4	-2	0	Die Formel für die Abweichung $\pm \frac{IT_n}{2}$, ITn ist der IT Wert entsprechend zu "n" zugeordnet.
3	6	-270	-140	-70	-46	-30	-20	-14	-10	-6	-4	0	
6	10	-280	-150	-80	-56	-40	-25	-18	-13	-8	-5	0	
10	14	-290	-150	-95		-50	-32		-16		-6	0	
14	18												
18	24	-300	-160	-110		-65	-40		-20		-7	0	
24	30												
30	40	-310	-170	-120		-80	-50		-25		-9	0	
40	50	-320	-180	-130									
50	65	-340	-190	-140		-100	-60		-30		-10	0	
65	80	-360	-200	-150									
80	100	-380	-220	-170		-120	-72		-36		-12	0	
100	120	-410	-240	-180									
120	140	-460	-260	-200									
140	160	-520	-280	-210		-145	-85		-43		-14	0	
160	180	-580	-310	-230									
180	200	-660	-340	-240									
200	225	-740	-380	-260		-170	-100		-50		-15	0	
225	250	-820	-420	-280									
250	280	-920	-480	-300		-190	-110		-56		-17	0	
280	315	-1050	-540	-330									
315	355	-1200	-600	-360		-210	-125		-62		-18	0	
355	400	-1350	-680	-400									
400	450	-1500	-760	-440		-230	-135		-68		-20	0	
450	500	-1650	-840	-480									
500	560					-260	-145		-76		-22	0	
560	630												
630	710					-290	-160		-80		-24	0	
710	800												
800	900					-320	-170		-86		-26	0	
900	1000												
1000	1120					-350	-195		-98		-28	0	
1120	1250												
1250	1400					-390	-220		-110		-30	0	
1400	1600												
1600	1800					-430	-240		-120		-32	0	
1800	2000												
2000	2240					-480	-260		-130		-34	0	
2240	2500												
2500	2800					-520	-290		-145		-38	0	
2800	3150												

Note: 1. If basic dimension ≤ 1mm, the basic deviation a and b are not adopted.

Bemerkungen: 1. Bei Abmessungen ≤ 1mm, sind die Basisabweichungen a und b nicht berücksichtigt.

D

Technical Info
Technische Info

General Technical Inform ▪ Allgemeine Technische Info

µm

Basic deviation value · Basistoleranzwerte Einheitswelle																			
Lower deviation ei · geringste Abweichung																			
IT5 IT6	IT7	IT8	IT4 IT7	≤IT3 >IT7	Standard tolerance class · Standard-Toleranzklasse														
j			k		m	n	p	r	s	t	u	v	x	y	z	zn	zb	zc	
-2	-4	-6	0	0	+2	+4	+6	+10	+14		+18		+20		+26	+32	+40	+60	
-2	-4		+1	0	+4	+8	+12	+15	+19		+23		+28		+35	+42	+50	+80	
-2	-5		+1	0	+6	+10	+15	+19	+23		+28		+34		+42	+52	+67	+97	
-3	-6		+1	0	+7	+12	+18	+23	+28		+33		+40		+50	+64	+90	+130	
												+39	+45		+60	+77	+108	+150	
-4	-8		+2	0	+8	+15	+22	+28	+35		+41	+47	+54	+63	+73	+98	+136	+188	
											+41	+48	+55	+64	+75	+88	+118	+160	+218
-5	-10		+2	0	+9	+17	+26	+34	+43		+48	+60	+68	+80	+94	+112	+148	+200	+274
											+54	+70	+81	+97	+114	+136	+180	+242	+325
-7	-12		+2	0	+11	+20	+32	+41	+53	+66	+87	+102	+122	+144	+172	+226	+300	+405	
								+43	+59	+75	+102	+120	+146	+174	+210	+274	+360	+480	
-9	-15		+3	0	+13	+23	+37	+51	+71	+91	+124	+146	+178	+214	+258	+335	+445	+585	
								+54	+79	+104	+144	+172	+210	+254	+310	+400	+525	+690	
-11	-18		+3	0	+15	+27	+43	+63	+92	+122	+170	+202	+248	+300	+365	+470	+620	+800	
								+65	+100	+134	+190	+228	+280	+340	+415	+535	+700	+900	
								+68	+108	+146	+210	+252	+310	+380	+465	+600	+780	+1000	
-13	-21		+4	0	+17	+31	+50	+77	+122	+166	+236	+284	+350	+425	+520	+670	+880	+1150	
								+80	+130	+180	+258	+310	+385	+470	+575	+740	+960	+1250	
								+84	+140	+196	+284	+340	+425	+520	+640	+820	+1050	+1350	
-16	-26		+4	0	+20	+34	+56	+94	+158	+218	+315	+385	+475	+580	+710	+920	+1200	+1550	
								+98	+170	+240	+350	+425	+525	+650	+790	+1000	+1300	+1700	
-18	-28		+4	0	+21	+37	+62	+108	+190	+268	+390	+475	+590	+730	+900	+1150	+1500	+1900	
								+114	+208	+294	+435	+530	+660	+820	+1000	+1300	+1650	+2100	
-20	-32		+5	0	+23	+40	+68	+126	+232	+330	+490	+595	+740	+920	+1100	+1450	+1850	+2400	
								+132	+252	+360	+540	+660	+820	+1000	+1250	+1600	+2100	+2600	
			0	0	+26	+44	+78	+150	+280	+400	+600								
								+155	+310	+450	+660								
			0	0	+30	+50	+88	+175	+340	+500	+740								
								+185	+380	+560	+840								
			0	0	+34	+56	+100	+210	+430	+620	+940								
								+220	+470	+680	+1050								
			0	0	+40	+66	+120	+250	+520	+780	+1150								
								+260	+580	+840	+1300								
			0	0	+48	+78	+140	+300	+640	+960	+1450								
								+330	+720	+1050	+1600								
			0	0	+58	+92	+170	+370	+820	+1200	+1850								
								+400	+920	+1350	+2000								
			0	0	+68	+110	+195	+440	+1000	+1500	+2300								
								+460	+1100	+1650	+2500								
			0	0	+76	+135	+240	+550	+1250	+1900	+2900								
								+580	+1400	+2100	+3200								



Technical Info
Technische Info

General Technical Inform - Allgemeine Technische Info

- Basic deviations value of hole
- Basistoleranzwerte Einheitsbohrung

Diameter Durchmesser Ø (mm)		Basic deviation value · Basis-Toleranzwerte Einheitswelle																					
		Lower deviation EI · geringste Abweichung EI											Upper deviation ES · Höchstabweichung ES										
		Standard tolerance class · Standard-Toleranzklasse											IT6	IT7	IT8	≤IT8	>IT8	≤IT8	>IT8	≤IT8	>IT8	≤IT7	
>	≤	A	B	C	CD	D	E	EF	F	FG	G	H	JS	J		K		M		N		P to ZC	
---	3	+270	+140	+60	+34	+20	+14	+10	+6	+4	+2	0	In the formula Deviation = ± $\frac{IT_n}{2}$, ITn is the IT value corresponding to 'n'. Die Formel für die Abweichung = ± $\frac{IT_n}{2}$, ITn ist der IT Wert entsprechend zu 'n' zugeordnet.	+2	+4	+6	0	0	-2	-2	-4	-4	Wenn IT ≥ IT7, wird der Δ wert zuaddiert. If IT ≥ IT7, add a Δ value to the relevant value
3	6	+270	+140	+70	+46	+30	+20	+14	+10	+6	+4	0		+5	+6	+10	-1+Δ		-4+Δ	-4	-8+Δ	0	
6	10	+280	+150	+80	+56	+40	+25	+18	+13	+8	+5	0		+5	+8	+12	-1+Δ		-6+Δ	-6	-10+Δ	0	
10	14	+290	+150	+95		+50	+32		+16		+6	0		+6	+10	+15	-1+Δ		-7+Δ	-7	-12+Δ	0	
14	18																						
18	24	+300	+160	+110		+65	+40		+20		+7	0		+8	+12	+20	-2+Δ		-8+Δ	-8	-15+Δ	0	
24	30																						
30	40	+310	+170	+120		+80	+50		+25		+9	0		+10	+14	+24	-2+Δ		-9+Δ	-9	-17+Δ	0	
40	50	+320	+180	+130																			
50	65	+340	+190	+140		+100	+60		+30		+10	0		+13	+18	+28	-2+Δ		-11+Δ	-11	-20+Δ	0	
65	80	+360	+200	+150																			
80	100	+380	+220	+170		+120	+72		+36		+12	0		+16	+22	+34	-3+Δ		-13+Δ	-13	-23+Δ	0	
100	120	+410	+240	+180																			
120	140	+460	+260	+200		+145	+85		+43		+14	0		+18	+26	+41	-3+Δ		-15+Δ	-15	-27+Δ	0	
140	160	+520	+280	+210																			
160	180	+580	+310	+230		+170	+100		+50		+15	0		+22	+30	+47	-4+Δ		-17+Δ	-17	-31+Δ	0	
180	200	+660	+340	+240																			
200	225	+740	+380	+260		+190	+110		+56		+17	0		+25	+36	+55	-4+Δ		-20+Δ	-20	-34+Δ	0	
225	260	+820	+420	+280																			
260	280	+920	+480	+300		+210	+125		+62		+18	0		+29	+39	+60	-4+Δ		-21+Δ	-21	-37+Δ	0	
315	355	+1200	+600	+360																			
355	400	+1350	+680	+400		+230	+135		+68		+20	0		+33	+43	+66	-5+Δ		-23+Δ	-23	-40+Δ	0	
400	450	+1500	+760	+440																			
450	500	+1650	+840	+480		+260	+145		+76		+22	0							0		-26	-44	
500	560																						
560	630					+290	+160		+80		+24	0							0		-30	-50	
630	710																						
710	800					+320	+170		+86		+26	0							0		-34	-56	
800	900																						
900	1000					+350	+195		+98		+28	0							0		-40	-66	
1000	1120																						
1120	1250					+390	+220		+110		+30	0							0		-48	-78	
1250	1400																						
1400	1600					+430	+240		+120		+32	0						0		-58	-92		
1600	1800																						
1800	2000					+480	+260		+130		+34	0						0		-68	-110		
2000	2240																						
2240	2500					+520	+290		+145		+38	0						0		-76	-135		
2500	2800																						
2800	3150																						

D

Technical Info
Technische Info

General Technical Inform ▪ Allgemeine Technische Info

µm

Basic deviation value · Basis-Toleranzwerte Einheitswelle												Δ					
Upper deviation ES · Höchstabweichung ES																	
Standard tolerance class >IT7 · Standard-Toleranzklasse > IT7												Standard tolerance class Standard-Toleranzklasse					
P	R	S	T	U	V	X	Y	Z	ZA	ZB	ZC	IT3	IT4	IT5	IT6	IT7	IT8
-6	-10	-14		-18		-20		-26	-32	-40	-60	0	0	0	0	0	0
-12	-15	-19		-23		-28		-35	-42	-50	-80	1	1.5	1	3	4	6
-15	-19	-23		-28		-34		-42	-52	-67	-97	1	1.5	2	3	6	7
-18	-23	-28		-33		-40		-50	-64	-90	-130	1	2	3	3	7	9
					-39	-45		-60	-77	-108	-150						
-22	-28	-35		-41	-47	-54	-63	-73	-98	-136	-188	1.5	2	3	4	8	12
			-41	-48	-55	-64	-75	-88	-118	-160	-218						
-26	-34	-43	-48	-60	-68	-80	-94	-112	-148	-200	-274	1.5	3	4	5	9	14
			-54	-70	-81	-97	-114	-136	-180	-242	-325						
-32	-41	-53	-66	-87	-102	-122	-144	-172	-226	-300	-405	2	3	5	6	11	16
	-43	-59	-75	-102	-120	-146	-174	-210	-274	-360	-480						
-37	-51	-71	-91	-124	-146	-178	-214	-258	-335	-445	-585	2	4	5	7	13	19
	-54	-79	-104	-144	-172	-210	-254	-310	-400	-525	-690						
-43	-63	-92	-122	-170	-202	-248	-300	-365	-470	-620	-800	3	4	6	7	15	23
	-65	-100	-134	-190	-228	-280	-340	-415	-535	-700	-900						
	-68	-108	-146	-210	-252	-310	-380	-465	-600	-780	-1000						
-50	-77	-122	-166	-236	-284	-350	-425	-520	-670	-880	-1150	3	4	6	9	17	26
	-80	-130	-180	-258	-310	-385	-470	-575	-740	-960	-1250						
	-84	-140	-196	-284	-340	-425	-520	-640	-820	-1050	-1350						
-56	-94	-158	-218	-315	-385	-475	-580	-710	-920	-1200	-1550	4	4	7	9	20	29
	-98	-170	-240	-350	-425	-525	-650	-790	-1000	-1300	-1700						
-62	-108	-190	-268	-390	-475	-590	-730	-900	-1150	-1500	-1900	4	5	7	11	21	32
	-114	-208	-294	-435	-530	-660	-820	-1000	-1300	-1650	-2100						
-68	-126	-232	-330	-490	-595	-740	-920	-1100	-1450	-1850	-2400	5	5	7	13	23	34
	-132	-252	-360	-540	-660	-820	-1000	-1250	-1600	-2100	-2600						
-78	-150	-280	-400	-600													
	-155	-310	-450	-660													
-88	-175	-340	-500	-740													
	-185	-380	-560	-840													
100	-210 -220	-430 -470	-620 -680	-940 -1050													
-120	-250 -260	-520 -580	-780 -840	-1150 -1300													
-140	-300 -330	-640 -720	-960 -1050	-1450 -1600													
-170	-370	-820	-1200	-1850													
	-400	-920	-1350	-2000													
-195	-440 -460	-1000 -1100	-1500 -1650	-2300 -2500													
-240	-550 -580	-1250 -1400	-1900 -2100	-2900 -3200													

D

Technical Info
Technische Info

Hardness reference table (conversion of hardness and strength for ferrous metal) Härte Vergleichstabelle (Konversationstabelle von Härte und Zugfestigkeit für Stahl)

Hardness · Härte				Tensile strength Zugfestigkeit N/mm ²	Hardness · Härte				Tensile strength Zugfestigkeit N/mm ²
Rockwell hardness · Härte		Vickers hardn. · Härte	Brinell hardn. · Härte		Rockwell hardness · Härte		Vickers hardn. · Härte	Brinell hardn. · Härte	
HRC	HRA	HV	HB		HRC	HRA	HV	HB	
70.0	86.6	1037	—	—	51.0	76.3	525	501	1780
69.5	86.3	1017	—	—	50.5	76.1	517	494	1750
69.0	86.1	997	—	—	50.0	75.8	509	488	1720
68.5	85.8	978	—	—	49.5	75.5	501	481	1690
68.0	85.5	959	—	—	49.0	75.3	493	474	1660
67.5	85.2	941	—	—	48.5	75.0	485	468	1630
67.0	85.0	923	—	—	48.0	74.7	478	461	1605
66.5	84.7	906	—	—	47.5	74.5	470	455	1575
66.0	84.4	889	—	—	47.0	74.2	463	449	1550
65.5	84.1	872	—	—	46.5	73.9	456	442	1525
65.0	83.9	856	—	—	46.0	73.7	449	436	1500
64.5	83.6	840	—	—	45.5	73.4	443	430	1475
64.0	83.3	825	—	—	45.0	73.2	436	424	1450
63.5	83.1	810	—	—	44.5	72.9	429	418	1430
63.0	82.8	795	—	—	44.0	72.6	423	413	1405
62.5	82.5	780	—	—	43.5	72.4	417	407	1385
62.0	82.2	766	—	—	43.0	72.1	411	401	1360
61.5	82.0	752	—	—	42.5	71.8	405	396	1340
61.0	81.7	739	—	—	42.0	71.6	399	391	1320
60.5	81.4	726	—	—	41.5	71.3	393	385	1300
60.0	81.2	713	—	2555	41.0	71.1	388	380	1280
59.5	80.9	700	—	2500	40.0	70.8	382	375	1260
59.0	80.6	688	—	2450	40.0	70.5	377	370	1245
58.5	80.3	676	—	2395	39.5	70.3	372	365	1225
58.0	80.1	664	—	2345	39.0	70.0	367	360	1210
57.5	79.8	653	—	2295	38.5	—	362	355	1190
57.0	79.5	642	—	2250	38.0	—	357	350	1175
56.5	79.3	631	—	2205	37.5	—	352	345	1160
56.0	79.0	620	—	2160	37.0	—	347	341	1140
55.5	78.7	609	—	2115	36.5	—	342	336	1125
55.0	78.5	599	—	2075	36.0	—	338	332	1110
54.5	78.2	589	—	2035	35.5	—	333	327	1095
54.0	77.9	579	—	1995	35.0	—	329	323	1080
53.5	77.7	570	—	1955	34.5	—	324	318	1065
53.0	77.4	561	—	1920	34.0	—	320	314	1050
52.5	77.1	551	—	1885	33.5	—	316	310	1035
52.0	76.9	543	—	1850	33.0	—	312	306	1020
51.5	76.6	534	—	1815	32.5	—	308	302	1010

D

Technical Info
Technische Info

Hardness reference table (conversion of hardness and strength for ferrous metal) Härte Vergleichstabelle (Konversationstabelle von Härte und Zugfestigkeit für Stahl)

Hardness · Härte				Tensile strength Zugfestigkeit N/mm ²	Hardness · Härte				Tensile strength Zugfestigkeit N/mm ²
Rockwell hardness · Härte		Vickers hardn. · Härte	Brinell hardn. · Härte		Rockwell hardness · Härte		Vickers hardn. · Härte	Brinell hardn. · Härte	
HRC	HRA	HV	HB		HRC	HRA	HV	HB	
32.0	—	304	298	995	24.0	—	249	245	820
31.5	—	300	294	980	23.5	—	246	242	810
31.0	—	296	291	970	23.0	—	243	240	800
30.5	—	292	287	960	22.5	—	240	237	790
30.0	—	289	283	950	22.0	—	237	234	785
29.5	—	285	280	935	21.5	—	234	232	775
29.0	—	281	276	920	21.0	—	231	229	765
28.5	—	278	273	910	20.5	—	229	227	760
28.0	—	274	269	900	20.0	—	226	225	750
27.5	—	271	266	890	19.5	—	223	222	745
27.0	—	268	263	880	19.0	—	221	220	735
26.5	—	264	260	870	18.5	—	218	218	730
26.0	—	261	257	860	18.0	—	216	216	725
25.5	—	258	254	850	17.5	—	214	214	715
25.0	—	255	251	835	17.0	—	211	211	710
24.5	—	252	248	830					

Note: The conversion values for steel in the table are commonly applicable for the steels with carbon from low to high.
Bemerkung: Die in der Tabelle aufgeführten Werte sind für Kohlenstoffstahl anwendbar.

General Technical Inform - Allgemeine Technische Info

Comparison table for turning inserts chip breaker - Übersichtstabelle der WSP-Spanbrecher



Technical Info
Technische Info

ISO		Comparison table for turning inserts chip breaker Übersichtstabelle der WSP-Spanbrecher																								
		Application Anwendung	ZCC-CT		Sandvik		Seco		Kennametal		ISCAR		Walter		Mitsubishi		Sumitomo		Tungaloy		Kyocera		Korloy		Ingersoll Tague Tec	
P	Steel · Stahl	Neg	Pos	Neg	Pos	Neg	Pos	Neg	Pos	Neg	Pos	Neg	Pos	Neg	Pos	Neg	Pos	Neg	Pos	Neg	Pos	Neg	Pos	Neg	Pos	
				WG		WF WL	WF WK	W-MF2	W-F1	FW-MW	FW-MW	WF	NF	PF	SW	FW	NLU-W	NLU-W	ASW	WP	VW LW				WS	
		DF EF	SF HF	PF UF	PF UF	FF1 MF1	FF1 F1	11 UF	11 UF	SF	NF3 NS6	PF4 PF5	FH FS	FJ FV	NSE NSU NLU NFA NFL	TF TS 17	DP GP VF	DP GP VF	VG VF VL				FG FC VF			FASA FG
		DM EM	HM	PM QM	PM UM	MF2	F2	MF	MF	NF TF SM 14 16 17 19	NS6	SH SA MV	SW SV MV	NSU NSC NSK	TS TM AS	HQ CQ CJ	HQ CQ CJ	VQ VC VB				WTML				WT
		DM PM	HR	PM QM	PR UR	M3 MF3	F2	MN	MF	GN PP NR 17 19	NM4 NM6	MV MZ MA	MV MW	NGE NGU NUX	TM DM	GS CS HQ XQ HS PS GK G	GS CS HQ XQ HS PS GK G	VM				PC MC MT MG MF				PC MT PMR
				WR WM	WM	W-M3 W-R4 W-R7	W-F2	MW RW	MW	WG	NM	PM	MW	NGU-W			WQ									
		DR		PR QR	31	M5 MR5 MR7		RP UN RN		TNM GN 19	NM9	GH MAT MT		NMU NMX	TH TR TU	PT GT HT	G St-form						RT			
		HDR 31HPR DR LR		HR QR		R8 RR9 -56 -57 -UX		RH RM RP		NM	NR6 NR8	HA HZ HH HV HX		NMP NHG NHP NHU NHW		HX						HT HD HY HZ RX RH				CMX
		WG		WF WL	WF WK	W-MF2	W-F1	FW-MW	FW-MW	WF		PF	SW	FW	NLU-W											
		EF DF	EF HF	MF UF	MF UF	FF1 F2 MF1	F1	FF FP	11 UF LF	NF VL PF SM NF4	PF4 PF5	FS	FJ FV	NSU NLU	SS	GU							VF			FG
		EF EM	EF EM HF HM	MF MM	MF MM UM	MF3	F2	FP	MF	PP TF 14 16 17 19	NM4	SH MS MV	SW SV MV	NSU NEX NUP	SS SM	MS	CK DP GP VF XP						HMP			
		EM DM	EM HM	MM	MM UM	R6 56	F2	MP	HP	PP TF 17 19	NM4 NR4	MES MH	MV MW	NGU	SAS	MS	HQ XQ GK G									MT PMR WT
				WR WM	WM	W-M3		MW RW	MW	WG		PM	MW	NGU -W												
		ER DR	HR	MR QR	MR	R7 R8		MP -P		HTW NR 19	NR4	GH HZ		NMU NMX NHG												CMX
		ER DR HDR LR		HR QR		-56		RP		NM				NMP NHG NHP NHU NHW												

M Stainless Steel · Rostfreier Stahl

General Technical Inform - Allgemeine Technische Info

Comparison table for turning inserts chip breaker - Übersichtstabelle der WSP-Spanbrecher

Comparison table for turning inserts chip breaker · Übersichtstabelle der WSP-Spanbrecher																										
ISO	Application Anwendung	ZCC-CT		Sandvik		Seco		Kennametal		ISCAR		Walter		Mitsubishi		Sumitomo		Tungaloy		Kyocera		Korloy		Ingersoll Tague Tec		
		Neg	Pos	Neg	Pos	Neg	Pos	Neg	Pos	Neg	Pos	Neg	Pos	Neg	Pos	Neg	Pos	Neg	Pos	Neg	Pos	Neg	Pos	Neg	Pos	
K Cast IronGuss	Wiper-finishing Wiper-Schichten	WG		WF WM	WF	W-MF2	W-F1	FW/MW	FW/MW	WF							NLU-W	NLU-W								
	Finishing · Schichten	DF	HF	KF	KF	F1	F1	FF FN	11 UF LF	NF SM	14 19	PS5				NSU	NLU	C				VM				
	Semi-finishing Schichten-Mittlere Bearbeitung	PM	HM	KF KM	KF KM	M3	F2	FN	MF	GN	14 19	NM5	GH		NUX NGU	NSU		C Stand- form	CM			B25	HMP			
	Medium machining light roughing Mittlere Bearbeitung-leichte Schruppbearbeitung	DR	HM HR	KM QM	KM	M3	F2	UN	HP	GN NR		NM6	PM5		NUZ NGU NMU	NMU		GC ZS	CM			VK GR	C25	MT MG	MT PMR WT	
	Wiper medium					W-M3 W-R4 W-R7		MW	MW	WG		NM	PM		NGU-W											
	Roughing Schruppbearbeitung	DR	HR	KR QR	KR UR	M5					NR		NR6	GH		NMU		ZS				MA		RT	CMX	
	Finishing · Schichten		LC		AL				LF		NF		PM2													
	Semi-finishing Schichten-Mittlere Bearbeitung		LC		AL		AL	GP		NF PP	AS						NAG					HA	AK		FL SA	
	Medium machining-light roughing Mittlere Bearbeitung- leichtes Schruppbearbeitung		LH		AL		AL	GG-FS MS	HP		NMS													AR		
	S Heat resist. super alloys & Ti- alloys Warmt. Legl. & Ti-Legierung	Finishing · Schichten	NF EF	NF	NGP	MF	MF1		FS	GT-HP	SF PF	PF SM	PF4	FJ		NSU							VP1			
Semi-finishing Schichten-Mittlere Bearbeitung		NF NM EM	NF	23	MM	MF1 M1		FS MS	GT-MF	SF PF	PF SM	PF5	MJ		NEX NUP							VP2	AK			
Medium machining-light roughing Mittlere Bearbeitung- leichte Schruppen				MF	MM UM	M1		MS	MT-LF	PP TF			MS		NMU							VP3	HMP	SU		
Roughing Schruppbearbeitung		ER		SR		MR3 MR4		RP		TF HTW NR			GJ									VM				



General Technical Inform - Allgemeine Technische Info

Coated Cemeted Carbide CVD - beschichtetes Hartmetall CVD

ISO	ZCC-CT	Sandvik	Kennametal	Sumitomo	Mitsubishi	Toshiba Tungaloy	Kyocera	Walter	Iscar	SECO	Korloy	Ingersoll Tague Tec	Widia
P Steel · Stahl	P01-05	GC4205 GC4305	KCP05 KC9105	AC805P	UE6005 UE6105	T9005 T9105	CA5505	WPP01 WPP05	IC8150 IC9150 IC428	TP0500 TP0501			
	P10-15	GC4315 GC4215	KCP10 KC9110	AC810P AC700G	UC6110 MY5015	T9015 T9115	CA510 CA5515 CA510	WPP10 WPP10S	IC8150 IC8250 IC9150 IC9250 IC9015	TP1500 TP1501	NC3010	TT8115 TT8125	WP15CT
	P20-25	GC4325 GC4225 GC4025	KCP25 KC9125	AC820P AC8020P AC900G AC2000	UE6020 MC6025	T9025 T9125	CA5525 CA525 CR9025	WPP20 WPP20S	IC8150 IC8250 IC9250 IC9025	TP2501 TP2500 TP200	NC3220 NC3120	TT8125 TT3500	WP25CT
P30-35	GC4335 GC4235 GC4035	KCP30 KC8050	AC830P AC3000	UE6035 UE6400	T903 T9135	CA530 CA5535 CA535	WPP30 WPP30S	IC8250 IC8350 IC9350 IC9025	TP3500	NC3030 NC5330 NC500H	TT5100 TT8135	WP35CT	
M10	YBM151 YBM153	GC2015 GC1515	KCM15	AC610M	MC7015	T9115		IC8250 IC9250 IC6015			TT9215	WM15CT	
M20	YBM253 YBM251	GC2015 GC2025	KCM25 KC9225	AC610M AC630M	US7020 MC7015 MC7025	T6020 T6120 T9125	CA6515	WAM20	IC8250 IC9350 IC9025 IC6025	TM 2000 TP200 TP2500	NC9025	TT5100 TT9225	WM25CT
M30	YBM351 YBM253	GC2025 GC2035	KCM25 KCM35 KC9225	AC630M AC6030M AC830P AC3000	US735 US7025	T6030 T6130	CA6525	WAM30	IC8350 IC9350 IC9025	TP3500 TM4000		TT5100 TT7100 TT9235	WM35CT
M40	YBM351	GC2035	KCM35 KC9240 KC9245	AC630M AC6030M AC830P AC3000	US735	T6030 T6130	CA6525		IC6025 IC9350	TP40		TT5100 TT7100 TT9235	
K01-05	YBD052	GC3005 GC3205	KCK05	AC405K AC410K	UC5005 UC5105	T5105	CA4505		IC5005 IC9007		NC6205	TT1300 TT7005	WK05CT
K10-15	YB7315 YBD102 YBD152 YBD152C	GC3215	KCK15 KC9315	AC410K AC415K AC420K AC700G	MC5015 UC5115 MY5015	T5105 T5115	CA4010 CA4515 CA4115	WAK10 WAK10S	IC9015 IC9007 IC8150 IC5010 IC428 IC4028 IC9150	TK1001 TK1000	NC6210	TT1300 TT7310 T7015	
K20-25	YB7315 YBD152 YBD152C	GC3225	KCK20 KC9320	AC420K AC900G	MC5015 UE6110 MY5015	T5125 T9125	CA4125	WAK20 WKK20S	IC5010 IC428 IC4028 C9150	TK2000 TK2001	NC5330		WK20CT



Technical Info
Technische Info

General Technical Inform ▪ Allgemeine Technische Info

Coated Cemeted Carbide PVD · beschichtetes Hartmetall PVD

ISO	ZCC-CT	Sandvik	Kennametal	Sumitomo	Mitsubishi	Toshiba Tunggaloy	Kyocera	Walter	Iscar	SECO	Korloy	Ingersoll Tague Tec	Widia
P Steel · Stahl	P01-05	GC1105					PR1005						
	P10-15	GC1515 GC1115 GC1025	KC5010 KC5510 KC7215 KC7315	AC510U	VP10MF VP15TF	AH710	PR930 PR1005 PR930 PR115	WSM10 WXN10	IC520N IC507 IC570 IC807 IC907 IC908				
	P20-25	GC1515 GC1125 GC1025	KC5025 KC5525 KU25T	AC520U	VP20RT VP20MF	AH725 AH120	PR930 PR1025 PR1225	WSM20 WMP20S WSM21	IC228 IC250 IC308 IC328 IC350 IC354 IC507 IC807 IC808 IC907 IC908 IC928 IC1008 IC1028 IC3028	CP200 CP250 TP2000 TS2500		TT8020 TT9020	
P30-35	GC1125 GC2035	KC7335	AC530U		SH730 J740 GH130 AH740	PR660	WSM30	IC228 IC250 IC328 IC330 IC354 IC528 IC1008 IC1028 IC3028	CP500	PC5300			
M Stainless Steel Rostfreier Stahl	M10	GC1105 GC1115 GC1025 GC1125 GC1515	KCU10 KC5010 KC5510 KC6005 KC6015	EH10Z AC510U AC530U	VP10MF	AH710	PR915 PR1005	WSM10	IC330 IC354 IC507 IC520 IC570 IC807 IC1028 IC3028	CP500 TS2000	PC8110	TT5080	WS10PT
	M20	GC1025 GC1125	KC501 KC25	AC520U AC530U	VP10RT VP15TF VP20RT VP20MF	AH120 AH725 SH730 AH710 AH630 GH330	PR1025 PR1125 PR1225	WSM10 WMP20S WSM20 WSM21	IC228 IC250 IC354 IC808 IC908 IC1008 IC1028 IC3028	TS2000 TS2500 CP200 CP250		TT8020 TT9020 TT9080	WS25PT
	M30	GC2035	KC5025 KC25		VP10RT VP15TF VP20RT VP20MF MP7035	AH12 AH725 SH730 AH710 AH630 GH330 J740	PR1025 PR1125	WSM20 WSM21 WSM30	IC228 IC250 IC328 IC330 IC1008 IC1028 IC3028	CP500 TS2500	PC5300 PC9030		
S Heat resist. super all. & Ti- alloys Warmt. Legl. & Ti- Legierung	S05	S05F		MP9005	MP9005	AH905			IC507 IC907				
	S10	GC1105 GC1115	KG5010 KCU10 KC5510 KCS10	AC510U EH510Z	MP9015 VP10RT	AH905 SH730 AH110 AH120		WSM10	IC507 IC807 IC808 IC806 IC907	CP200 CP250 TS2000 TS2500	PC8110	TT5080	WS10PT
	S20	GC1025 GC1125 GC1515	KC5010 KCU10 KC5025 KC25 KC5525	AC520U EH520Z	MP9015 MP19015 VP20RT	AH120 AH725	PR1125	WSM20 WSM21 WSM30	IC507 IC807 IC907	CP250 TS2500 CP500	PC5300	TT5080 TT8020 TT9080	WS25PT
S30	YBG302		AC520U	VP15TF	AH725	PR1125	WSM30	IC3028 IC808 IC830			PC5400	TT8020	
N10 Nonferrite Mat. Ne-metalle	YBG101 YBG102 YBG105	GC1515	KC5410				WXN10	IC520					



Technical Info
Technische Info

Cutting material comparison table-Turning - Schneidstoff Vergleichstabelle-Drehen

■ Cermet

ISO	ZCC-CT	Sandvik	Kennametal	Sumitomo	Mitsubishi	Toshiba Tunggaloy	Kyocera	Walter	Iscar	SECO	Korloy	Ingersoll Tague Tec	Widia	
P P01-05 Steel - Stahl		CT5005		T110A T1000A	AP25N VP25N	NS520 AT520 GT520 GT720	TN30 TN6010 PV30 PV7010		IC20N IC520N		CN1000 CC105	CT3000 PV3010		
		CT5015 CT530	KT315 KT125	T1200A T2000Z T1500A T1500Z	NX2525 AP25N VP25N	NS520 NS730 GT730 NS9530 GT9530	TN60 TN6010 PV60 PV6010		IC20N IC520N IC530N	CM TP1020 TP1030 CMP	CN1000 CT10 CN2000 CC115	CT3000 PV3010	TT115	
		GC1525	KT325 KT1120 KT5020	T1200A T2000Z T1500A T1500Z	NX2525 NX3035 AP25N VP25N MP3025	NS530 NS730 GT730 NS9530 GT9530	TN60 TN6020 PV60 PV7020 PV7025		IC20N IC30N IC75T IC520N IC530N	CM TP1020 TP1030 CMP	CN20 CN2000 CC115		TT115	
				T3000Z	MP3025 VP45N	PV7025 PV90		IC75T						
M M10 M20 M30 M40 Stainless Steel Rostfreier Stahl		GC1525	KT125	T110A T1000A T1500Z T2000Z	NX2525 AP25N VP25N	NS520 AT530 GT530 GT720	TN60 TN6020 PV60 PV7020			CM TP1020 TP1030 CMP		CT3000 PV3010	TT115	
		CT5015 CT530	HT2	T110A T1000A T1500Z T2000Z	NX2525 AP25N VP25N	NS530 GT730 NS730	TN90 TN6020 PV90 PV7020 PV7025					CT3000 PV3010	TT115	
				T3000Z										
K K01-05 K10-15 K20-25 Cast Iron Guss				T110A T1000A T2000Z T1500Z	NX2525 AP25N	NS520 GT730 NS730	TN30 TN6010 PV30 PV7005 PV7010				CN1000	CT3000 PV3010		
		CT5015	KT325 KT125	T1200A T1500A T2000Z T1500Z	NX2525 AP25N	NS520 GT730 NS730	TN60 TN6020 PV60 PV7020 PV7025					CN1000	CT3000 PV3010	
		CT5015		T3000Z	NX2525 AP25N									



Cutting material comparison table-Turning · Schneidstoff Vergleichstabelle-Drehen

■ Carbide uncoated · Hartmetall Unbeschichtet

ISO	ZCC-CT	Sandvik	Kennametal	Sumitomo	Mitsubishi	Toshiba Tungaloy	Kyocera	Walter	Iscar	SECO	Korloy	Ingersoll Tague Tec	Widia
N Nonferrierte Mat. Ne-metalle	N01	H10 H13A	KF1	H1		KS05F				883 890			
	N10	H10 H13A	K313 K68 KF1 THM-F	H1	HT110	KS15F	KW10	WK01 WK10	IC20	890 KX HX	H01	K10	THM
	N20	H10 H13A	K313 K68 KF1 THM-F			KS15F	KW15		IC20	KX HX			

CVD milling grades - CVD Fräsen Klasse

Material / Class	ZCC-CT	Sandvik	Kennametal	Sumitomo	Mitsubishi	Toshiba Tungaloy	Kyocera	Walter	Iscar	SECO	Korloy	Ingersoll Tague Tec
P Steel - Stahl	P05	K20W GC4220			F7010							
	P10	K20W GC3040 GC4220 GC4230		ACP100	F7010				IC4100 IC5100	MP1500	NC5330 NCM325	IN6505 IN6520
	P20	GC3040 GC4230		CS3000	FH7020	T3130		WKP25 WKP25S	IC4050 IC4100 IC5100 IC5400	MP1500 MP2500 MS2500 T25M	NC5330 NCM325	IN6505 IN6520 IN7035
	P30	GC2040 GC4240	KC930M KC935M	CS3000	F7030	T3130		WKP35 WKP35S WTP35	IC4050 IC5400	MK3000 T25M T350M	NCM325	IN7035 IN6530
P40	GC2040 GC4240								T350M			IN6530
M Stainless Steel Rostfreier Stahl	M10	GC4230			F7010					MP1500	NCM325 NC5330	IN6520
	M20	GC4230			F7020	T3130			IC4050	MP1500 MP2500 MS2500 T25M	NCM325 NCM335	IN7035 IN6520 IN6505
	M30	GC2040 GC4240	KC930M KC935M		F7030	T3130		WTP35		MP2500 MS2500 T25M T350M	NCM335	IN6530 IN7035 IN6505
	M40	GC2040 GC4240								T350M		IN6530
K Cast Iron - Guss	K05		KCK15		F7010 MC5020				DT7150 IC4100			
	K10	K20W	KCK15	ACK200	F7010 MC5020	T1115		WAK15	DT7150 IC4100 IC4010	MP1500 MK1500	NC5330	IN6520
	K20	K20W		ACK200		T1115		WKP25 WKP25S	DT7150 IC4100	MP1500 MP2500 MS2500 T25M MK1500	NC5330	IN6530 IN6515 IN6520
	K30		KC930M KC935M					WKP35 WKP35S	IC4050	MK3000 MP2500 MS2500		IN6530 IN6515



General Technical Inform ▪ Allgemeine Technische Info

CVD milling grades ▪ CVD Fräsen Klasse

Material / Class	ZCC-CT	Sandvik	Kennametal	Sumitomo	Mitsubishi	Toshiba Tungaloy	Kyocera	Walter	Iscar	SECO	Korloy	Ingersoll Tague Tec
S Super alloys Ti-Legierung	S05									MK3000		
	S10											
	S20									MP2500 MS2500 T25M		IN7035 IN6520
N Nonferrite materials Ne-metalle	S30									MM4500 T350M		
	N05											
	N10											
H Hd-metalle Hd-materiel	N20											
	H05											
	H10											
	H20											



Technical Info
Technische Info

General Technical Inform - Allgemeine Technische Info

PVD milling grades · PVD Fräsen Klasse



Technical Info
Technische Info

Material / Class	ZCC-CT	Sandvik	Kennametal	Sumitomo	Mitsubishi	Toshiba Tungaloy	Kyocera	Walter	Iscar	SECO	Korloy	Ingersoll Tague Tec	
P Steel · Stahl	P05			ACZ120	VP05HT	GH130			IC903			IN2004 IN2006	
	P10	GC1010 GC1025 GC1020	KC522M KC525M KC610M KC643M KC715M	ACZ10M ACZ20W	VP10H	AH120 GH130	PR730 PR1225 PR1525	WHX15 WHH15 WXM15	IC903 IC950 IC1008	F15M			
	P20	GC1020 GC1025 GC1010 GC2030	KC522M KC525M KC643M KC715M KC725M	ACP200 ACZ330 ACX70 ACW30 AC350 ACZ50M	VP15TF VP20M VP20RT	AH725 AH120 AH130 AH330 AH725 AH730 GH330	PR630 PR830 PR730 PR1225 PR1230 PR1525	WXM15	IC810 IC380 IC830 IC900 IC908 IC910 IC950 IC1008	F25M MP3000	PC3500 PC3600	IN2006 IN1030 IN2004 IN2005 IN2015 IN2030 IN2505 IN2540	
	P30	GC1030 GC2030	KC530M KC725M KC735M	ACP200 ACP300 ACZ50M ACZ330 AC2350 ACX70 ACW30 AC350	VP30RT	AH740 AH130 AH140	PR630 PR660 PR830 PR1230	WXM35	IC300 IC328 IC830 IC900 IC928 IC350 IC808 IC908	F30M MP3000	PC3500 PC3600 PC5300 PC3545 PC9570T	IN1030 IN2005 IN2015 IN2030 IN2035 IN2040 IN2505 IN2530 IN4035	
	P40	GC1030	KC735M	ACP300 ACZ350		AH140 AH750		WXP45 WSP45 WSP46	IC300 IC328 IC928	F40M	PC5300 PC3545	IN2035 IN2040	
	M Stainless Steel Rostfreier Stahl	M10	GC1020	KC522M KC610M KC643M KC715M	ACZ20W ACZ350 EH20Z	AH330 GH110 GH130	PR730 PR1225 PR660 PR1525		PR730 PR660 PR1225 PR1525	F15M	PC8110		IN2505
		M20	GC1020 GC1025 GC1030 GC203	KC522M KC525M KC610M KC715M KC725M	ACP200 ACZ50M ACZ20M ACZ350 EH20Z AC350	VP15TF VP20RT	AH725 AH730 GH110	PR730 PR1025 PR660 PR1225 PR1525	WXM15	PR730 PR660 PR1025 PR1225 PR1525	F25M MP3000	PC5300 PC8110 PC9530	IN2005 IN2015 IN2505
		M30	GC1040 GC203	KC525M KC530M KC725M KC735M	ACP300 ACZ50M ACX80 AC350	VP30RT	AH740 AH120 AH130 GH330 GH340				F30M MP3000	PC9530 PC3545 PC9570T	IN1030 IN2015 IN2030 IN2035 IN2530 IN4035
		M40	GC1040	KC530M KC735M	ACP300 ACX80		AH140 AH750 GH330 GH340		WSM35 WSM36 WXM35		F40M	PC3545	IN1030 IN2030 IN2035 IN2530 IN4035
	K Cast Iron · Guss	K05	GC1010	KC510M	ACZ10M ACZ120 ACZ310		AH330	PR905 PR1210 PR1510			MH1000	PC8110	IN2510
		K10	GC1010	KC510M KC520M KC620M KC643M	EH20Z ACZ310		AH120 AH330 AH725	PR905 PR1210 PR1510	WXH15 WHH15 WXM15	IC810 IC950 IC1008	F15M MK2000	PC6510	IN2004 IN2010 IN2510
K20		GC1020	KC520M KC620M KC725M	ACK300 EH20Z ACX80 ACW30	VP15TF	GH130		WKK25	IC328 IC830 IC950 IC350 IC808 IC908 IC1008	F25M MK2000 MO3000	PC6510 PC5300	IN1030 IN2004 IN2010 IN2015 IN2030 IN2505	
K30		GC1020	KC620M KC725M	ACK300 ACZ50M					IC328 IC830 IC900 IC908 IC350 IC808 IC908	F30M F40M MP3000	PC5300 PC9570T	IN2005 IN2015 IN2030 IN2505	

General Technical Inform ▪ Allgemeine Technische Info

PVD milling grades · PVD Fräsen Klasse

Material / Class	ZCC-CT	Sandvik	Kennametal	Sumitomo	Mitsubishi	Toshiba Tungaloy	Kyocera	Walter	Iscar	SECO	Korloy	Ingersoll Tague Tec
S Super alloys Ti-Legierung	S05									MH1000 F15M	PC8110	
	S10	YBG102 YBG202 YBG205		ACZ20W	VP15TF		PR905 PR1210 PR1510		IC808	NH1000 F15M F25M	PC5300	
	S20	YBG202 YBG205	S30T GC1025 GC1030 GC2030	ACZ20W			PR905 PR1210 PR1510		IC908 IC380 IC900 IC903 IC908 IC928 IC830 IC808	F25M F30M	PC5300 PC3545	IN2005 IN2505
S30		GC2030	KC725M KC735M	ACZ50M				WSM35 WSM36 WSP45 WSP46 WXM35 WXP45	IC328 IC928 IC830	F40M	PC3545	IN1030 IN2030 IN2035 IN2530 IN4035
N05			KC510M							MH1000 F15M		
N Nonferite materials Ne-metalle	N10		KC510M KC620M KC522M	EH20Z				WXN15		MH1000 F15M		
	N20		KC620M KC522M KC525M KC651M							F25M F30M F40M MP3000		
	H05				VP05HT				IC903	MH1000 F15M	PC210F	IN2004 IN2006
H Hadened materiel Hd-metalle	H10	YBG102	KC643M		VP10MF			WXH15 WHH15	IC900 IC808	MK2000 F30M MP3000	PC210F	IN2004 IN2005 IN2006
	H20	YBG202	GC1010 GC1025 GC1030		VP15TF				IC810 IC908	F30M F40M MK2000 MP3000		



Uncoated milling grades - Unbeschichtet Fräsen Klasse

ISO	ZCC-CT	Sandvik	Kennametal	Sumitomo	Mitsubishi	Toshiba Tungaloy	Walter	Kyocera	Iscar	SECO	Korloy	Ingersoll Tague Tec
N Nonferriete Mat. Ne-metalle	N01	H10	K115M K110M				WK10		IC20N		H01	IN04S
	N10		K313	EH520	HTi10		WKM	GW25	IC08	H15	G10	IN10K IN05S
	N20	H13A H10F	KMF	EH520	TF15		KMG40		IC28	H25		IN15K

1

175.32-22	A103
175.32-24	A103
175.32-25	A103
175.32-28	A103

A

APKT-ALH	B205
APKT-APF	B205
APKT-APM	B205
APKT-KM/PM	B207
APKT-LH	B205
APKT-PF	B205
APKT-PM	B205
APKT-PR	B205
ANGX*PNR-GM	B204
ANGX*PNR-LH	B204
APMT_PDER	B206
APMT_PDR	B206

C

CCGT	A149
CCGT-SF	A105
CCGT-USF	A105
CCGW	A142
CCGW(PCD)	A150
CCGX-LC	A108
CCGX-LH	A108
CCMT-AHF	A106
CCMT-EF	A107
CCMT-EM	A107
CCMT-HF	A106
CCMT-HM	A107
CCMT-HR	A108
CCMT-TC	A108
CCMW	A108
CNE-A	B207
CNE-B	B207
CNEG-NF	A67
CNGA	A137
CNGA	A160
CNGN	A161
CNGN(CBN)	A146
CNGX	A162
CNMA	A72
CNMG	A72
CNMG-ADF	A66
CNMG-DF	A66
CNMG-DM	A68
CNMG-DR	A69
CNMG-EF	A66
CNMG-EG	A68
CNMG-EM	A68
CNMG-ER	A70

CNMG-NM	A69
CNMG-PM	A67
CNMG-SF	A66
CNMG-SNR	A69
CNMG-TC	A69
CNMG-WG	A66
CNMG-ZM	A68
CNMM	A71
CNMM-DR	A70
CNMM-ER	A70
CNMM-HDR	A71
CNMM-HPR	A71
CNMM-LR	A70
CPGT	A106
CPGT-SF	A109
CPGW	A109
CPMT-HF	A109
CPMT-HM	A109

D

DCGT-SF	A110
DCGT-USF	A110
DCGW	A143
DCGX-LC	A112
DCGX-LH	A112
DCGT	A151
DCGT-SF	A110
DCGT-USF	A110
DCMT-AHF	A110
DCMT-EF	A111
DCMT-EM	A111
DCMT-HF	A111
DCMT-HM	A111
DCMT-HR	A112
DCMW	A112
DCGW(PCD)	A152
DNEG-NF	A74
DNEG-NGF	A74
DNGA	A138
DNGA	A162
DNGN	A163
DNGN(CBN)	A146
DNGX	A163
DNMA	A77
DNMG	A78
DNMG-ADF	A73
DNMG-DF	A73
DNMG-DM	A75
DNMG-DR	A76
DNMG-EF	A74
DNMG-EG	A76
DNMG-EM	A76
DNMG-ER	A77
DNMG-FM	A74
DNMG-NM	A76
DNMG-PM	A75
DNMG-SF	A73

DNMG-SNR	A76
DNMG-TC	A76
DNMG-ZM	A75
DNMM-DR	A78
DNMM-ER	A78
DNMM-HDR	A78
DNMM-LR	A78
DNMX-WG	A73
DPGT-SF	A113
DPGT-USF	A113
DPMW	A113

H

HNEX-DF	B208
HNEX-DM	B208
HNEX-DR	B208
HNGX-MR	B208
HNGX-HDR	B208

K

KNUX	A102
------	------

L

LNCX	B210
LNE32.534	B209
LNE32:302	B209
LNKT-ZR	B209
LT****N-A(G)	A337
LT****N-BSPT	A340
LT****N-GM	A336
LT****N-NPT	A341
LT****N-UN	A339
LT****N-W	A338
LT****W-A(G)	A337
LT****W-BSPT	A340
LT****W-GM	A335
LT****W-NPT	A341
LT****W-UN	A339
LT****W-W	A338

M

MPHT	B210
------	------

O

OFKR-DF	B211
OFKR-DM	B211
OFKR-LH	B211
OFKT-DF	B211
OFKT-DM	B211
OFKT-LH	B211
ONHU-PF	B212
ONHU-PM	B212

Index

Insert / WSP

ONHU-GM B212
ONHU-W B212

P

PNEG-CF B213
PNEG-CM B213
PNEG-CR B213
PNEG-PF B213
PNEG-PM B213
PNEG-PR B213

Q

QC**R/L B214/215
QC**R/L A300
QC**R/L***R A304

R

RCGT A114
RCGX-LH A114
RCKT-DM B216
RCKT-DR B216
RCKT-ER B216
RCKT-NM B216
RCMG A101
RCMT A114
RCMX A115
RDKW B217
RNGN A168
RNGN(CBN) A148
RNMG A101
ROHX B218
RT****N-A(G) A337
RT****N-A(G)B A352
RT****N-AC A346
RT****N-AP A348
RT****N-BSPT A340
RT****N-BSPTB A355
RT****N-BUT A350
RT****N-GM A336
RT****N-GMB A351
RT****N-NPT A341
RT****N-NPTB A356
RT****N-NPTF A342
RT****N-R A343
RT****N-RD A349
RT****N-STAC A347
RT****N-TR A345
RT****N-UN A339
RT****N-UNB A354
RT****N-W A338
RT****N-WB A353
RT****W-A(G) A337
RT****W-A(G)B A352
RT****W-AC A346
RT****W-AP A348

RT****W-BSPT A340
RT****W-BSPTB A355
RT****W-BUT A350
RT****W-GM A335
RT****W-GMB A351
RT****W-MJ A344
RT****W-NPT A341
RT****W-NPTB A356
RT****W-NPTF A342
RT****W-R A343
RT****W-RD A349
RT****W-STAC A347
RT****W-TR A345
RT****W-UN A339
RT****W-UNB A354
RT****W-UNJ A344
RT****W-W A338
RT****W-WB A353

S

SCGX-LC A117
SCGX-LH A117
SCMT A116
SCMT-AHF A116
SCMT-EF A116
SCMT-EM A116
SCMT-HF A116
SCMT-HM A117
SCMT-HR A117
SCMW B218
SDMT B219
SDMT-DM B219
SDMT-PM B222
SEEN B220
SEET-CF B220
SEET-CM B220
SEET-CR B220
SEET-DF B220
SEET-DM B220
SEET-DR B220
SEET-EF B220
SEET-EM B220
SEET-LH B221
SEET-LH B221
SEET_PER-* B220
SEET-W B222
SEKN B222
SEKR B223
SNEG-GM/GR B223
SNEG-E B223
SNEG-W A139
SNGA A164
SNGA A165
SNGN A147
SNGN(CBN) A164
SNGX B223
SNKN A86

SNMA A85
SNMG A79
SNMG-ADF A79
SNMG-DF A81
SNMG-DM A82
SNMG-DR A80
SNMG-EF A81
SNMG-EM A81
SNMG-EG A82
SNMG-ER A82
SNMG-NM A80
SNMG-PM A79
SNMG-SF A81
SNMG-TC A85
SNMM A83
SNMM-DR A84
SNMM-ER A84
SNMM-HDR A84
SNMM-HPR A83
SNMM-LR A87
SNUN B224
SPAN B224
SPCN B227
SPEX B229
SPGN C134
SPGT-EM C134
SPGT-PM B225
SPKN B226
SPKR-GM B228
SPKT B226
SPKW B228
SPMR B228
SPMT B228
SPMT-HT B228
SPMT-KM B228
SPMT-KT B228
SPMT-PM A118
SPMW B229
SPUN

T

TBGGH-L A118
TBGGH-L A153
TCGT A119
TCGT-SF A119
TCGT-USF A144
TCGW A154
TCGW(PCD) A123
TCGX-LC A123
TCGX-LH A122
TCMT A120
TCMT-AHF A121
TCMT-EF A121
TCMT-EM A120
TCMT-HF A122
TCMT-HM A122
TCMT-HR A122
TCMW A140

TNGA A166
 TNGA A167
 TNGN A94
 TNMA A93
 TNMG A88
 TNMG-ADF A88
 TNMG-DF A90
 TNMG-DM A91
 TNMG-DR A89
 TNMG-EF A91
 TNMG-EM A91
 TNMG-EG A92
 TNMG-ER A89
 TNMG-FM A90
 TNMG-PM A88
 TNMG-SF A91
 TNMG-TC A90
 TNMG-ZM A94
 TNMM A92
 TNMM-DR A93
 TNMM-HDR A92
 TNMM-LR A104
 TNMX A88
 TNMX-WG B230
 TPAN B230
 TPCN A124
 TPGH-L A124
 TPGT-SF B231
 TPKN B232
 TPMR B232
 TPUN

V

VBET-NF A127
 VBET-NGF A128
 VBET-NGF A155
 VBGT A127
 VBGT-SF A145
 VBGW A155
 VBGW(PCD) A127
 VBMT-AHF A127
 VBMT-EF A128
 VBMT-EM A127
 VBMT-HF A128
 VBMT-HM A128
 VBMT-HR A128
 VBMT-SNR A128
 VBMW A125
 VCGT A156
 VCGT(PCD) A125
 VCGT-HF A125
 VCGT-NF A125
 VCGT-SF A125
 VCGT-USF A145
 VCGW A156
 VCGW(PCD) A126
 VCGX-LC A126

VCGX-LH A129
 VCMT-EM A129
 VCMT-EF A129
 VPGT-USF A95
 VNEG-NF A95
 VNEG-NGF A141
 VNGA A96
 VNMG A95
 VNMG-ADF A95
 VNMG-DF A96
 VNMG-DM A95
 VNMG-EF A96
 VNMG-EM A96
 VNMG-NM A96
 VNMG-PM A95
 VNMG-SF A96
 VNMG-SNR A96
 VNMG-TC A96
 VNMG-ZM

W

WCMX C135
 WCMX A130
 WCMX-53 C135
 WCMX-53 C135
 WCMX-PG A98
 WNEG-NF A141
 WNGA A168
 WNGA A147
 WNGN(CBN) A100
 WNMA A97
 WNMG-ADF A97
 WNMG-DF A99
 WNMG-DM A100
 WNMG-DR A98
 WNMG-EF A99
 WNMG-EM A99
 WNMG-EG A98
 WNMG-NF A100
 WNMG-NM A99
 WNMG-PM A97
 WNMG-SF A99
 WNMG-TC A98
 WNMG-WG A99
 WNMG-ZM B233
 WPGT B233
 WPGT-PM

X

XPHT-GM B233
 XPHT-GM B234
 XSEQ

Y

YNMX A104
 YNUX A104

Z

Z B234
 ZDET A297
 ZIGQ-NM A298
 ZILD-LC A297
 ZIMF-NM B235
 ZOHX-GF B235
 ZOHX-GM A292
 ZP*D-MG A293
 ZP*D-MG* A292
 ZP*S-MG B235
 ZPNT A296
 ZR*D-EG A298
 ZR*D-LH A296
 ZR*D-MG A295
 ZT*D-EG A294
 ZT*D-MG A291
 ZT*D-MM A294
 ZT*S-MG

1

1101SC05	C84-C87
1105SC03	C84-C87
1143SC120	C94
1143SC90	C94
1165PA03	C88-C90
1534SH03	C83
1534SP03C	C63-C66
1534ST03C	C66-C81
1534SU03	C10-C50
1534SU03C	C10-C50
1536ST05C	C66-C81
1536SU05	C06-C50
1536SU05C	C06-C50
1538SU08C	C06-C50
1557SU03	C51
1576PC05	C91-C93
1576PC05C	C91-C93
1579PC15C	C91-C93
1588SL10C	C52-C62
1588SL12C	C52-C62
1588SL15C	C52-C62
1588SL20C	C52-C62
1588SL30C	C52-C62
1634SU03C	C06-C50
1636SU05C	C06-C50
1734SU03C	C06-C50
1636ST05C	C70-C81
1736SU05C	C06-C50

3

3101H7	C144
3102H7	C145
3103H7	C147
3112H7	C146

4

4111	C169
4122A	C156
4122M	C158
4222A	C157
4222M	C158
4201A	C164
4201C	C160
4202A	C166
4202C	C162

5501/5601	B529
5601	B530
5501R302GM	B304
5501R303GM	B330
5501R304GF	B348
5501R38414GM	B501
5502R302GM	B306
5502R303GM	B332
5502R304GF	B350
5502R38414GM	B502
5502R38414GM-R	B504
5502R402NM	B452
5502R453GM	B334
5502R55MHH	B414
5508R454GM	B352
5565R302GF	B368
5565R302GH	B420
5565R302HH	B422
5565R302NH	B483
5566R302GF	B370
5566R302GH	B421
5566R302HH	B423
5566R302NH	B484
5566R304HH	B438
5585R554HHR	B443
5586R554HHR	B444
5589R45MGFR	B362
5601R302GM	B305
5601R303GM	B331
5601R304GF	B349
5602R302GM	B307
5602R303GM	B333
5602R304GF	B351
5602R303/304GR	B391
5602R305GR	B391
5602R38414GM-R	B505
5602R38414GM	B503
5602R453GM	B335
5602R454GM	B353
5665R202GM	B369

A

AL-2B	B485
AL-1E	B465
AL-2E	B467
AL-2EL	B468
AL-3E	B472
AL-3EL	B473
AL-2R-AIR	B489
AL-2RL-AIR	B490
AL-3R-AIR	B493
AL-3RL-AIR	B494

AL-3W	B481
ALG-2E	B470
ALG-3E	B475
ALP-3E	B477
ALP-4E	B479

B

BMR01	B119
BMR02	B121
BMR03	B123-B126
BMR04	B135-B136

C

C16M-QBDR/L	A308
C40X-Q*DR/L	A321
CCLNR/L	A235
CDJNR/L	A236
CKJNR/L	A234
CKNNR/L	A234
C(E)***-SCLPR/L	A272
C(E)***-SDQPR/L	A273
C(E)***-SDUPR/L	A274
C(E)***-STUPR/L	A275
C(E)***-STFCR/L	A276
C(E)***-STFPR/L	A276
C(E)***-SVQCR/L	A277
C(E)***-SVUCR/L	A278
CMA01	B172
CMD01	B173
CMZ01	B171
CRDNN	A238
CSDNN	A238
CSKNR/L	A237
CSRNR/L	A237
CTJNR/L	A235
CTUNR/L	A236
C***-Q*DR/L	A321

D

DCLNR/L	A181
DDJNR/L	A182
DSBNR/L	A183
DTGNR/L	A184
DVJNR/L	A186
DVVNN	A185
DWLNR/L	A187

E

EMP01	B95
EMP02	B102
EMP03	B106
EMP04	B107
EMP05	B111
EMP13	B115

F

FMA01	B28
FMA02	B29
FMA03	B33
FMA04(OFKT)	B36
FMA04(OFKR)	B40
FMA07	B43
FMA11	B47
FMA12	B51
FMD02(PN11)	B54
FMD02(HN09)	B57
FMD03	B59
FME02	B62
FME03	B64
FME04	B68
FMP01	B70
FMP02	B72
FMP03	B78
FMR01	B80
FMR02	B83
FMR03	B86
FMR04	B90

G

G*-QCH	B198,B199
GM-2B	B371
GM-2BFP	B373
GM-2BL	B372
GM-2BP	B378-B379
GM-2BS	B377
GM-2E	B308
GM-2EFP	B311
GM-2EL	B309
GM-2EP	B322-B323
GM-2ES	B324
GM-2EX	B310
GM-2F	B312
GM-2FL	B313
GM-2R	B386
GM-3E	B328
GM-3EL	B329
GM-4B	B383
GM-4BL	B384

GM-4E	B345
GM-4EFP	B347
GM-4E-G	B340
GM-4EL	B346
GM-4EL-G	B342
GM-4EX-G	B344
GM-4F-G	B341
GM-4FL-G	B343
GM-4R	B388
GM-4RL	B389
GM-4W	B392
GM-6E	B363
GM-6EL	B364
GQC**R/L	A323

H

HM-2B	B424
HM-2BFP	B426
HM-2BL	B425
HM-2BP	B433-B434
HM-2BS	B432
HM-2E	B399
HM-2EFP	B400
HM-2EP	B401-B402
HM-2ES	B403
HM-4B	B439
HM-4BL	B440
HM-4E	B409
HM-4EFP	B411
HM-4EL	B410
HM-4R	B445
HM-4RF	B446
HM-4RP	B447
HM-6E	B415
HM-6EL	B416
HMP01	B166-B167
HMP01 EC	B168

J

JCLNR/L	A239
JDJNR/L	A239
JSDNN	A240

M

MCBNR/L	A200
MCLNR/L	A201
MDJNR/L	A202
MDPNN	A203
MRDNN	A215
MRGNR/L	A215
MSBNR/L	A204

MSDNN	A207
MSKNR/L	A206
MSRNR/L	A205
MTFNR/L	A211
MTGNR/L	A208
MTJNR/L	A209
MTJNR/L-Z	A210
MVJNR/L	A213
MVVNN	A212
MWLNR/L	A214

N

NM-2B	B460
NM-2BP	B462
NM-2E	B453
NM-2EP	B456
NM-4E	B458

P

PCBNR/L	A188
PCLNR/L	A189
PDJNR/L	A190
PDNNR/L	A191
PM-2B	B279
PM-2BC	B282-285
PM-2BFP	B281
PM-2BL	B280
PM-2E	B264
PM-2EL	B265
PM-2R	B293
PM-4B	B290
PM-4BL	B291
PM-4E	B270
PM-4E-G	B267
PM-4EL	B271
PM-4EL-G	B268
PM-4EX-G	B269
PM-4H	B298
PM-4HL	B299
PM-4R	B295
PM-4RL	B296
PM-6E	B275
PM-6EL	B276
PSBNR/L	A192
PSDNN	A193
PSKNR/L	A194
PSSNR/L	A195
PTFNR/L	A196
PTGNR/L	A198
PTTNR/L	A197
PWLNR/L	A199

Q

QCH-APKT	B186
QCH-RD	B192,B194
QCH-SDMT	B182
QCH-WPGT	B184
QCH-XPHT	B179
QCH-ZOHX	B196
QEBDR/L	A308
QECDR/L	A310
QE*SR/L	A311
QE*S**N	A312
QE**R/L	A309
QF*DR/L	A319-A320
QF**R/L	A313-A314
QF**RR/LL	A315-A318
QX*DR/L	A310
QZS*	A312

S

SCACR/L	A216
SCLCR/L	A217
SDACR/L	A218
SDJCR/L	A219
SDNCN	A220
SMP01	B143
SMP03	B146
SMP05	B149
SNR/L	A359
SNR****B	A360
SRDCN	A232
SRGCR/L	A233
SSBCR/L	A226
SSDCN	A226
SSKCR/L	A227
SSSCR/L	A227
STACR/L	A228
STFCR/L	A228
STGCR/L	A229
STTCR/L	A230
SVABR/L	A222
SVJBR/L	A221
SVJCR/L	A225
SVVBN	A223
SVVCN	A224
SWACR/L	A231
SWR/L	A358
SWR****B	A360
S***-PCLNR/L	A246
S***-PDSNR/L	A248
S***-PDUNR/L	A249
S***-PSKNR/L	A251
S***-PTFNR/L	A252
S***-PWLNR/L	A253

S*K-QC**R/L	A323
S***-SCFCR	A269
S***-SCLCR	A270
S***-SCLCR/L	A254
S***-SCLPR/L	A265
S***-SDQCR/L	A256
S***-SDQPR/L	A266
S***-SDUCR/L	A257
S***-SDUPR/L	A267
S***-SDZCR/L	A258
S***-SSKCR/L	A259
S***-STFCR/L	A260
S***-STUPR/L	A268
S***-SVQBR/L	A263
S***-SVQCR/L	A261
S***-SVUBR/L	A264
S***-SVUCR/L	A262

T

TMP01	B164
-------	------

U

UM-4E	B508
UM-4E-W	B509
UM-4EFP	B513
UM-4EL	B510
UM-4EL-W	B511
UM-4ELP	B512
UM-4R	B518
UM-4RFP	B520
UM-4RL	B519

V









VSM-4E	B524
VSM-4R	B526

X

XMR01	B152,B155
XMP01	B162

Z

ZD03	C130-C131
ZTD02/03	C126-127
ZTD04/05	C128-129

Test Report Versuchsprotokoll		ZCC Cutting Tools Europe GmbH			
Date					
General	Allgemein	End User / Anwender		Distributor / Händler	
Company	Firma				
Contact person	Gesprächspartner				
Machine	Maschine				
Type	Typ				
Producer	Hersteller				
Power (kW)	Leistung (kW)				
Adaptor / Tooling System	Werkzeugaufnahme				
Workpiece	Werkstück				
Material	Werkstoff				
Hardness / Tensile Strength	Härte / Zugfestigkeit N / mm ²				
Heatreatment / Surface	Wärmebeh. / Oberfläche				
Interrupt cutting	Schnittunterbrechungen				
Cutting tools	Werkzeug				
Producer / Supplier	Hersteller (Halter)				
Toolholder / Milling body	Halter Bezeichnung				
Teeth Z	Zähnezahl Z				
Producer / Soppier	Hersteller (Werkzeug)				
Insert type / Tool Nr.	Platten-Typ / Werkzeug Nr.				
Grade	Schneidstoff Sorte				
Solid carbide tools art	Vollhartmetallwerkzeug Nr.				
Cooling	Kühlmittel int. / ext.				
Cutting Data	Schnittdaten				
RPM $n = U / \text{min}$	Drehzahl $n = U / \text{min}$				
Cutting speed $V_c = m / \text{min}$	Schnittgeschw. $V_c = m / \text{min}$				
Feed rate $f = mm / r$	Vorschub $f = mm / U$				
Feed rate $V_f = mm / \text{min}$	Vorschubgeschw. $V_f = mm / \text{min}$				
Depth of cut a_p mm	Schnitttiefe $a_p = mm$				
Depth of cut a_e mm	Schnittbreite $a_e = mm$				
Machining length mm	Eingriffslänge mm				
Cutting time T min	Eingriffszeit T mm				
Results	Ergebnis				
Machined pieces / Edge	Anzahl Werkst. / Schneidkante				
Surface quality	Oberfläche Werkstück				
Flankwear VB	Freiflächenverschleiß VB				
Criteria	Kriterium				
Notch Wear	Kerbverschleiß				
Crater Wear	Kolkverschleiß				
Plastic deformation	Plastische Verformung				
Built-up edge	Aufbauschneidenbildung				
Insert breakage	Plattenbruch				
Cutting edge breakage	Schneidkantenbruch				
Chipforms	Spanformen				
   	    	○	○	○	○
		Conclusion / Zusammenfassung			
Fax: 0049-211-989240-111 E-mail: info@zccct-europe.com		Sign / Unterschrift _____			





Zhuzhou Cemented Carbide Cutting Tools Co., Ltd. (ZCC-CT) is located in Zhuzhou, Hunan province, China and is the largest supplier of carbide tools into the Chinese market. The ZCC-CT cutting tool company is part of the "Zhuzhou cemented carbide Group" who manufacture carbide materials and powders. Both of these companies are part of the "Minmetals Corporation" who mine and produce raw tungsten carbide materials.

Since its foundation in 1953 ZCC-CT has developed rapidly by progressively using highly advanced modern production technology as well as having a highly qualified and committed workforce. With over 2,000 employees the company is now the largest producer of carbide cutting tools in China and one of the leading carbide manufacturers worldwide.

Using this advanced production technology, ZCC-CT products are manufactured to the highest quality standards to maintain a constant quality and high performance. The wide range of products contains indexable carbide inserts (coated and uncoated), inserts of Cermets, CBN, PCD and ceramics, solid carbide cutting tools as well as tool holders and milling bodies. The products are produced to various international standards such as ISO DIN, ANSI, JIS and BSI. Furthermore customised and special carbide product are also offered.



Research and development plays a major and significant role at ZCC-CT. The production facilities use the most sophisticated and advanced equipment available and this is supplied by the leading machine and equipment manufacturers in Germany and Switzerland. A highly qualified and skilled team of engineers in the R&D departments are constantly developing new and improved cutting tools. There is a constant desire to continually enhance the quality, to fulfill the ever increasing market requirements for new and initiative products and to achieve the best possible result for the customers.

The production and administration facilities in China are certified to ISO 9001:2000 and they maintain strict environmental management to ISO 14001:2004 standards.

Since 2003 ZCC Cutting Tools has operated a sales organisation in Europe. This sales and warehousing subsidiary of ZCC-CT is based in Düsseldorf (Germany) and has been progressively build up and expanded by Mr. Quanliang Zhao the European Managing Director.

Sales to all European countries, as well as Russia and Turkey, are controlled and managed from this European central warehouse in Düsseldorf, with the majority of the products being dispatched on the same day of ordering. The business operates under the quality management system for "Distribution and Logistics of Metal Cutting Tools" and is certified with DIN EN ISO 9001:2008.



ZCC Cutting Tools Europe has a constantly growing number of employees covering sales, marketing, warehouse and distribution, technical support, IT, HR and accounting. Our external sales team and our partners from around Europe are there to support you on-site in your production facilities or distribution operations. Our internal, highly qualified, technical application engineering staff are always available to give the customer technical advice and support via telephone, by email or in person. The internal sales team takes care of your enquiries and orders and together with dedicated warehouse staff they ensure that products are dispatched to you as quickly as possible.

The complete team at ZCC Cutting Tools Europe are there to support you and be your competent and efficient partner in the global Cutting Tool Industry.



Zhuzhou Cemented Carbide Cutting Tools Co., Ltd. (ZCC-CT) mit Sitz in Zhuzhou, Hunan, in der Volksrepublik China ist der größte Lieferant von Hartmetallwerkzeugen im chinesischen Markt. ZCC-CT gehört zur „Zhuzhou cemented carbide Group“, die Hartmetall-Produkte und Hartmetall-Pulver herstellt. Beide Unternehmen sind Teil der „Minmetals Corporation“, die Metalle und Mineralien abbaut und mit diesen handelt.

Seit der Gründung 1953 hat sich ZCC Cutting Tools auf dem Gebiet der Hartmetallproduktion durch neueste Technologien sowie hochqualifiziertes Personal zu einem der weltweit führenden Hartmetallhersteller mit mehr als 2.000 Mitarbeitern entwickelt.

Auf Basis der neuesten Produktionstechnologien produziert ZCC-CT Produkte gleichbleibender Qualität auf höchstem Niveau. Die umfangreiche Produktpalette beinhaltet Hartmetallwendeschneidplatten (beschichtet und unbeschichtet), Wendeschneidplatten aus Cermet, CBN, PKD und Keramik, Vollhartmetallwerkzeuge sowie Werkzeughalter und Fräskörper. Die Produkte werden nach verschiedenen internationalen Standards produziert wie z.B. ISO DIN, ANSI, JIS und BSI. Des Weiteren werden auch kundenspezifische Lösungen und spezielle Hartmetallprodukte angeboten.

Forschung und Entwicklung haben bei ZCC-CT einen besonders hohen Stellenwert. Für diesen Bereich werden die weltweit modernsten Anlagen und fortschrittlichsten Maschinen aus Deutschland und der Schweiz genutzt und überdurchschnittlich hohe Investitionen getätigt. Mit gut ausgebildeten Ingenieuren und einem kompetenten Team forscht und entwickelt ZCC Cutting Tools stetig neue und verbesserte Produkte. Das Unternehmen strebt kontinuierlich danach die Qualität zu verbessern, den gestiegenen Anforderungen nach neuen und innovativen Produkten gerecht zu werden und ein bestmögliches Ergebnis für den Kunden zu erreichen.

Die Produktion und Verwaltung in China unterliegt qualitativ der ISO Normen 9001:2008 und im Bereich Umwelt-Management der ISO 14001:2004.

Seit 2003 hat ZCC Cutting Tools eine Vertriebszentrale in Europa. Der Sitz der Niederlassung befindet sich in Düsseldorf (Deutschland) und wurde kontinuierlich vom Geschäftsführer Quanliang Zhao aufgebaut.

Mittlerweile werden von dort alle europäischen Länder und Russland sowie die Türkei betreut. Auch das europäische Zentrallager befindet sich in Düsseldorf, so dass die meisten Artikel noch am Tag der Bestellung an den Kunden verschickt werden. Das Qualitätsmanagementsystem des Unternehmens ist im Bereich „Vertrieb und Logistik von Werkzeugen für die Metallverarbeitung“ nach der DIN EN ISO 9001:2008 zertifiziert.

Die Anzahl der Mitarbeiter im Vertrieb, im technischen Support und in den Bereichen Lager, Marketing, IT, Personal und Buchhaltung wächst bei ZCC Cutting Tools Europe stetig. Unsere Außendienstmitarbeiter und unsere Partner in Europe betreuen Sie vor Ort und unsere Anwendungstechniker stehen Ihnen telefonisch, per E-mail oder auch persönlich mit Rat und Tat beiseite. Das Team im Vertriebsinnendienst kümmert sich um Ihre Anfragen und sorgt zusammen mit den Mitarbeitern im Lager dafür, dass die Bestellungen so schnell wie möglich auf den Weg zum Kunden gebracht werden.

Alle gemeinsam sind wir als ZCC Cutting Tools Europe für Sie da und stehen Ihnen als kompetenter Partner in der globalen Zerspanungsindustrie zur Seite!





Sales center in Europe:
Vertriebszentrale in Europa:

ZCC Cutting Tools Europe GmbH

www.zccct-europe.com

Heltorfer Straße 12 40472 Düsseldorf, Germany

Tel.: +49(0)211-989240-0

Fax: +49(0)211-989240-111

E-mail: Info@zccct-europe.com



© Copyright by ZCC Cutting Tools Europe GmbH
Alle Rechte vorbehalten

Distributor
Vertretung